

# Alphabet Sudoku Game

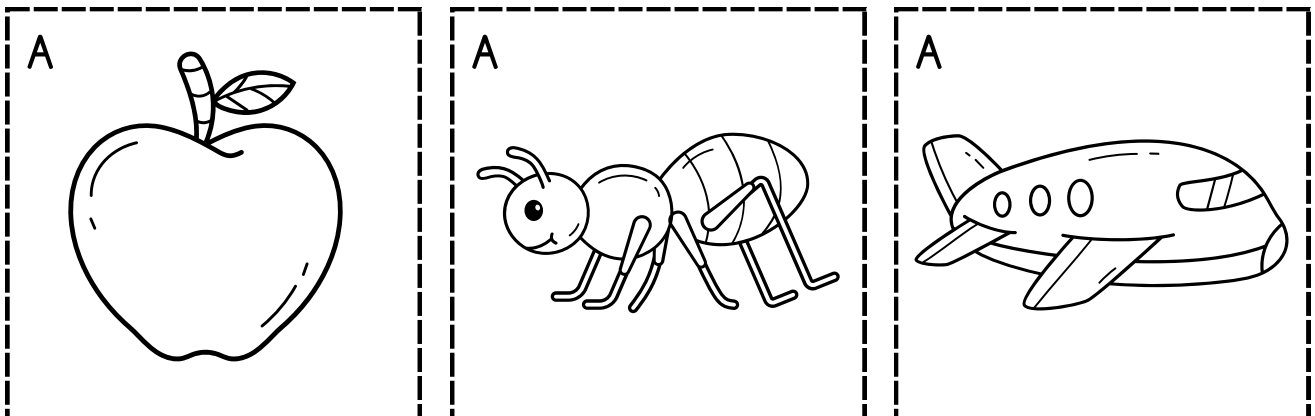

# Alphabet Sudoku Game

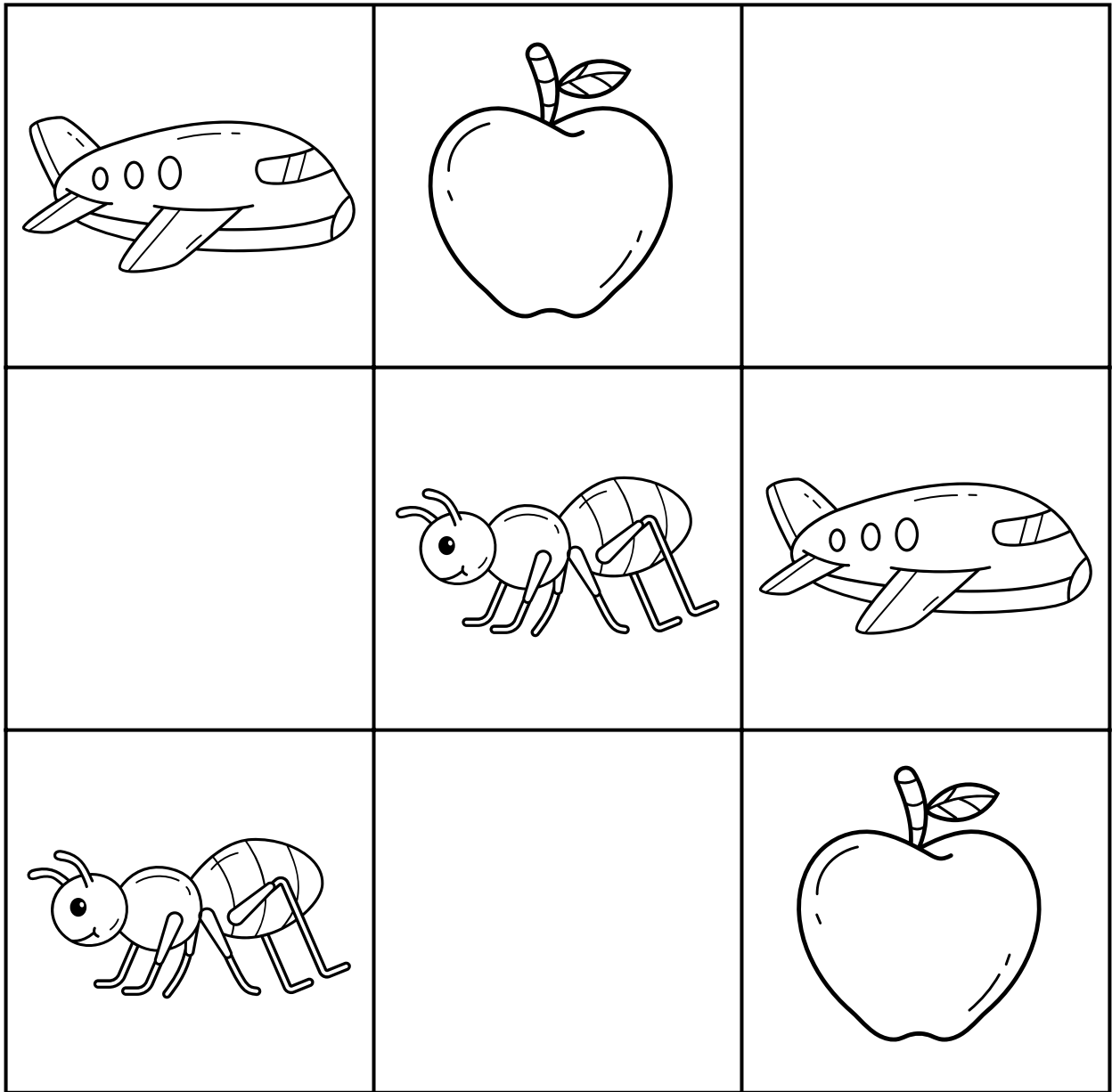
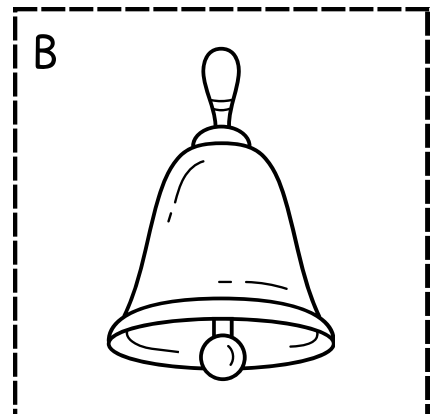
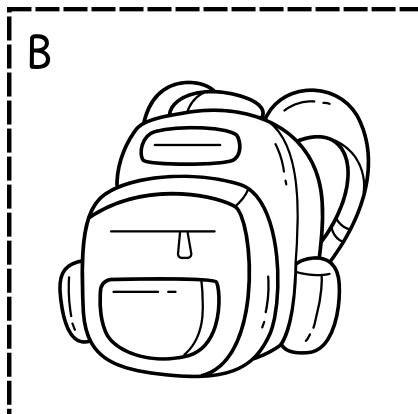
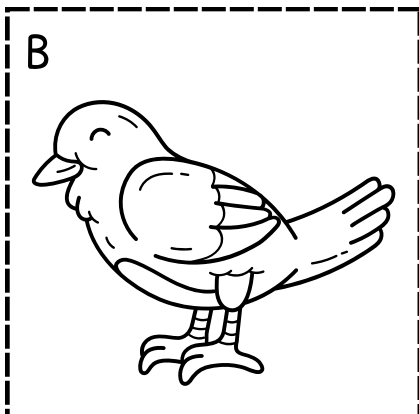
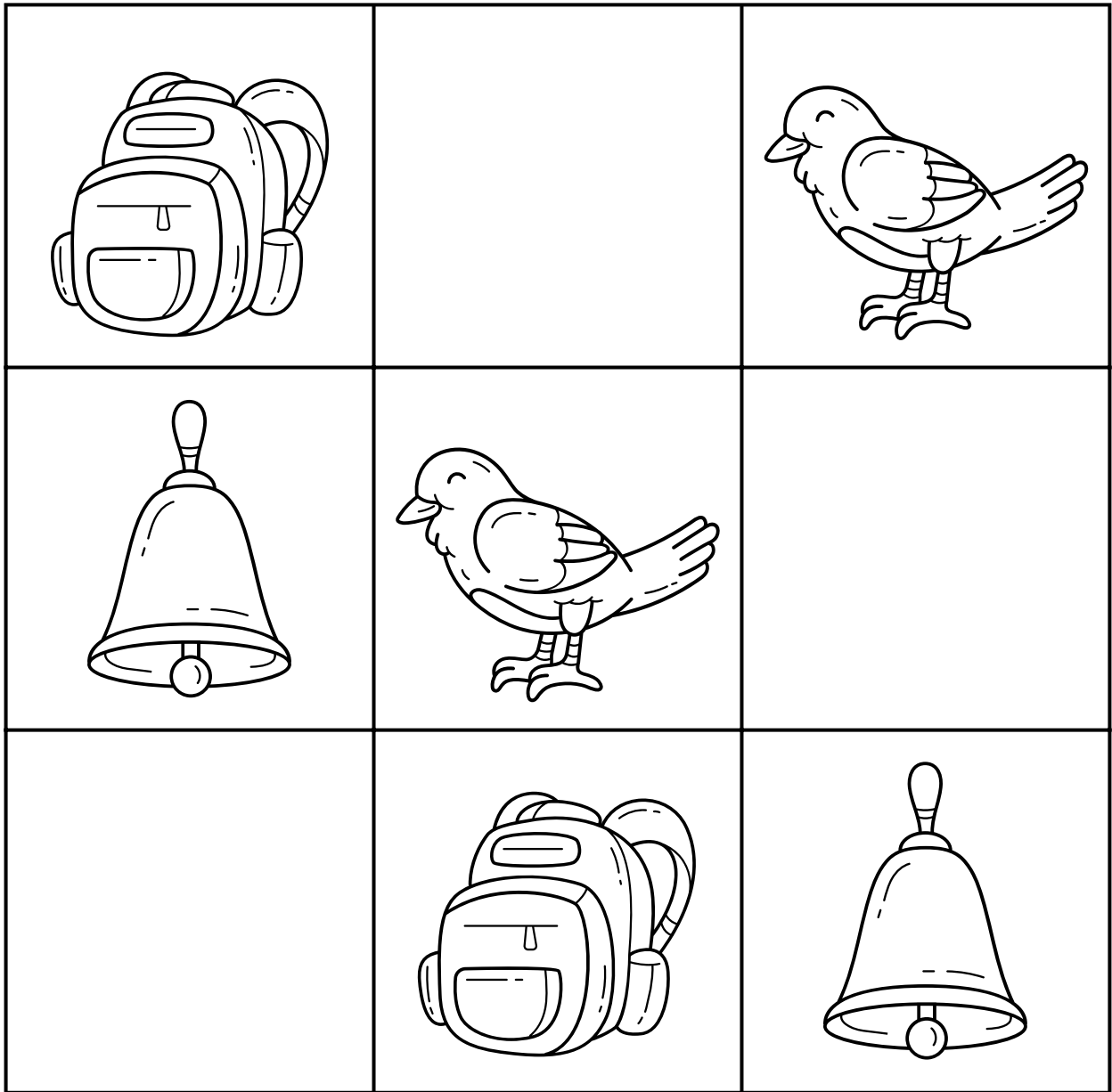

# Alphabet Sudoku Game

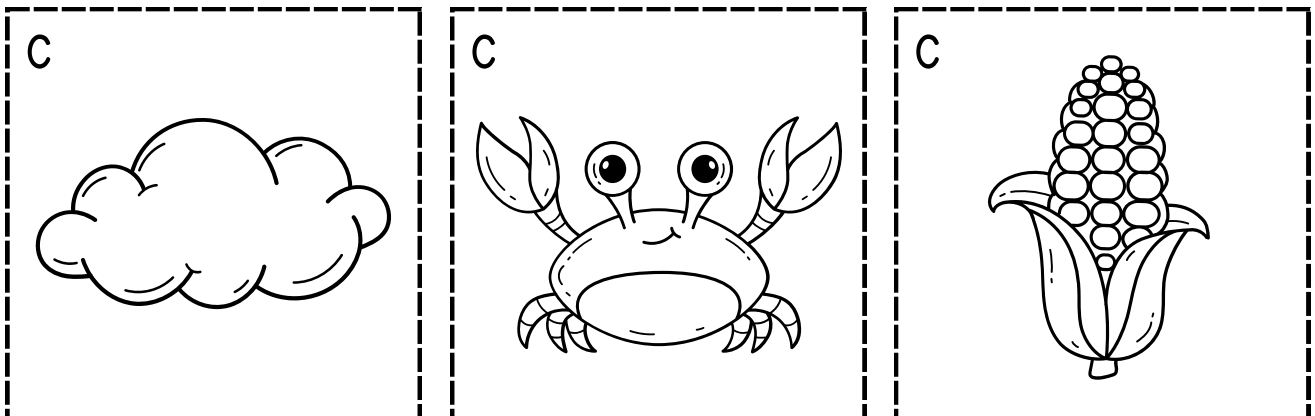
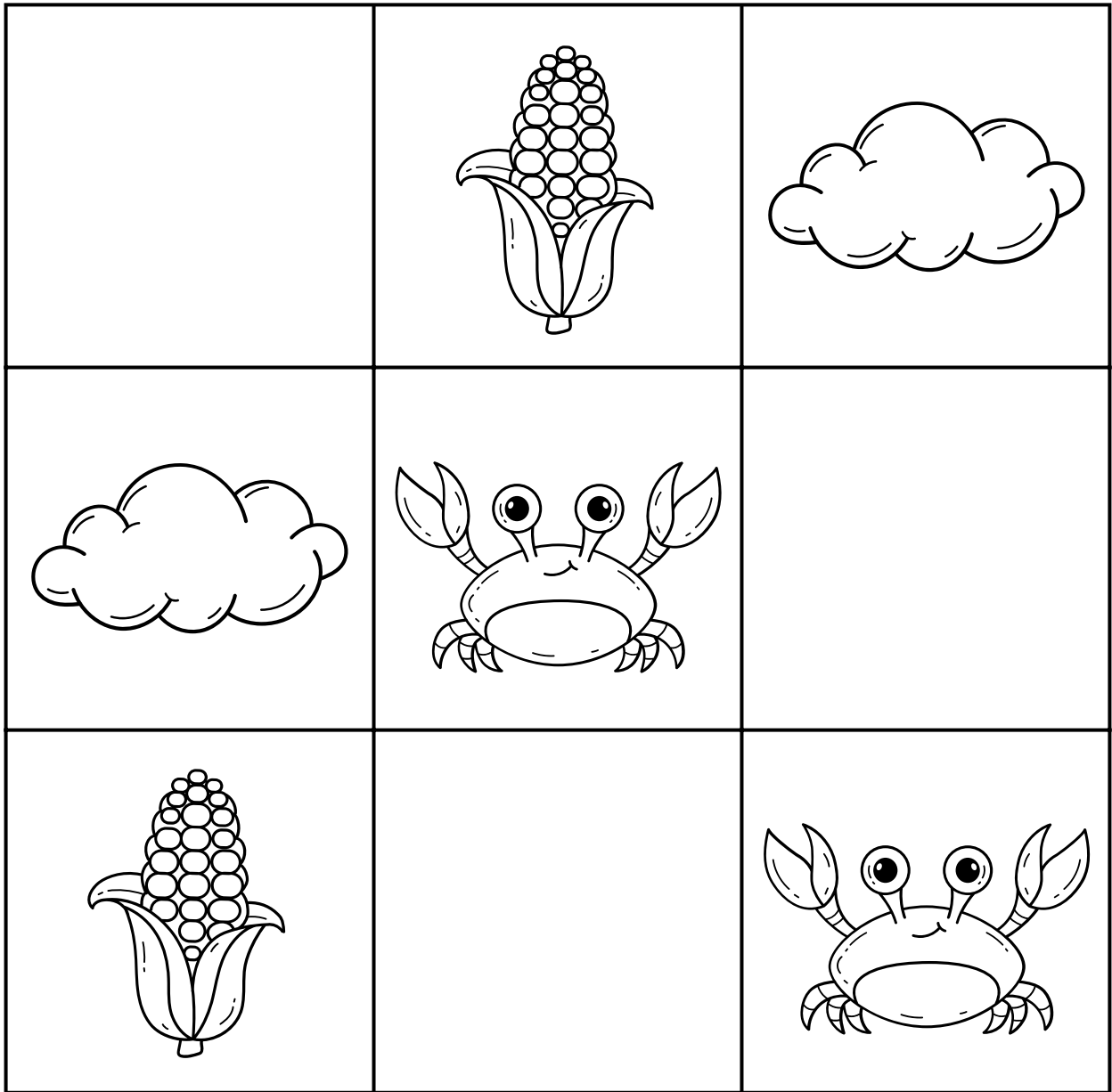

# Alphabet Sudoku Game

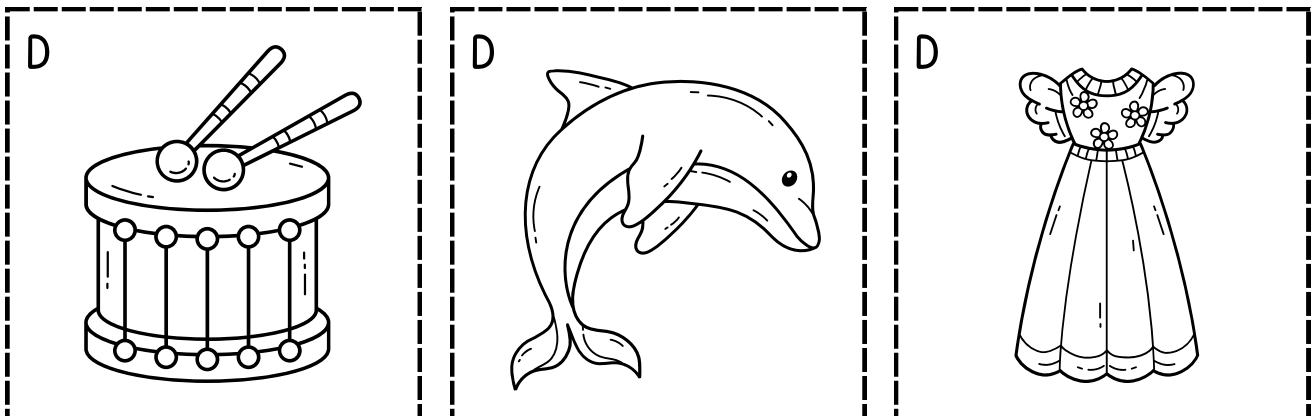
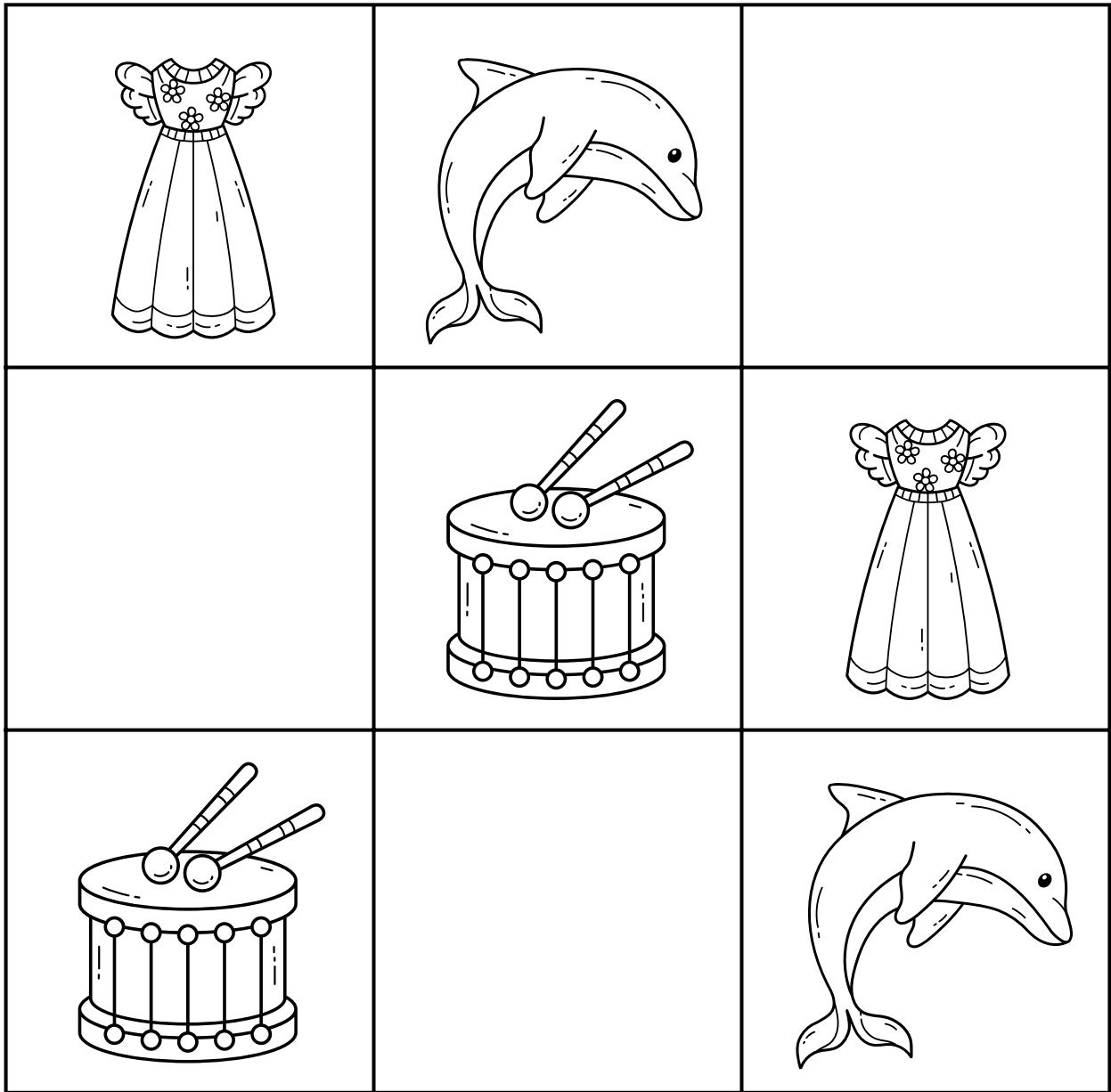

# Alphabet Sudoku Game

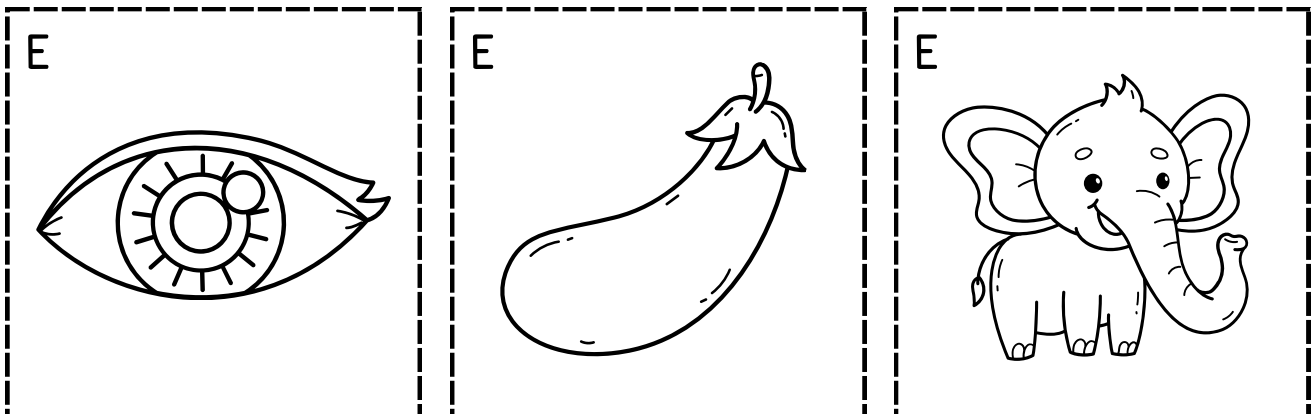
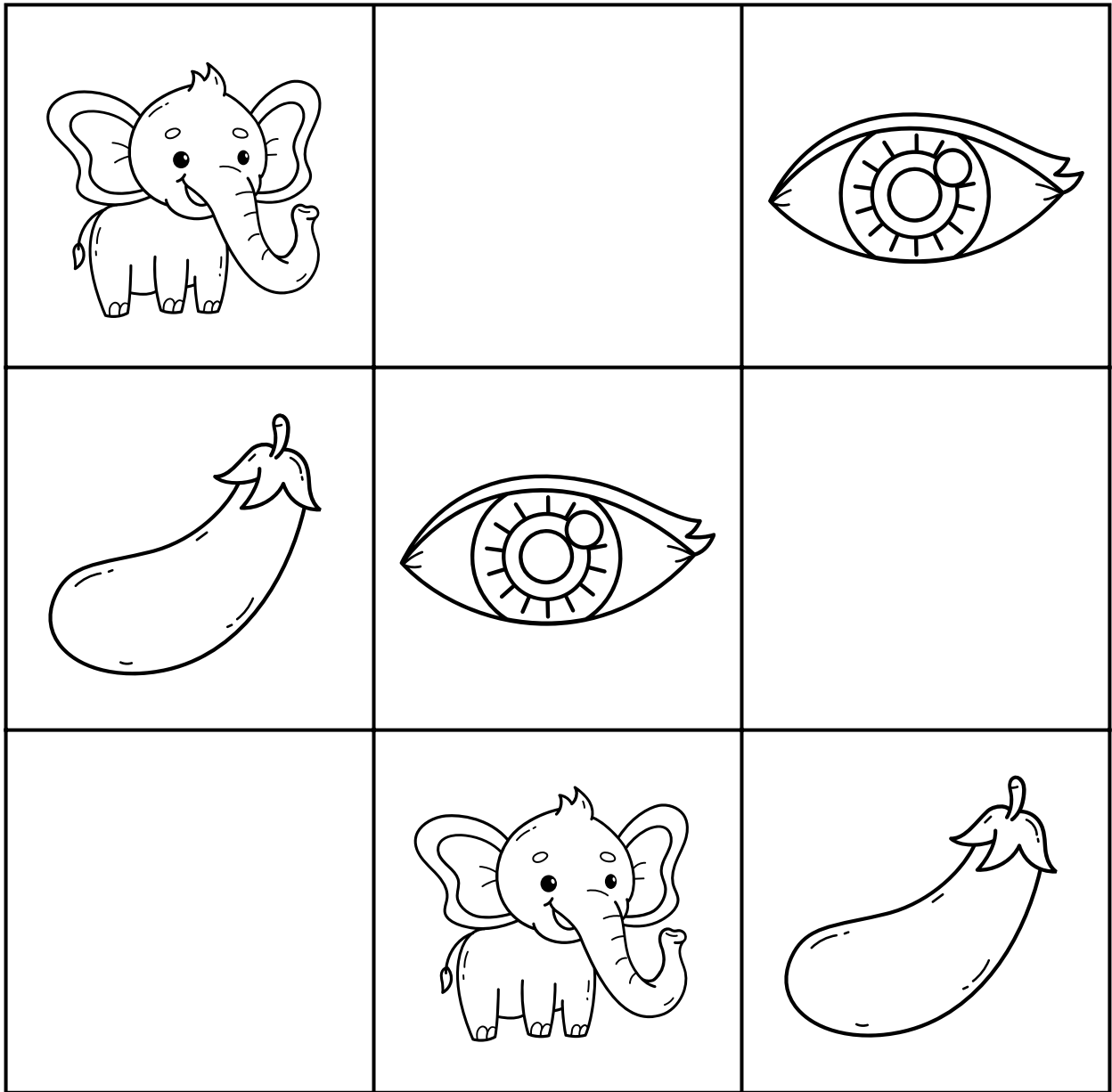

# Alphabet Sudoku Game

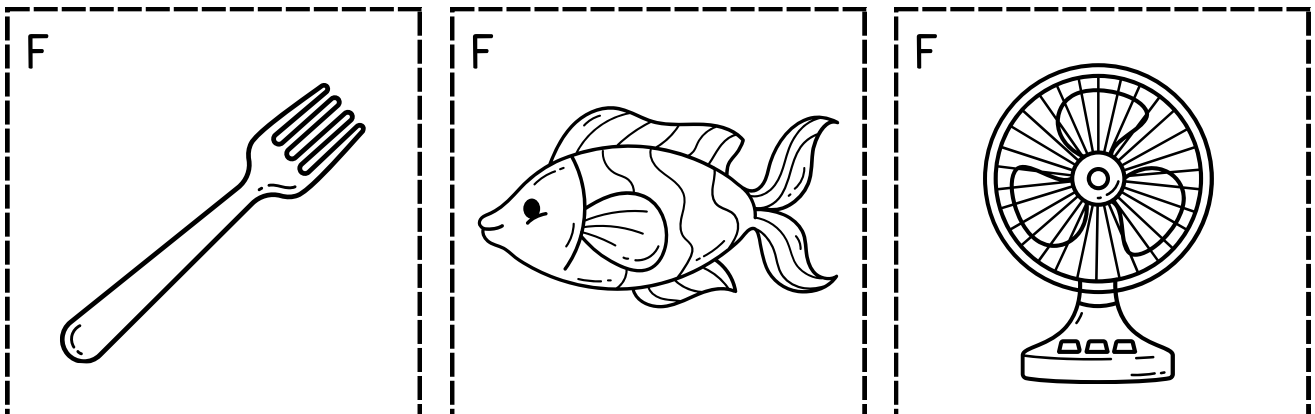
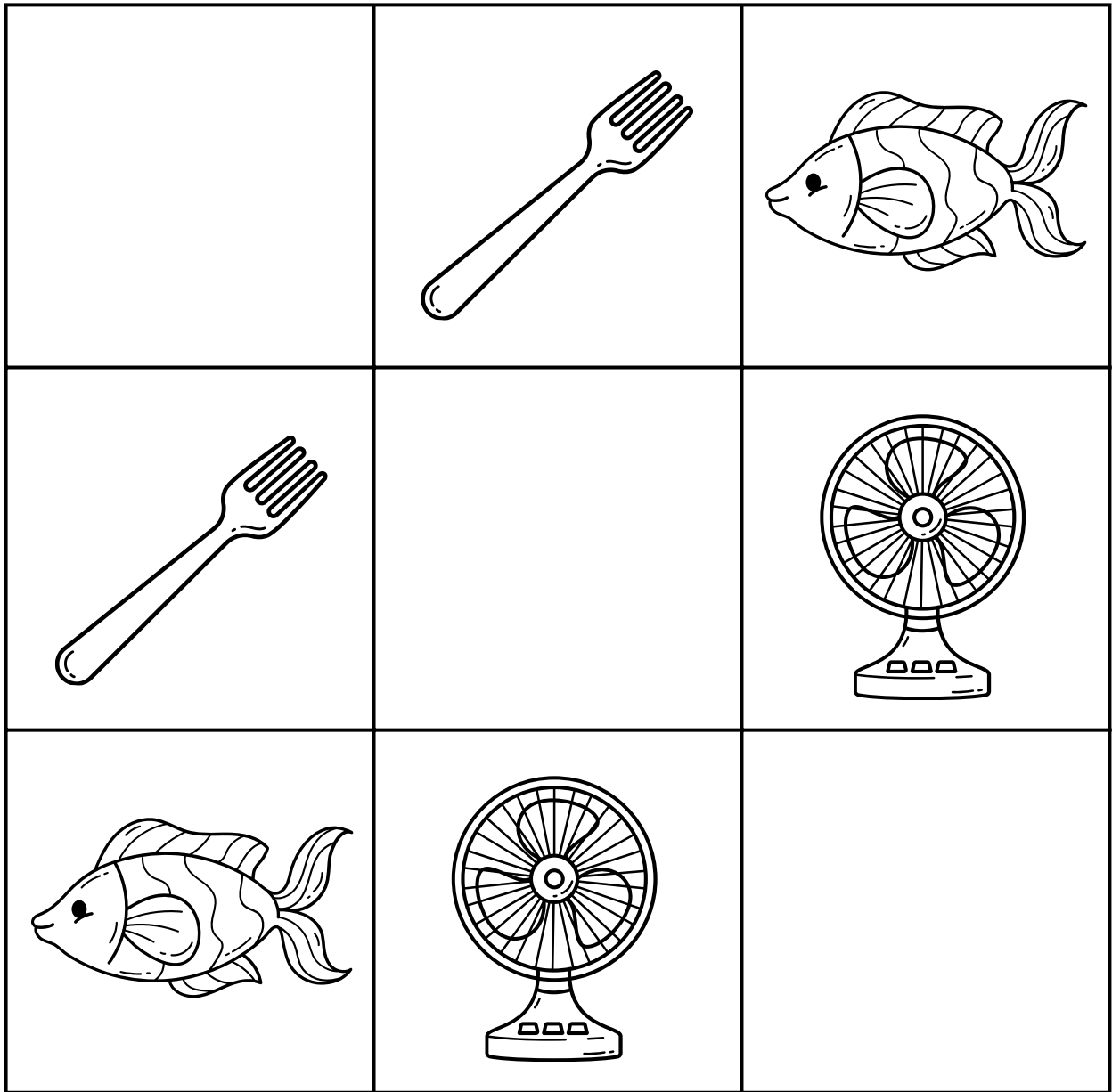

# Alphabet Sudoku Game

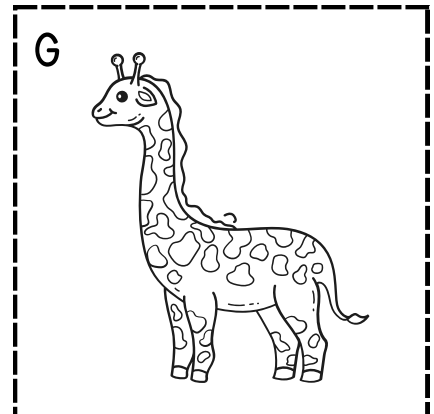
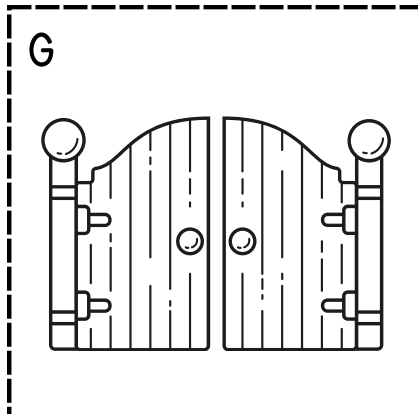
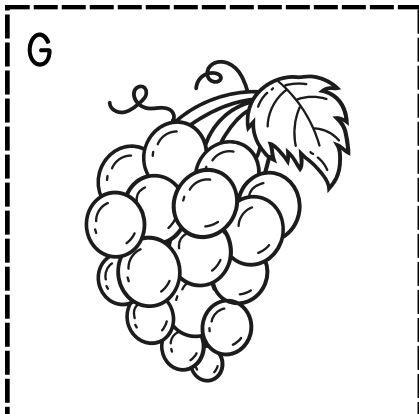
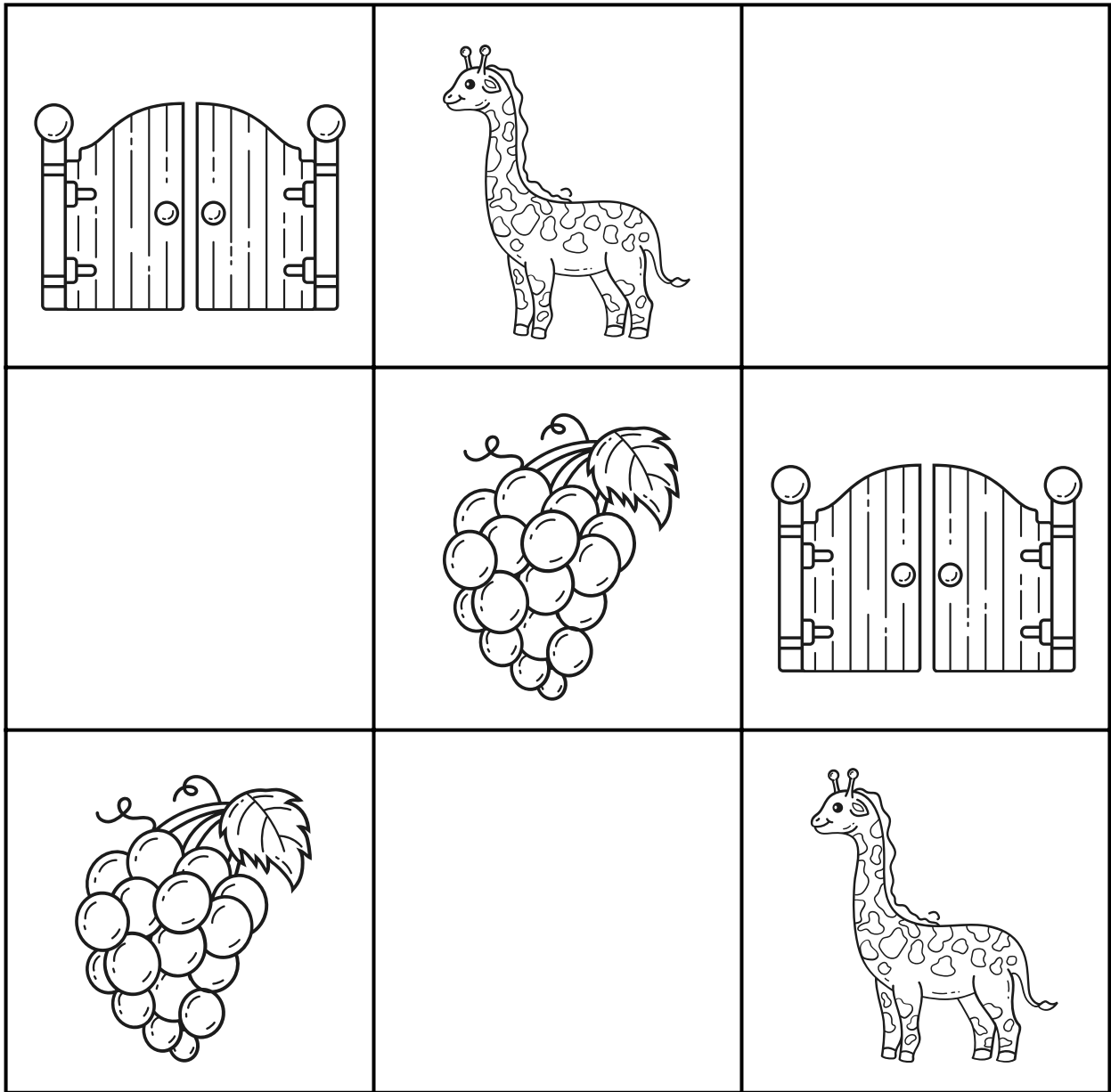

# Alphabet Sudoku Game

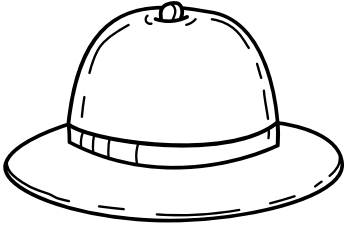
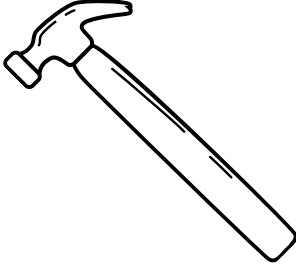
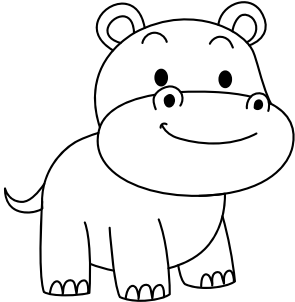
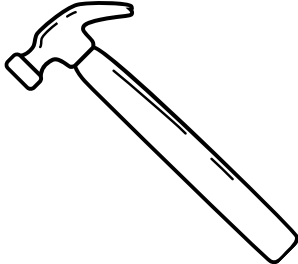
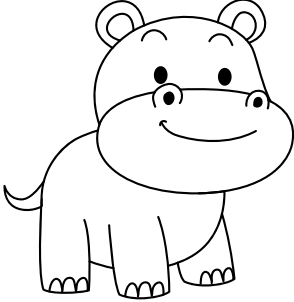
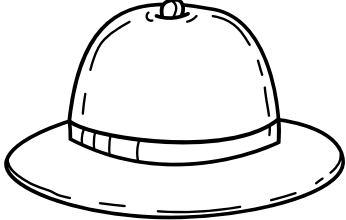

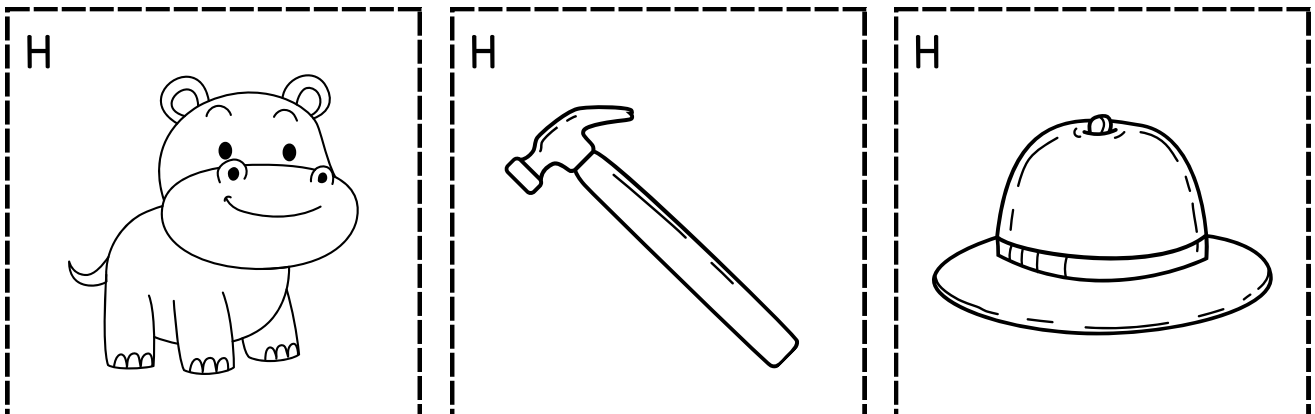

		
		
		

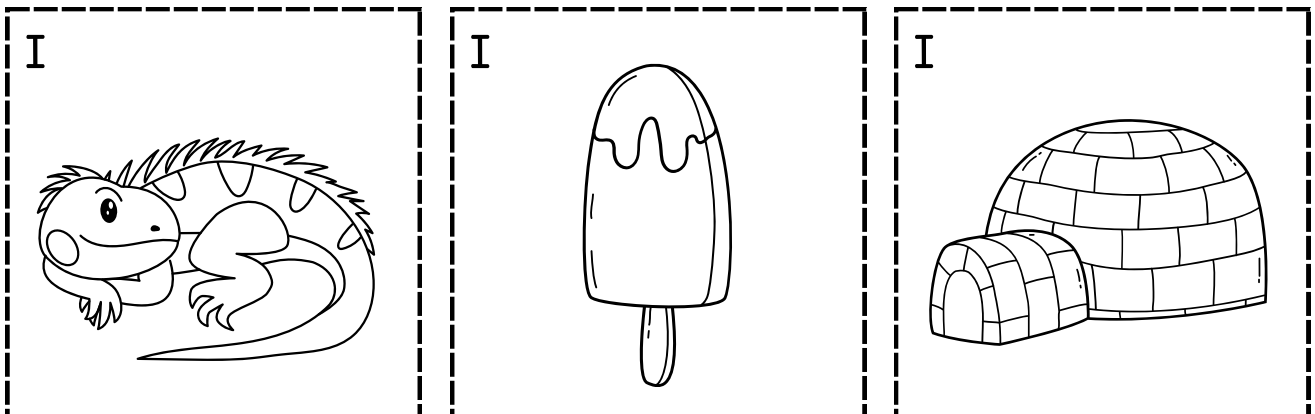
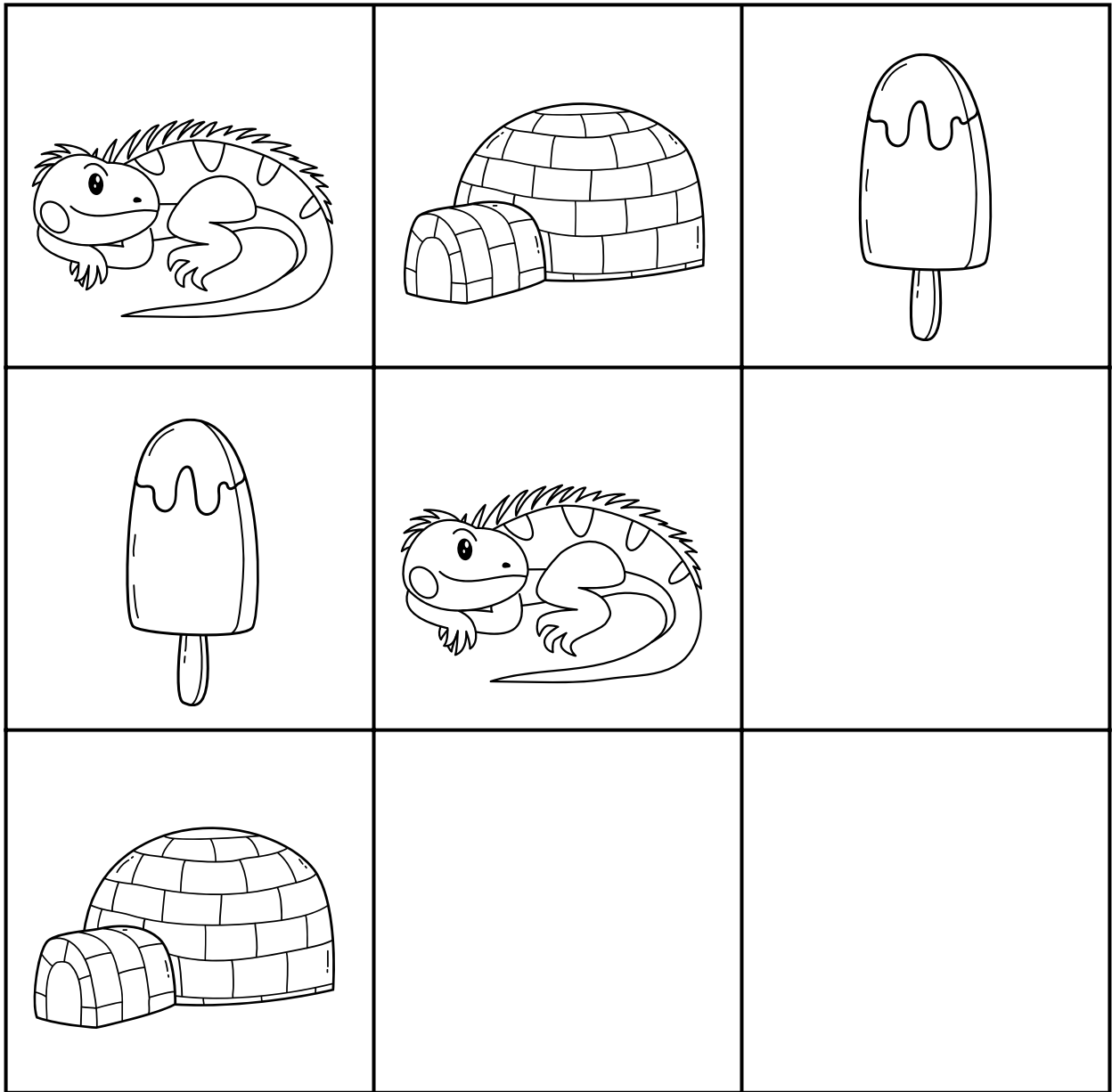

# Alphabet Sudoku Game

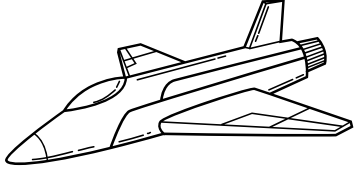

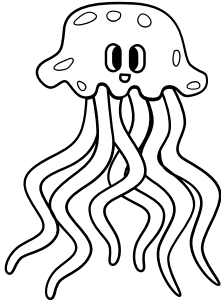
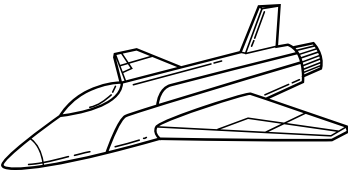
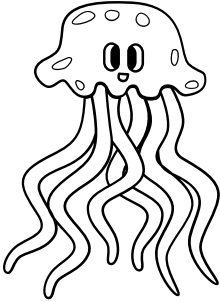
# Alphabet Sudoku Game

		
		
		

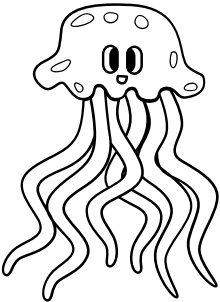
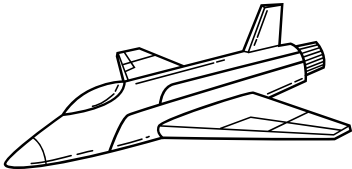

-----

J 	J 	J 
--	--	--

# Alphabet Sudoku Game

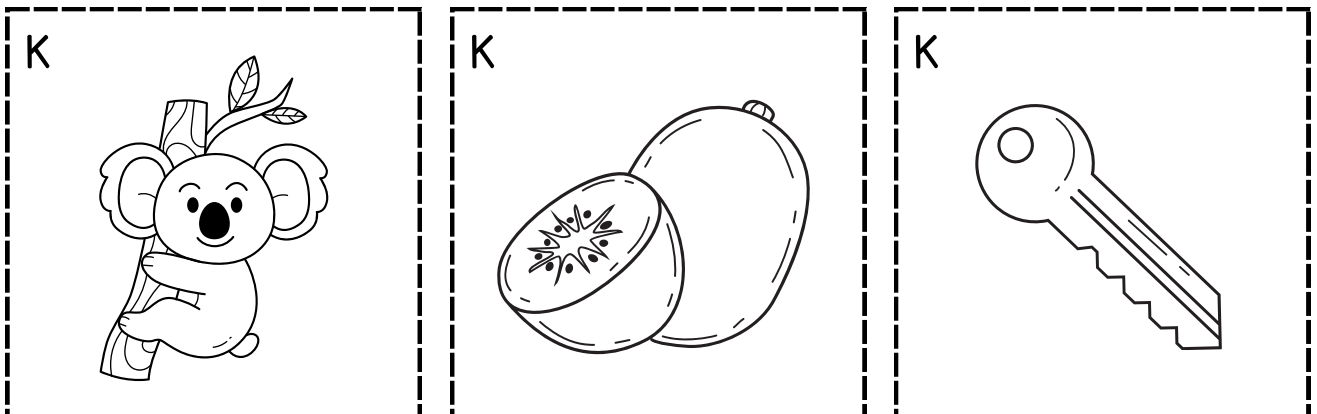
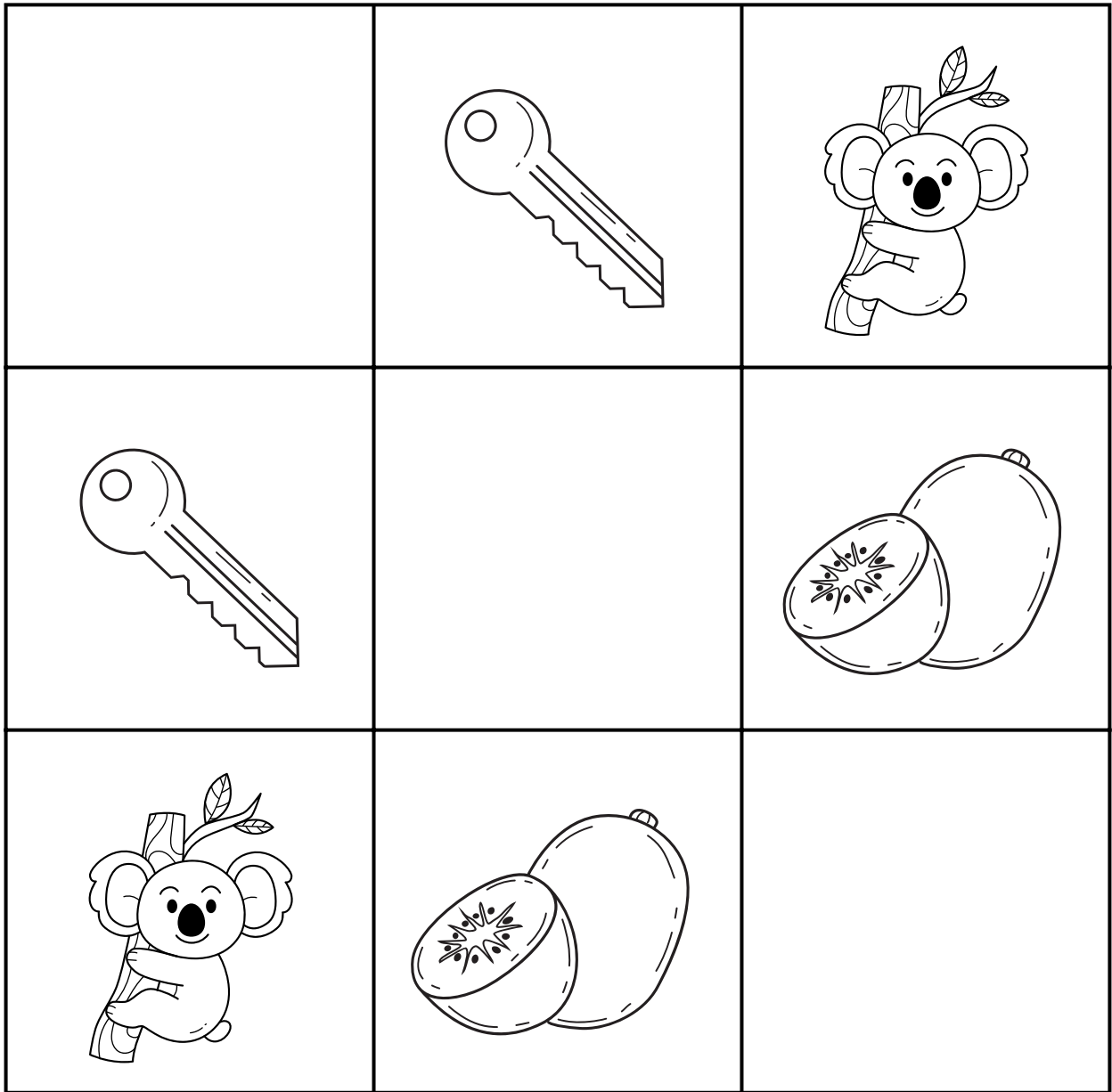



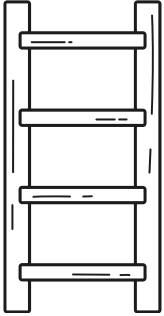
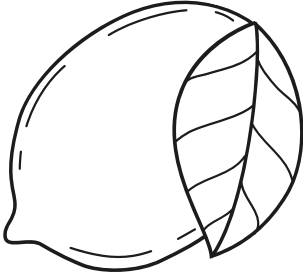
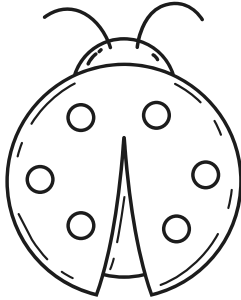
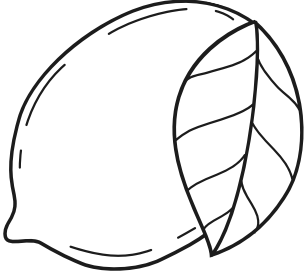
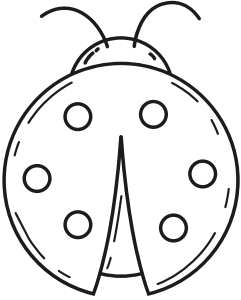
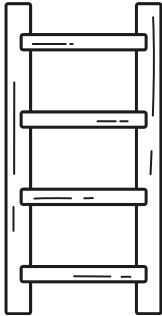

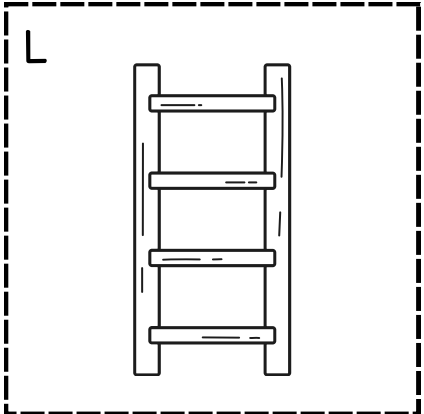
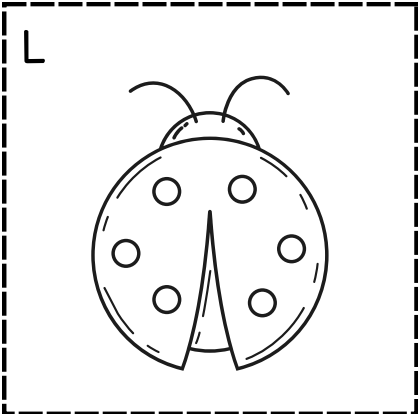
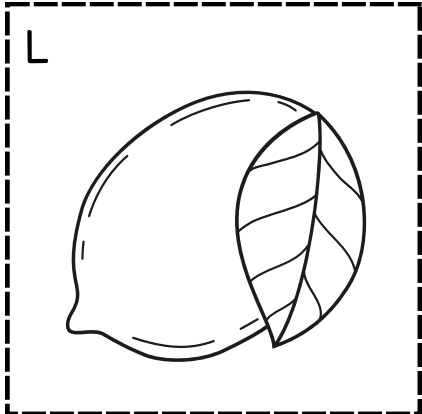
# Alphabet Sudoku Game

		
		
		

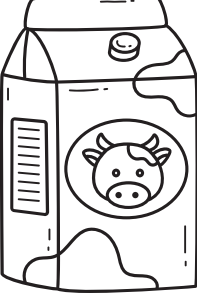
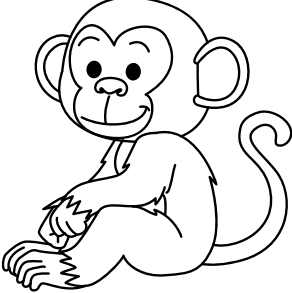

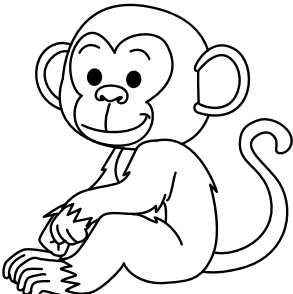
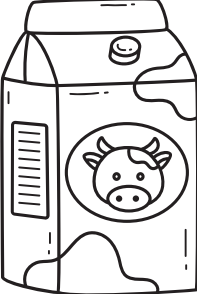
# Alphabet Sudoku Game

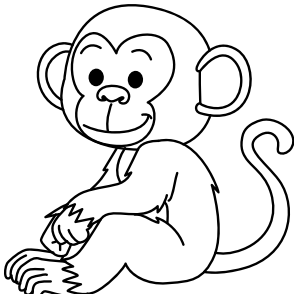

M 

M 

M 

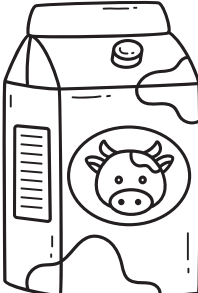
# Alphabet Sudoku Game

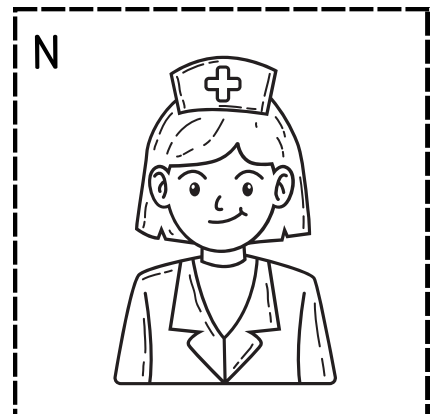
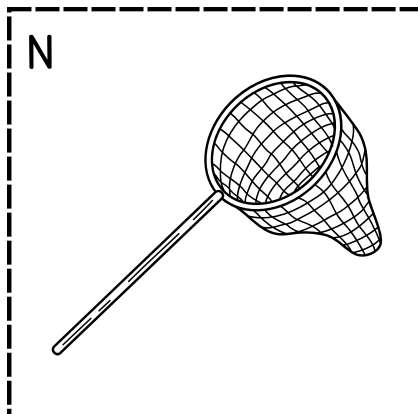
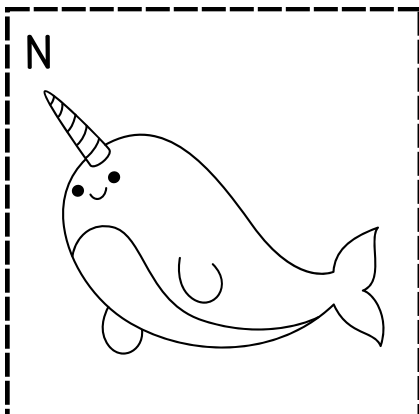
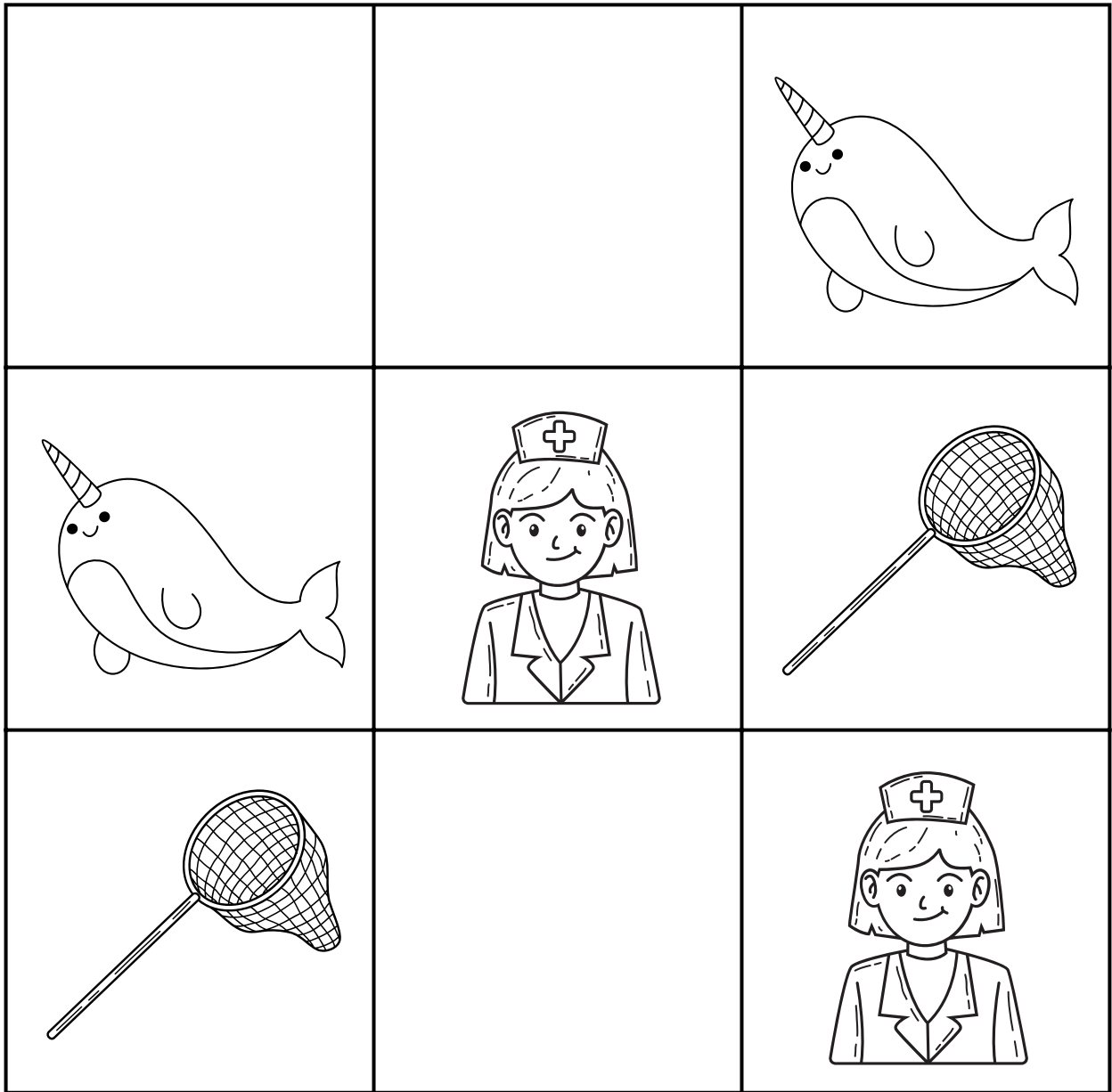

# Alphabet Sudoku Game

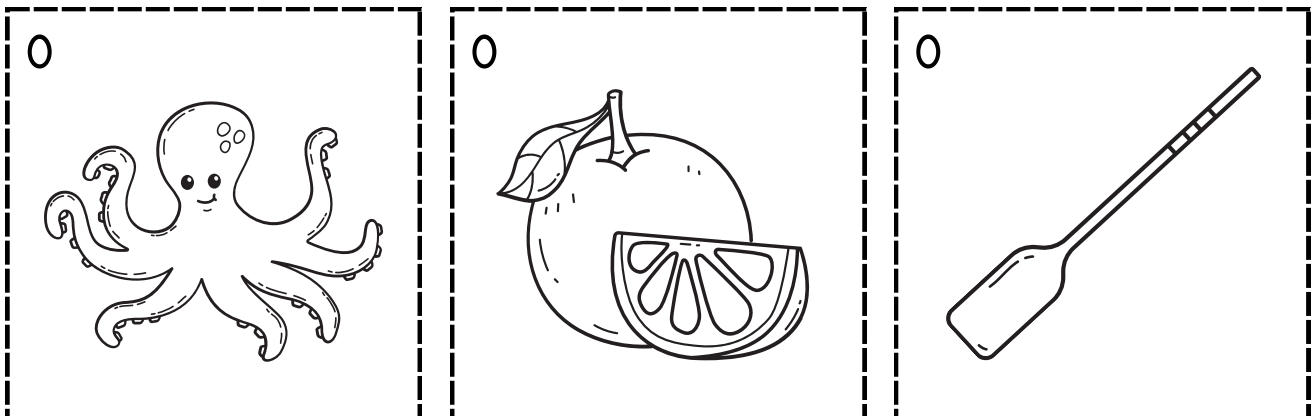
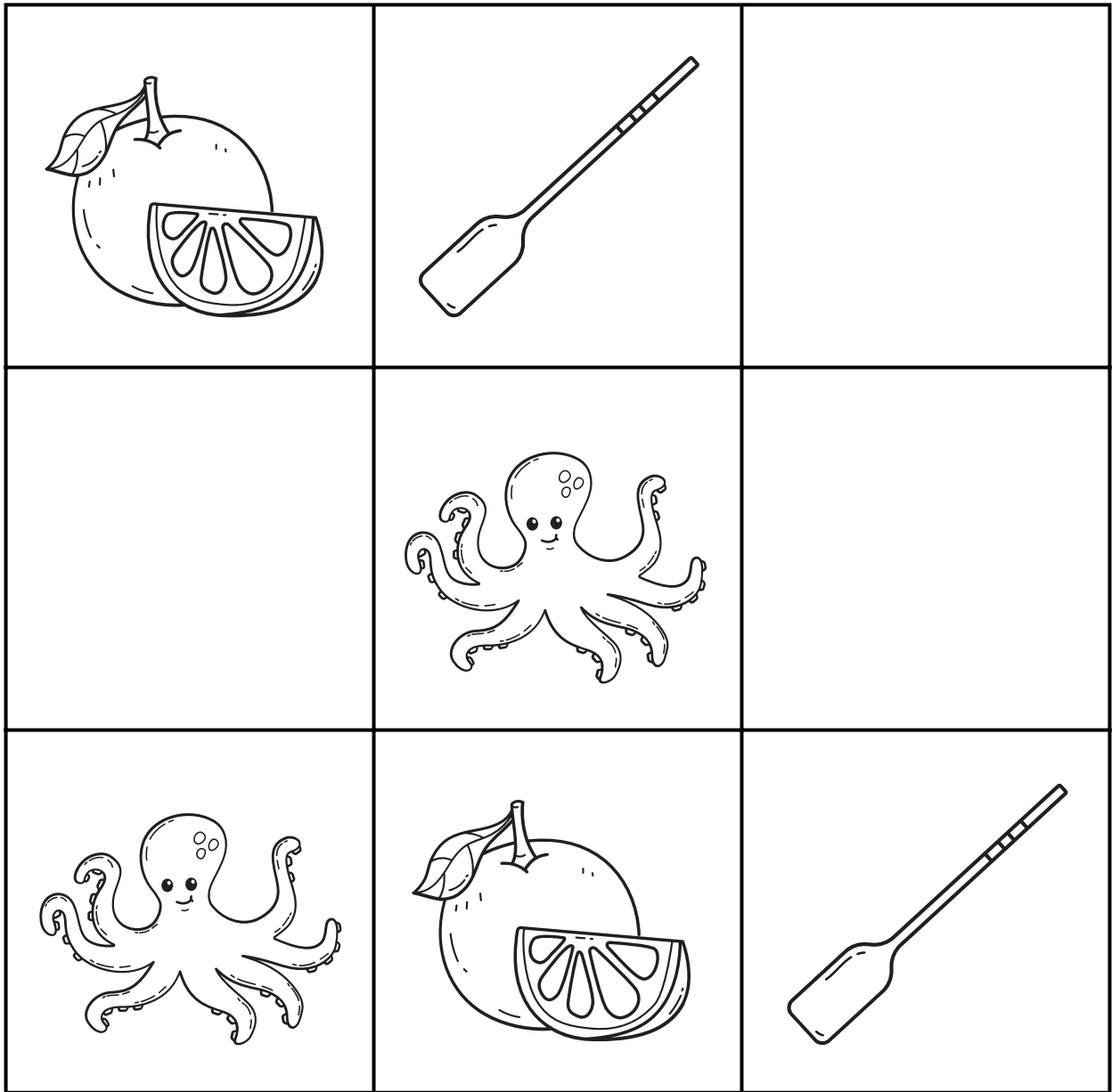

# Alphabet Sudoku Game

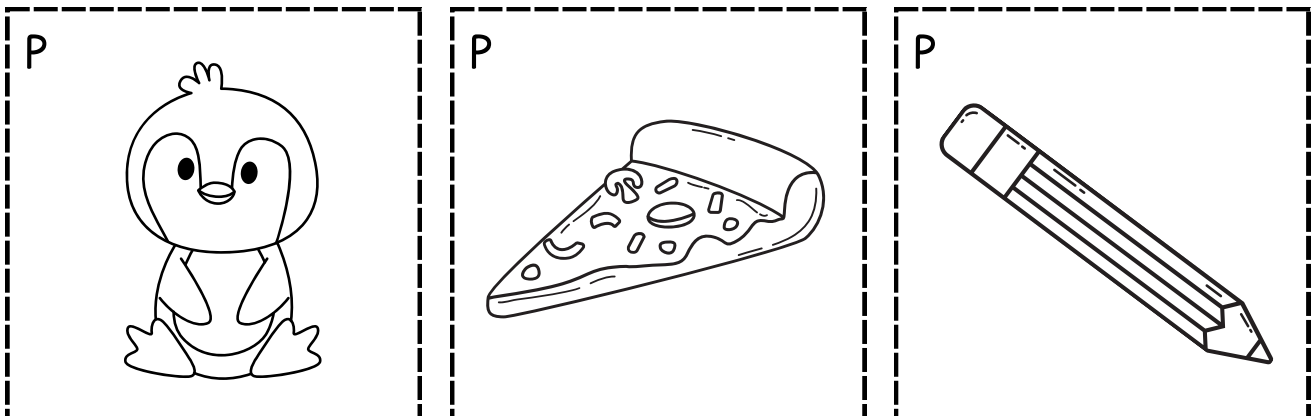
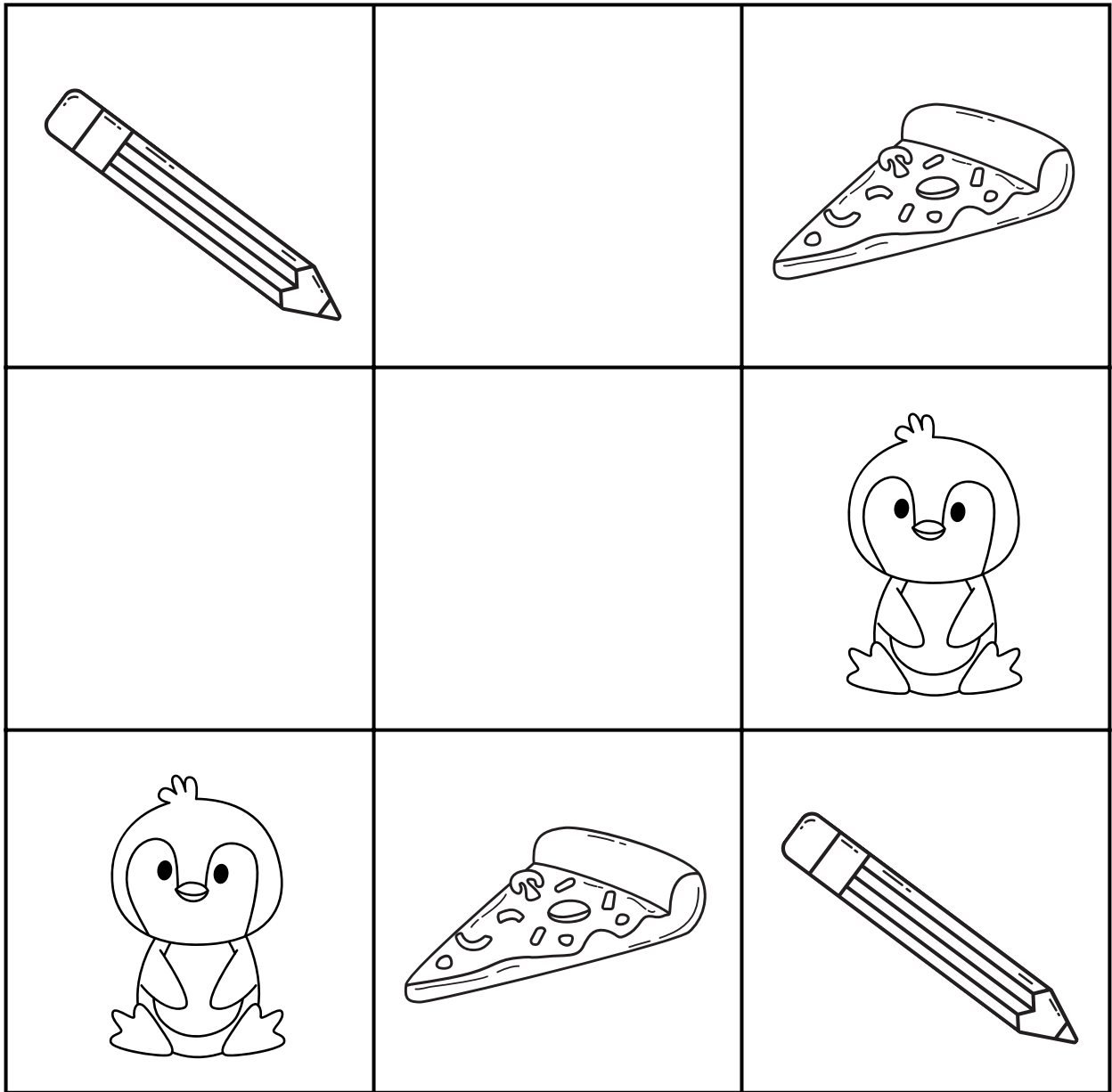

# Alphabet Sudoku Game

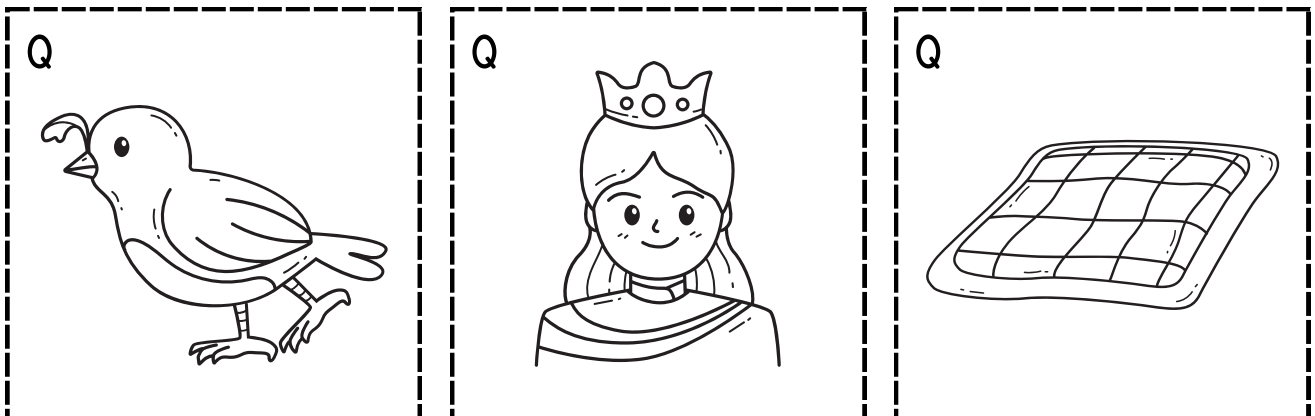
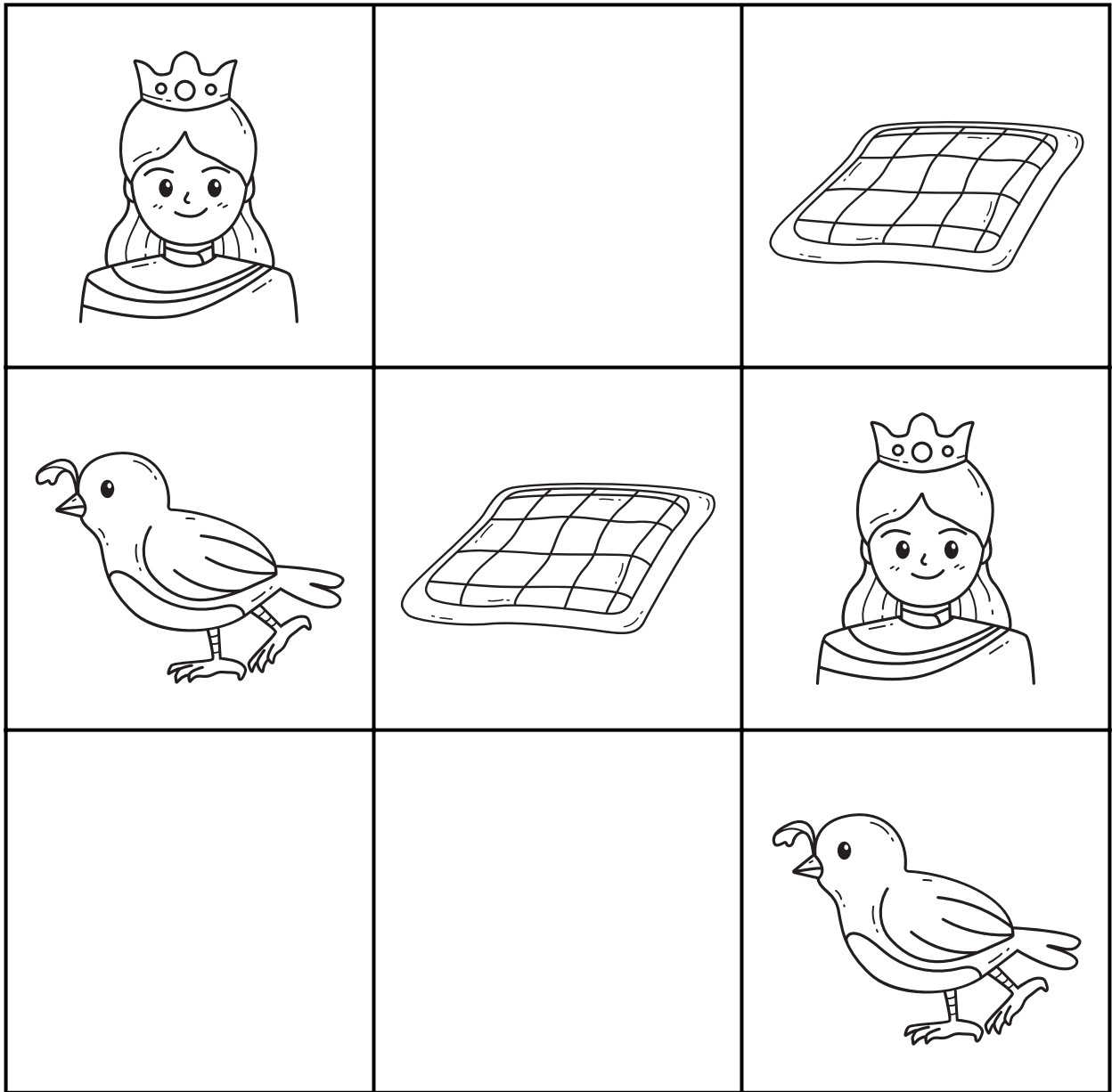

# Alphabet Sudoku Game

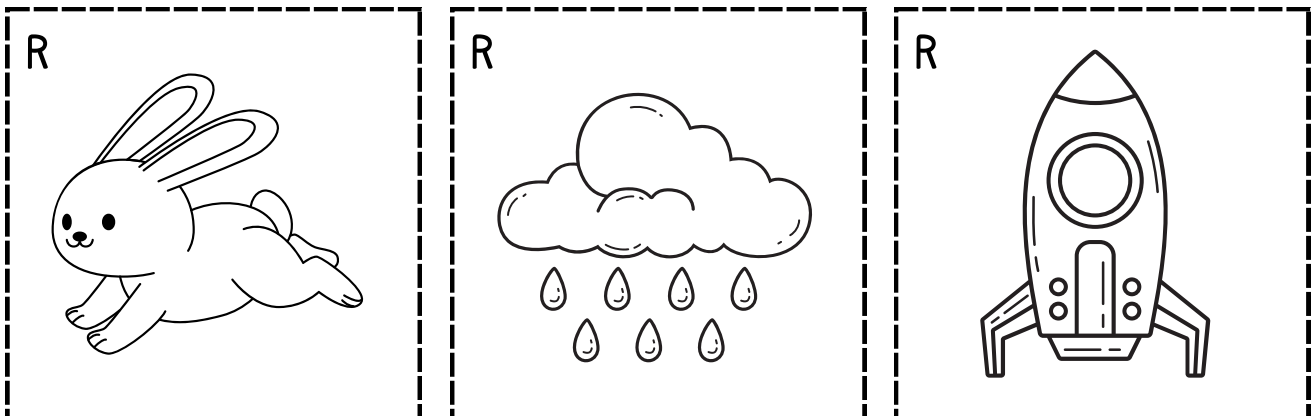
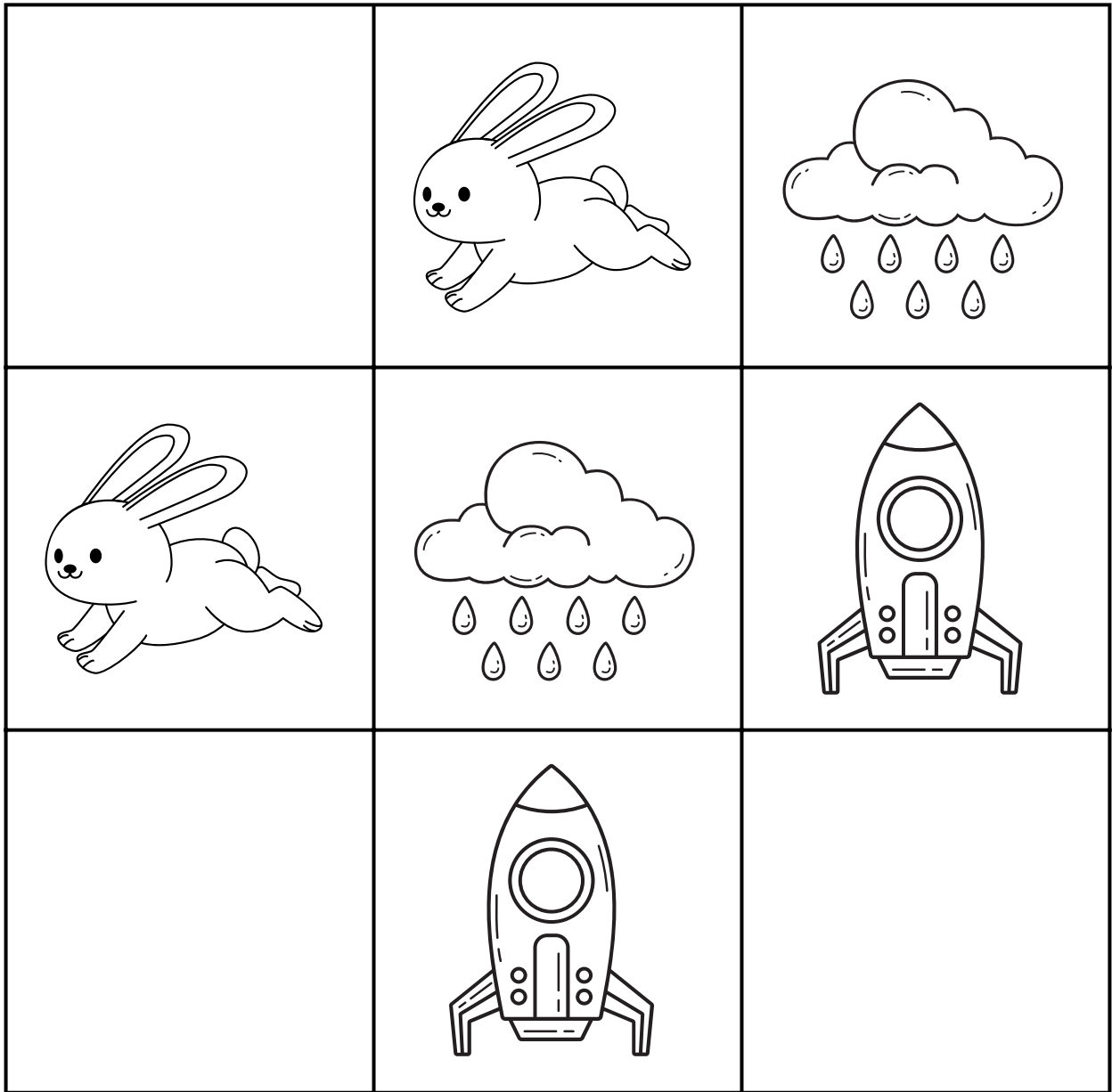

# Alphabet Sudoku Game

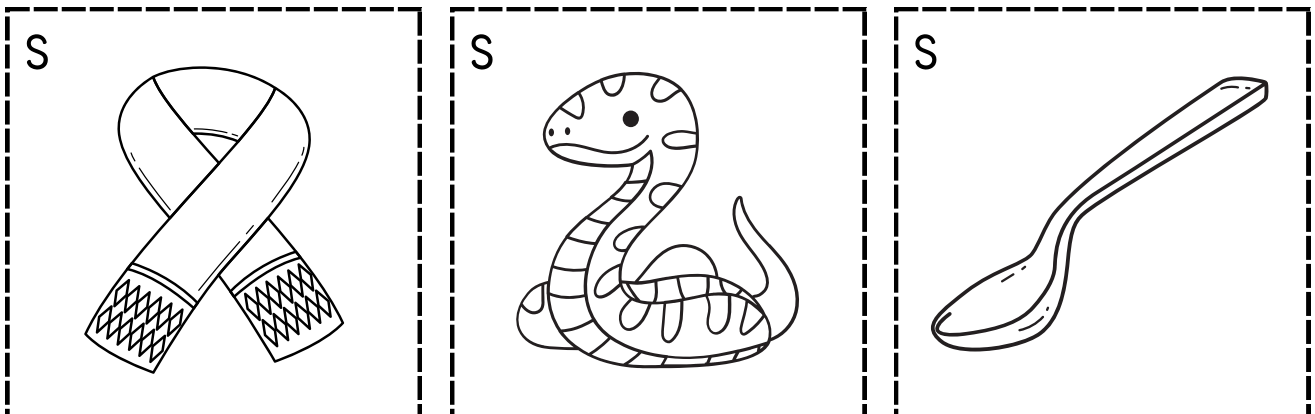
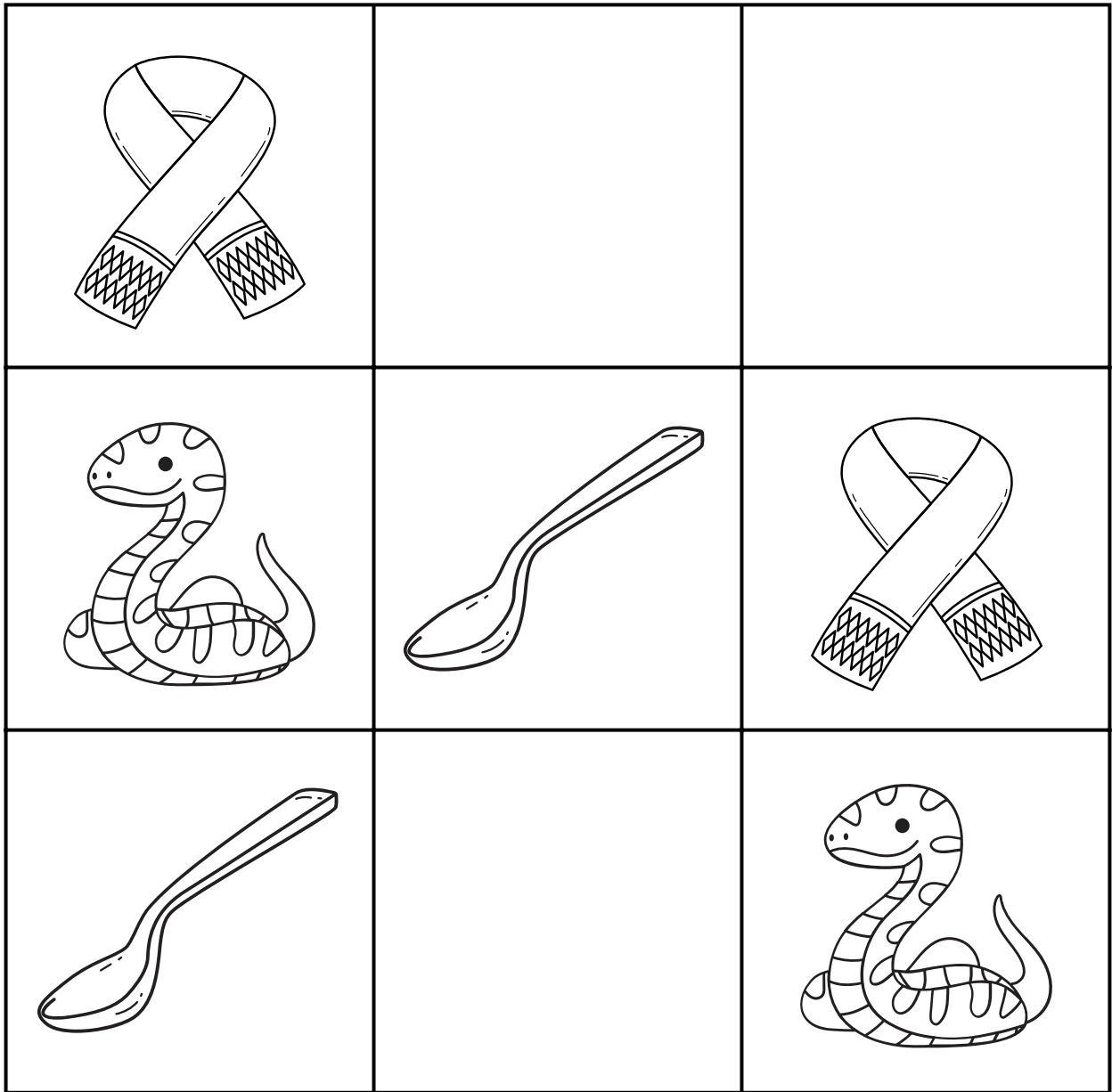

# Alphabet Sudoku Game

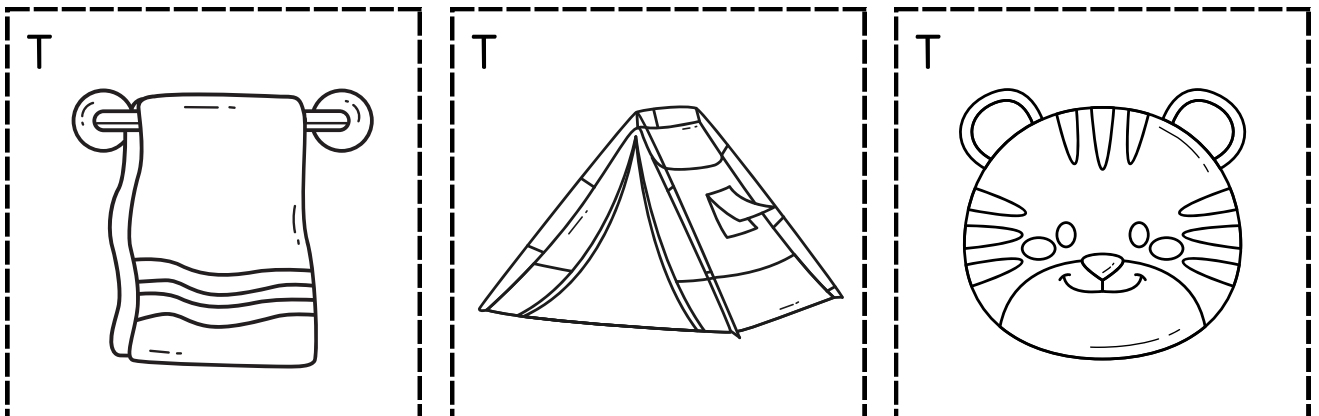
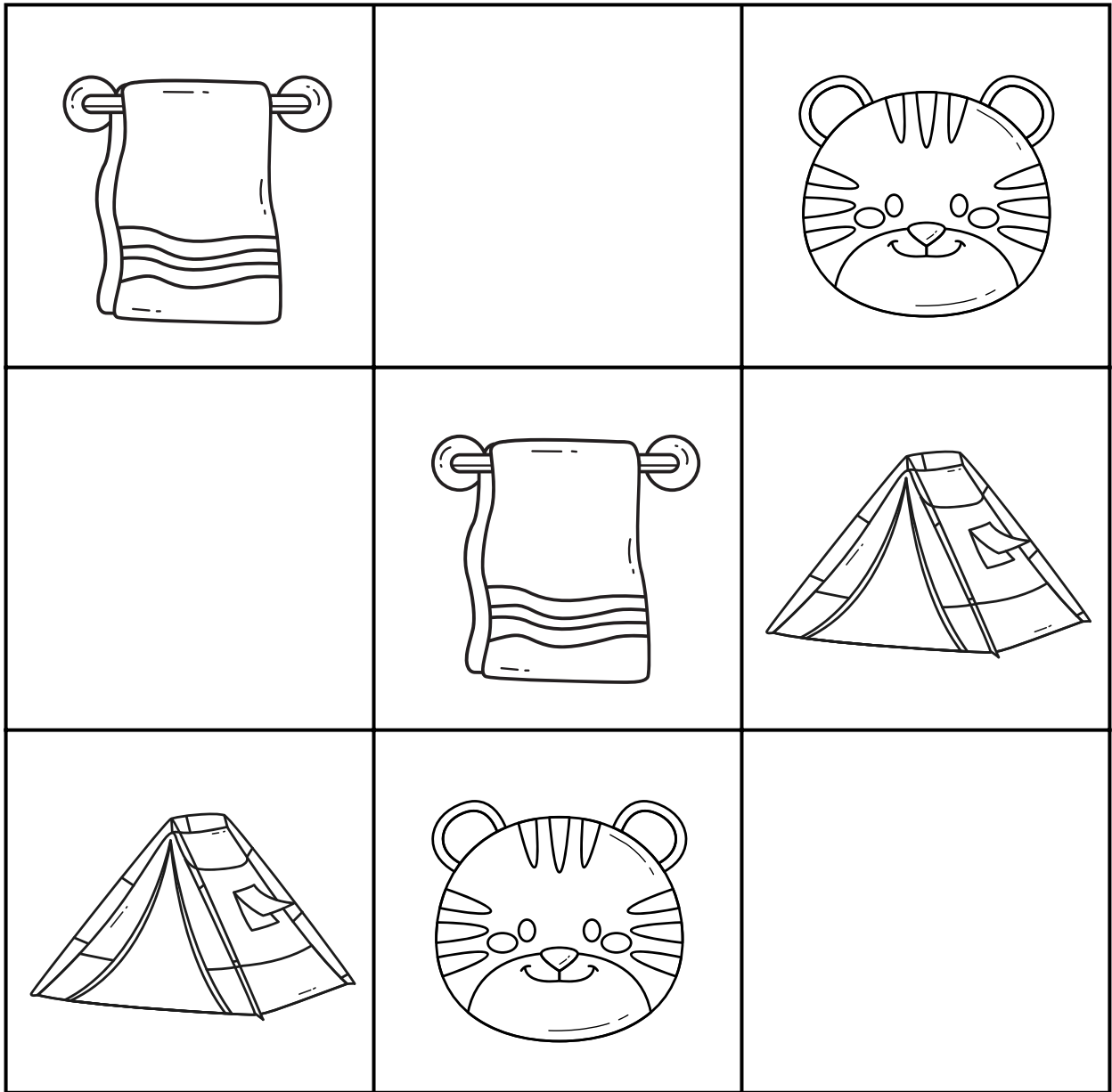

# Alphabet Sudoku Game

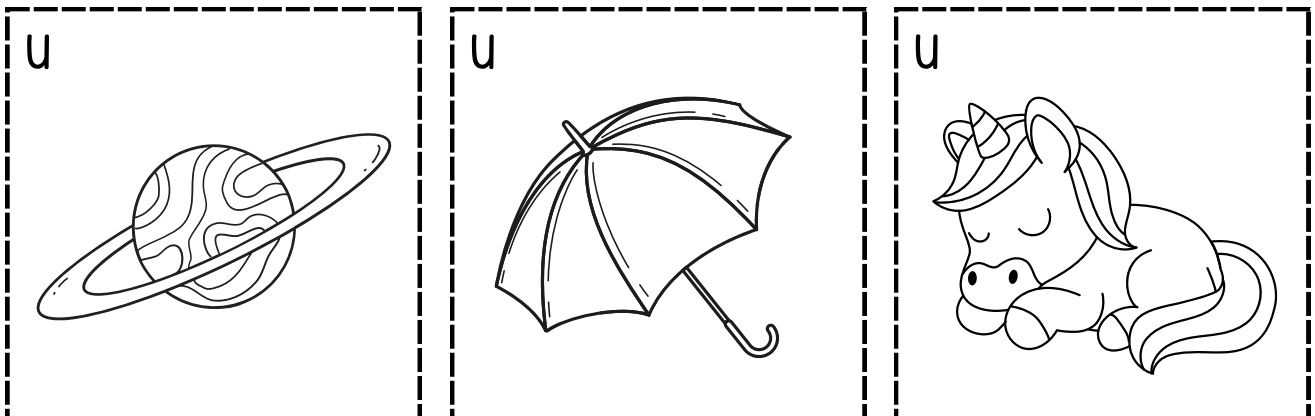
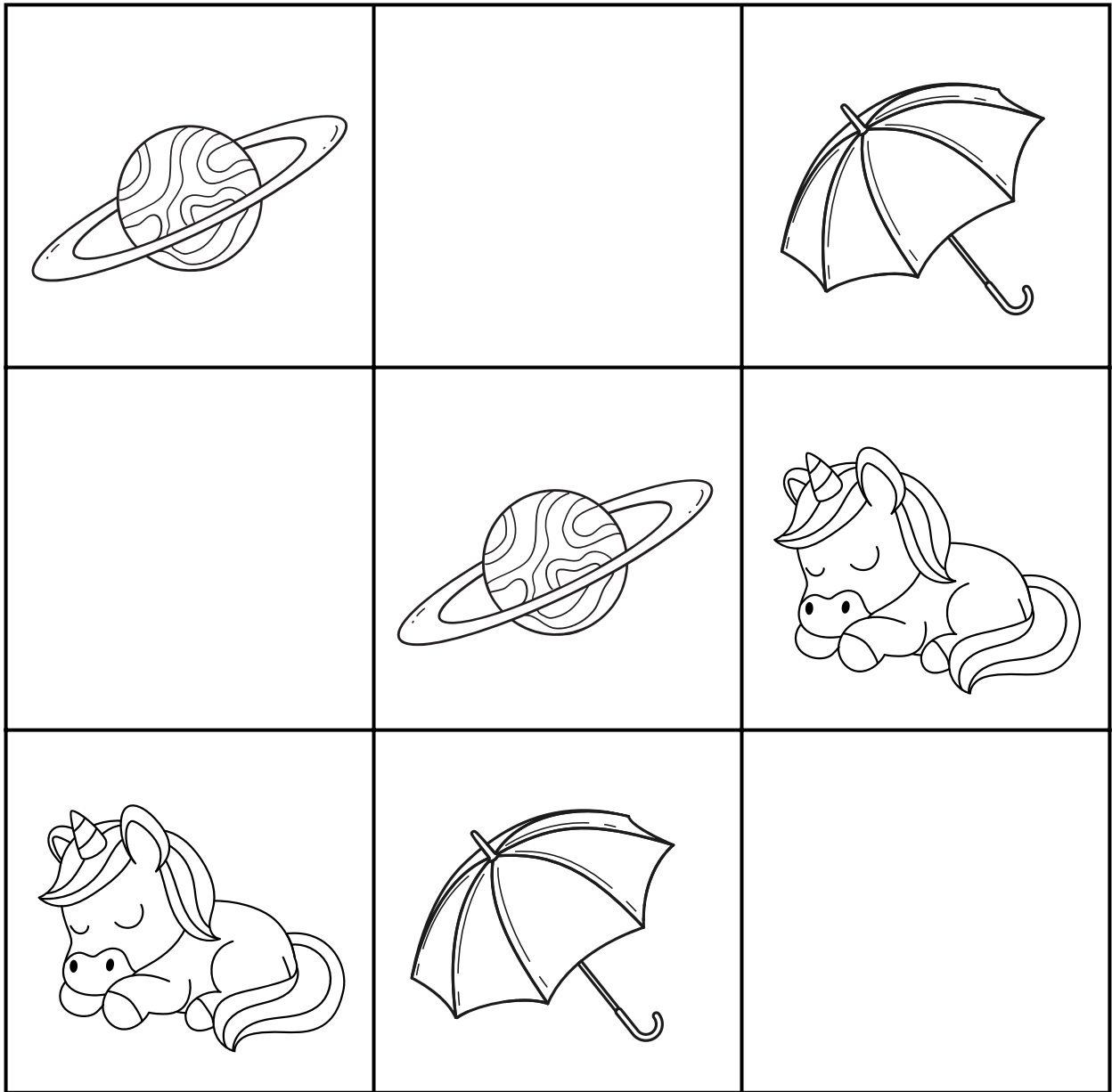

# Alphabet Sudoku Game

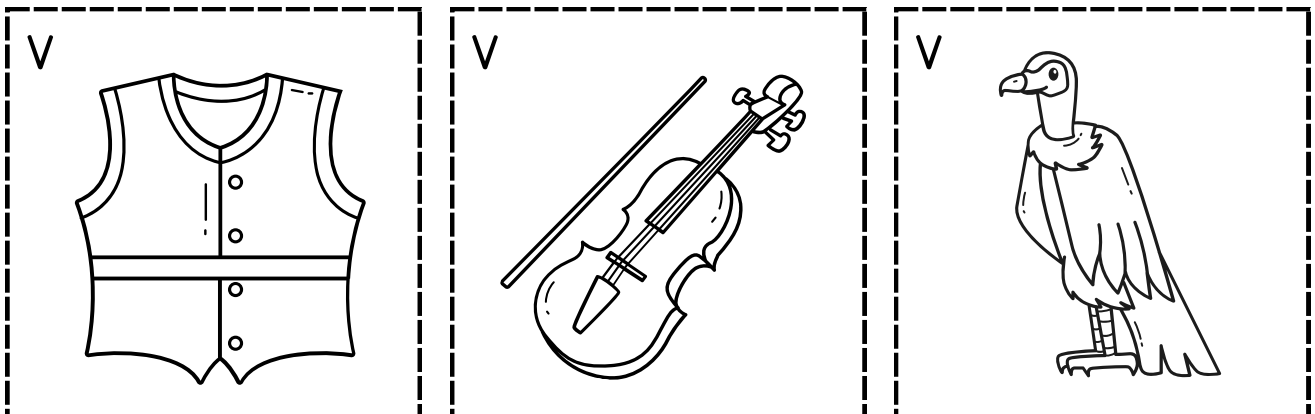
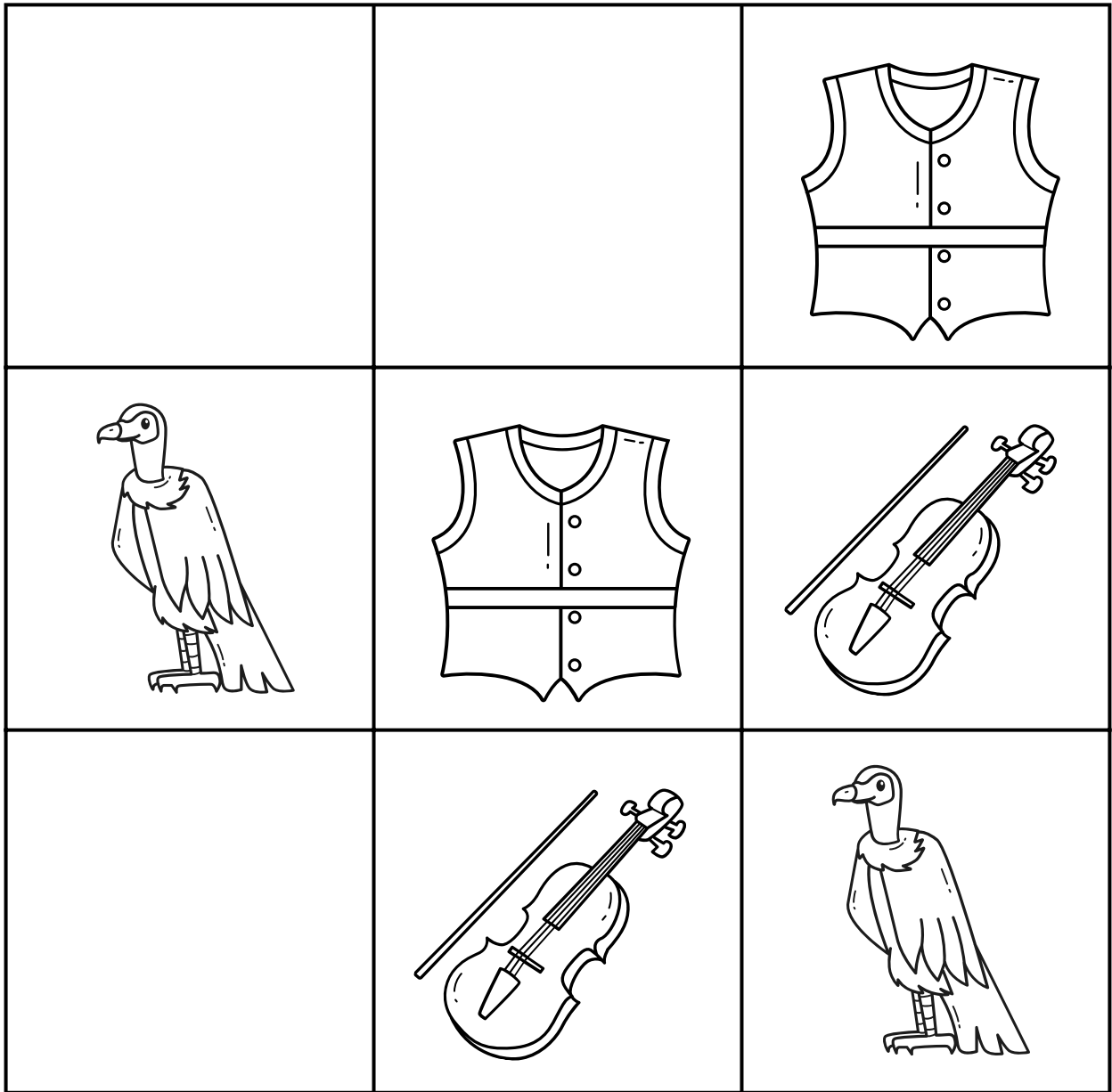

# Alphabet Sudoku Game

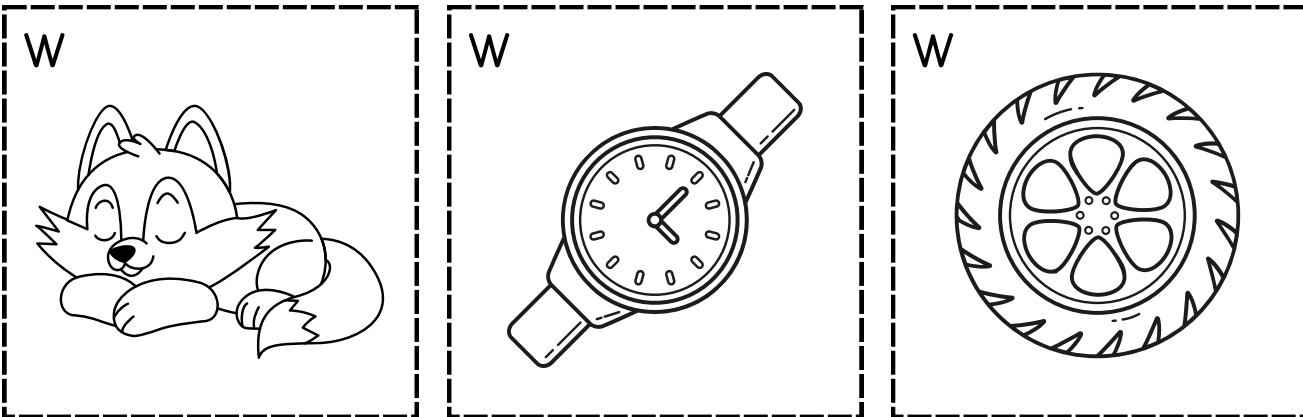
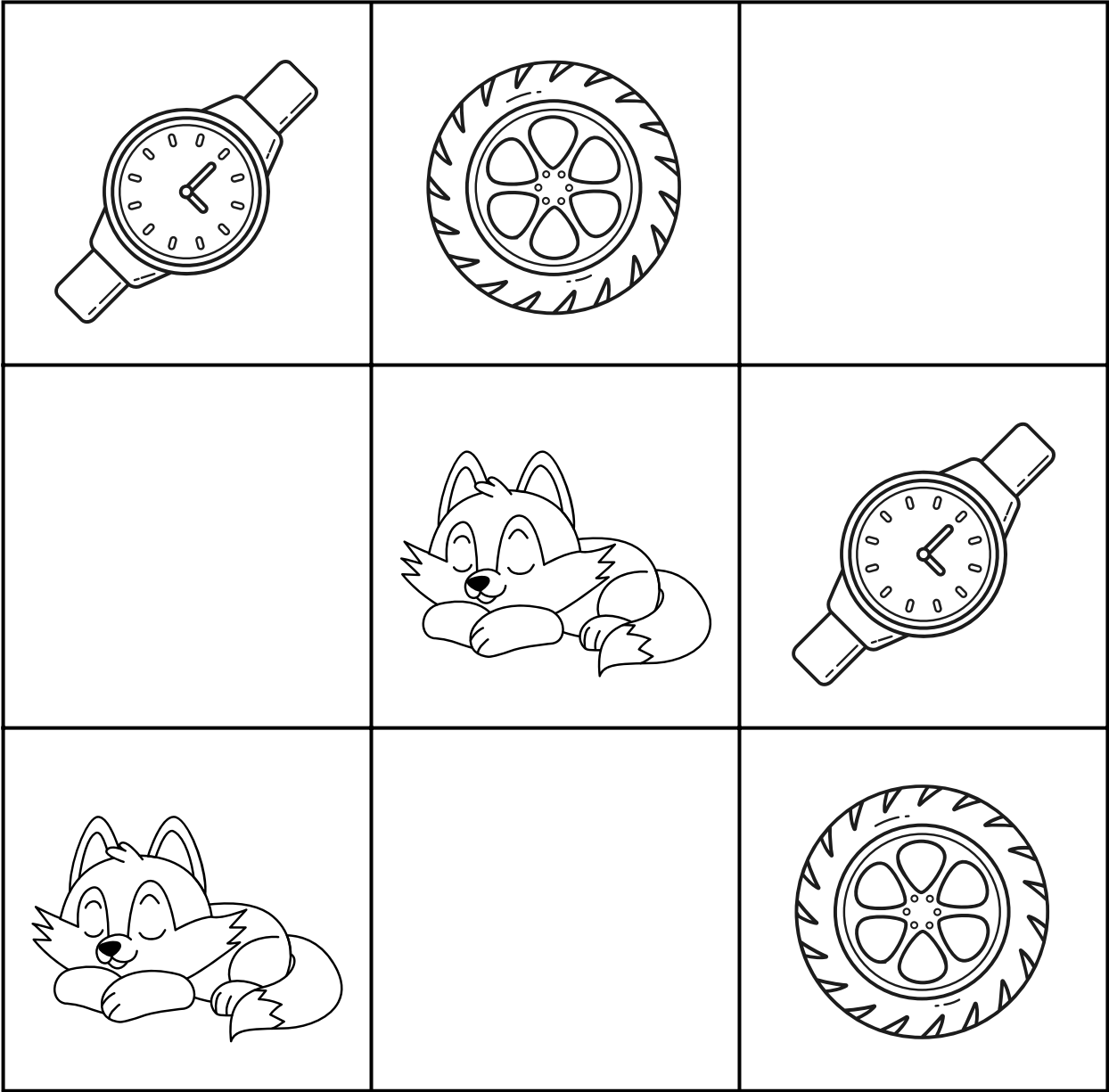

# Alphabet Sudoku Game

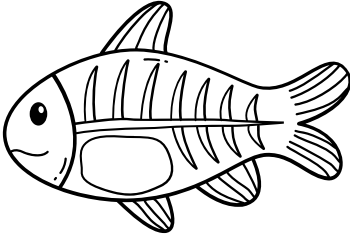
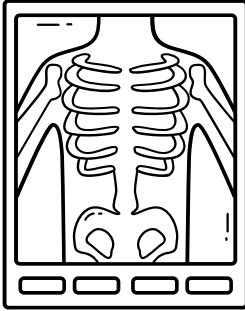
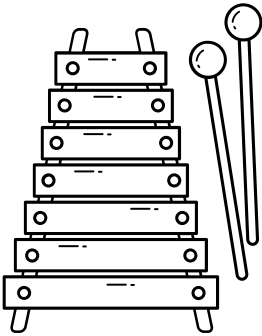
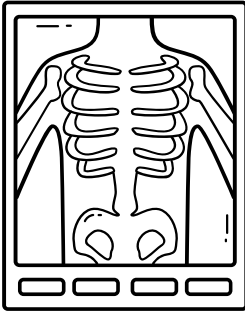
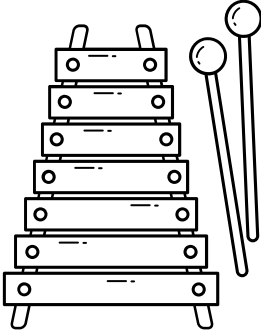
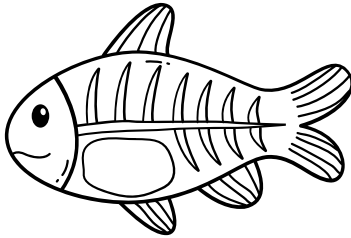

X 	X 	X 
--	--	--

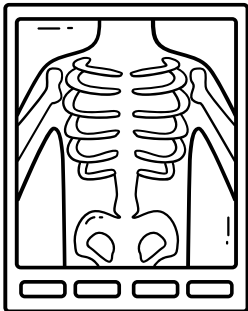
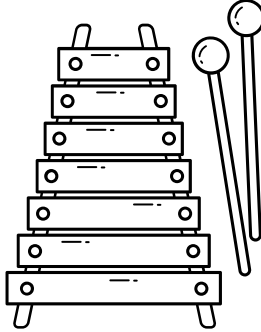
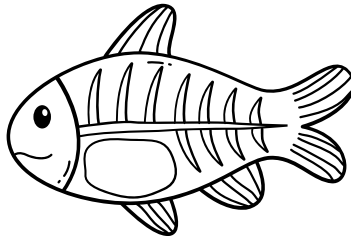
# Alphabet Sudoku Game

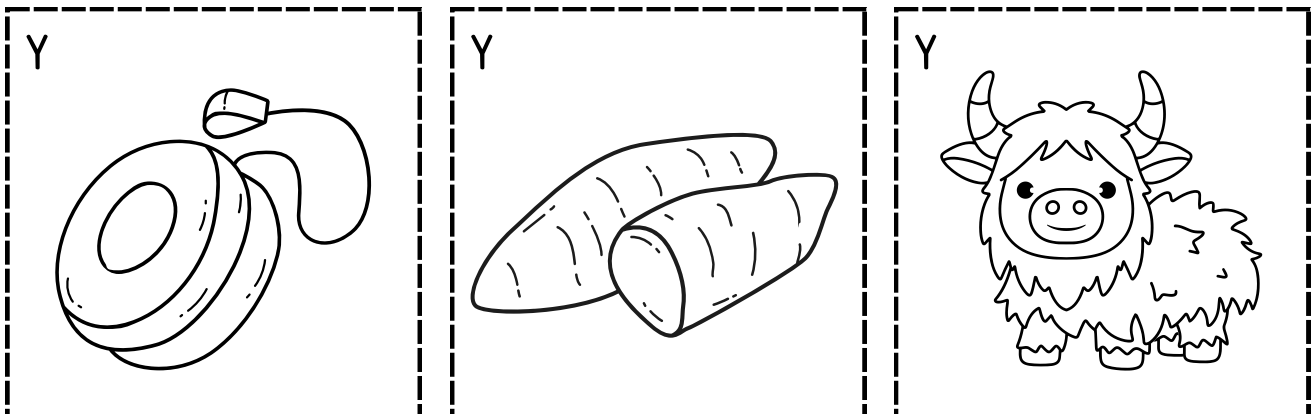
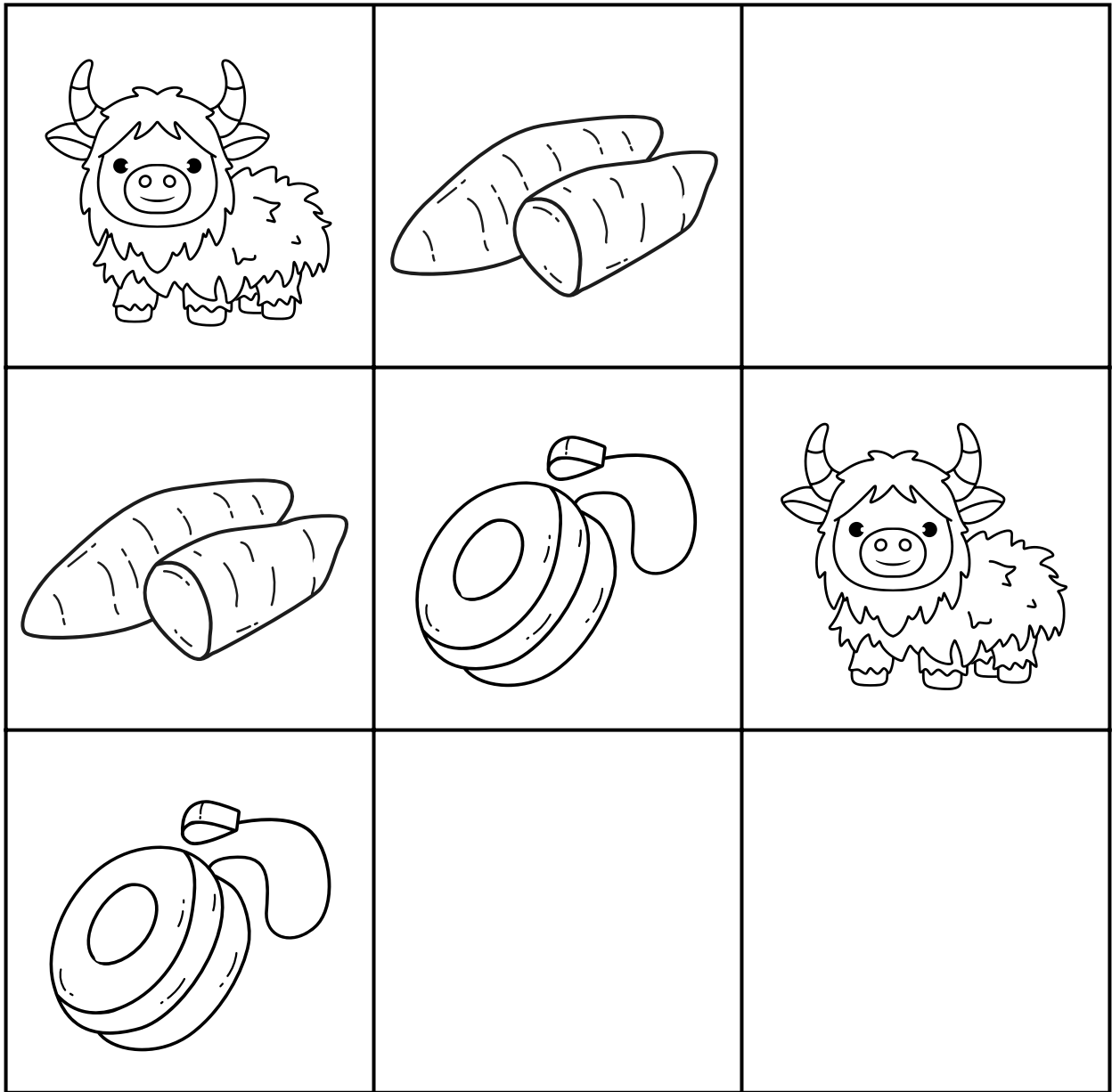

# Alphabet Sudoku Game

