

k

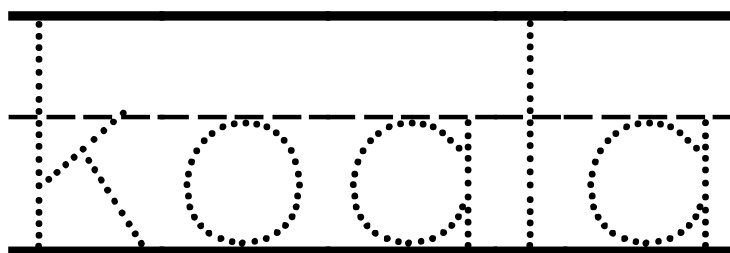

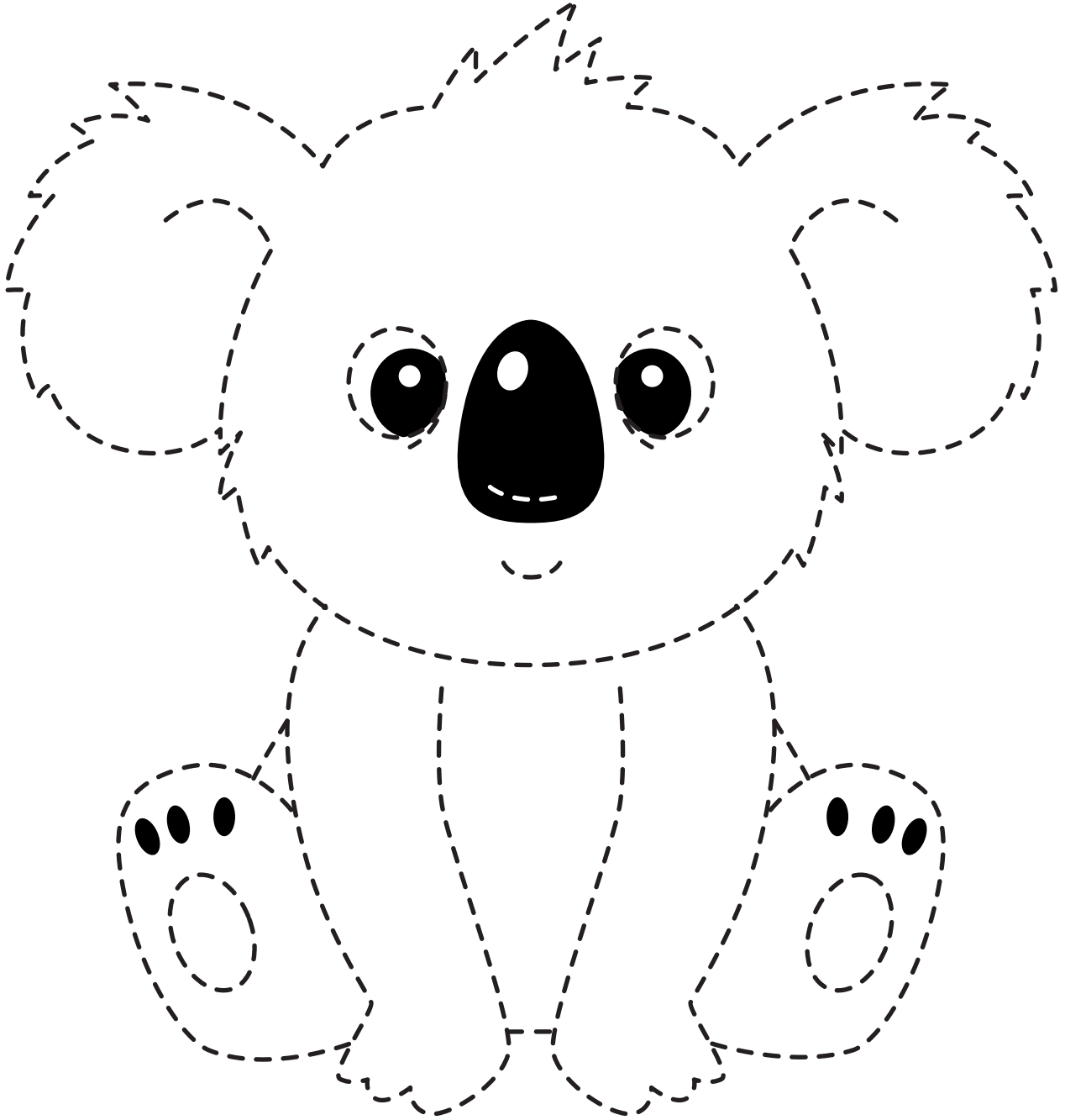

K is for Koala

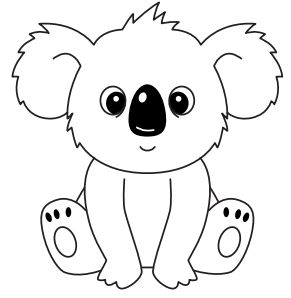
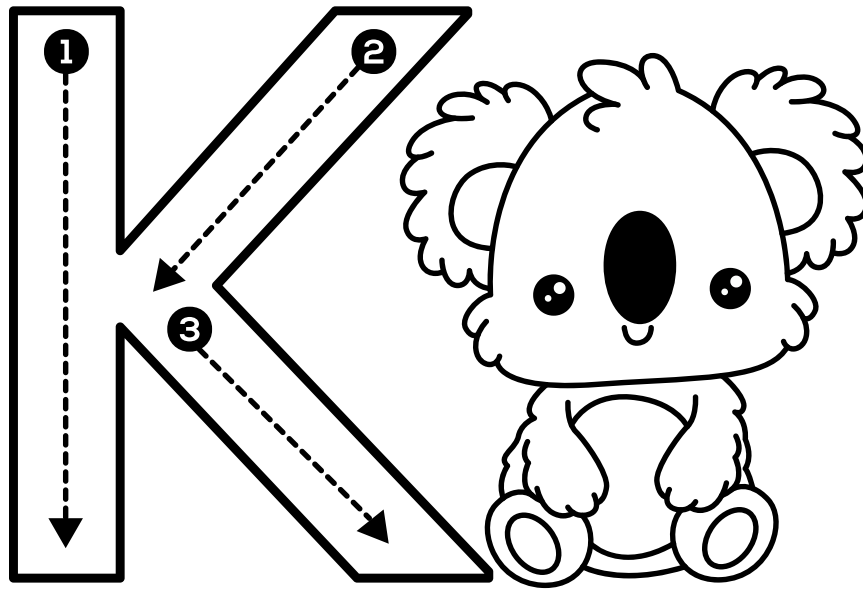
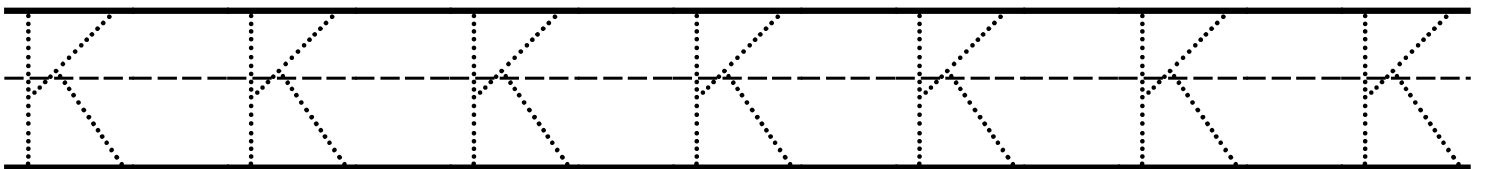
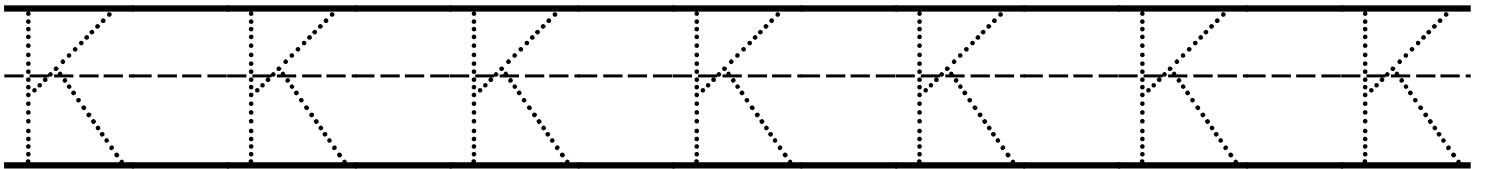
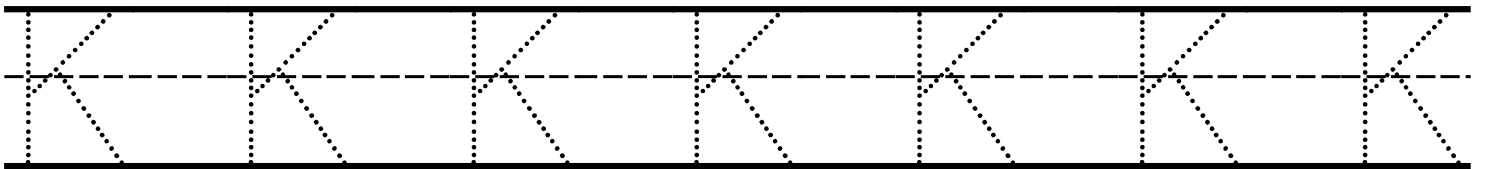
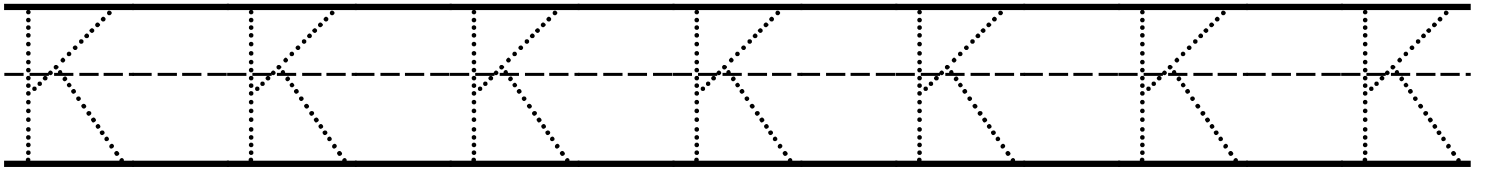

Koala ABC Tracing



Aa

Bb

Cc

Dd

Ee

Ff

Gg

Hh

Ii

Jj

Kk

Ll

Mm

Nn

Oo

Pp

Qq

Rr

Ss

Tt

Uu

Vv

Ww

Xx

Yy

Zz

koala



Four sets of handwriting practice lines. Each set consists of a solid top line, a dashed middle line, and a solid bottom line.

Koala Line Tracing

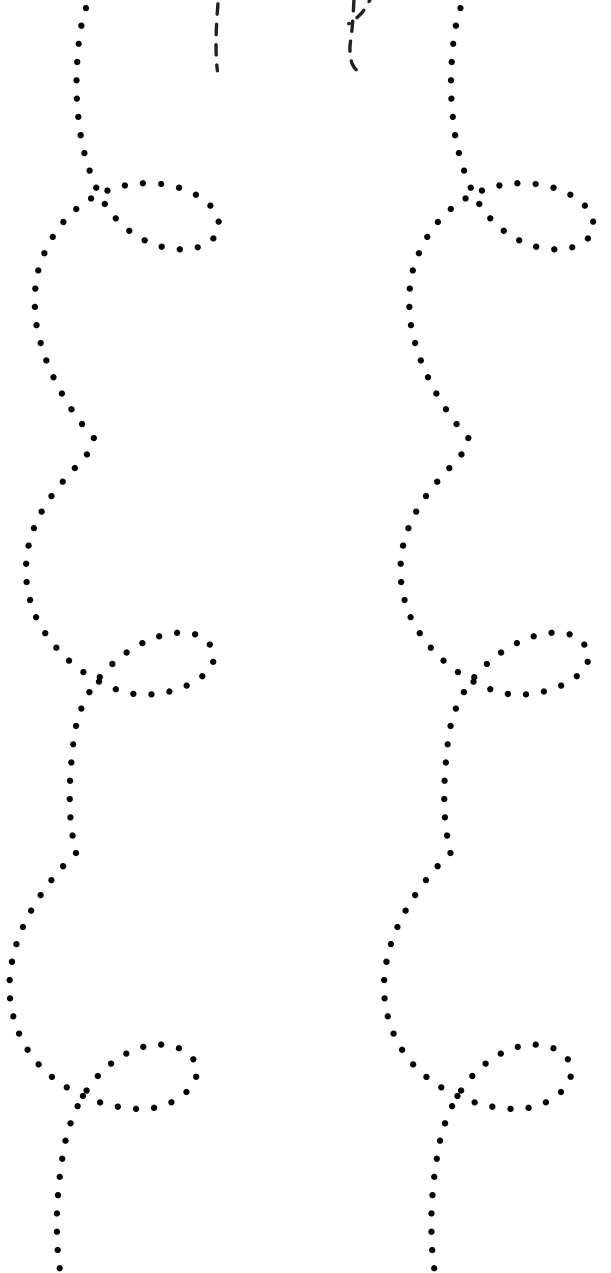
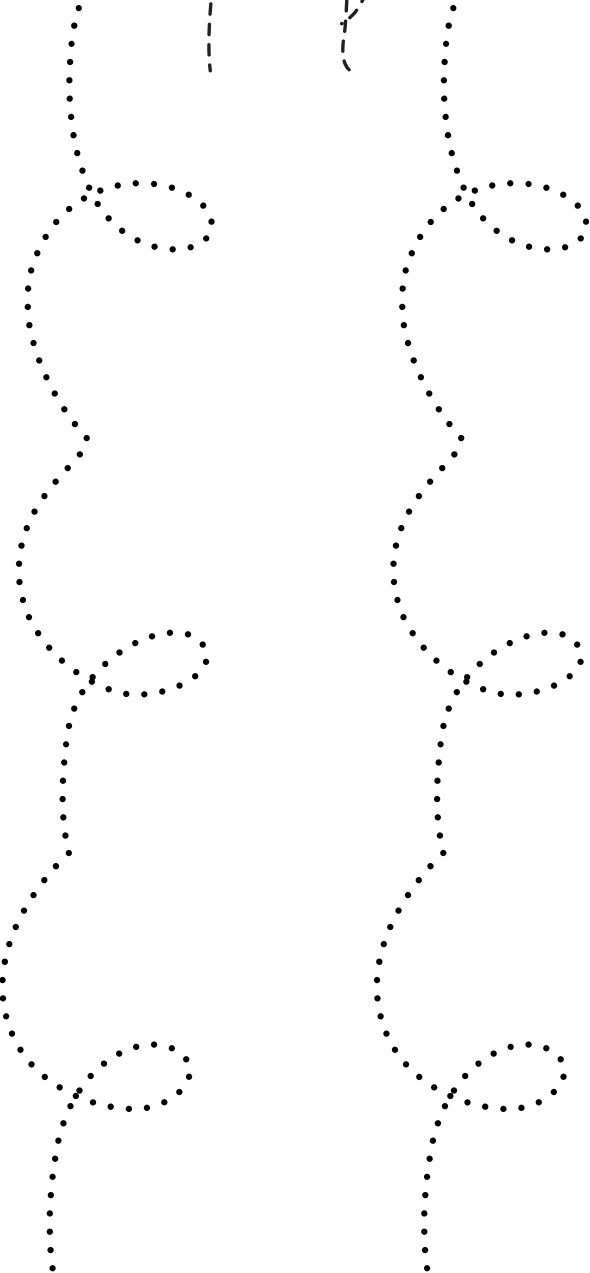
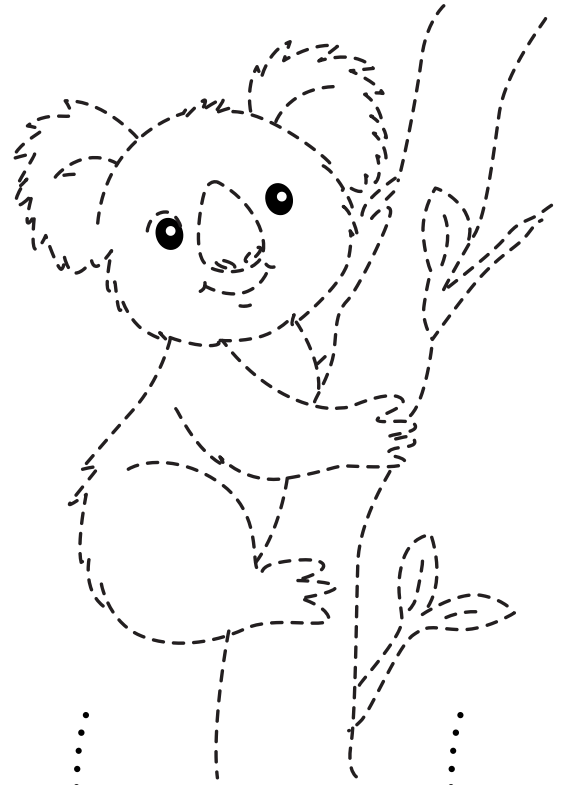
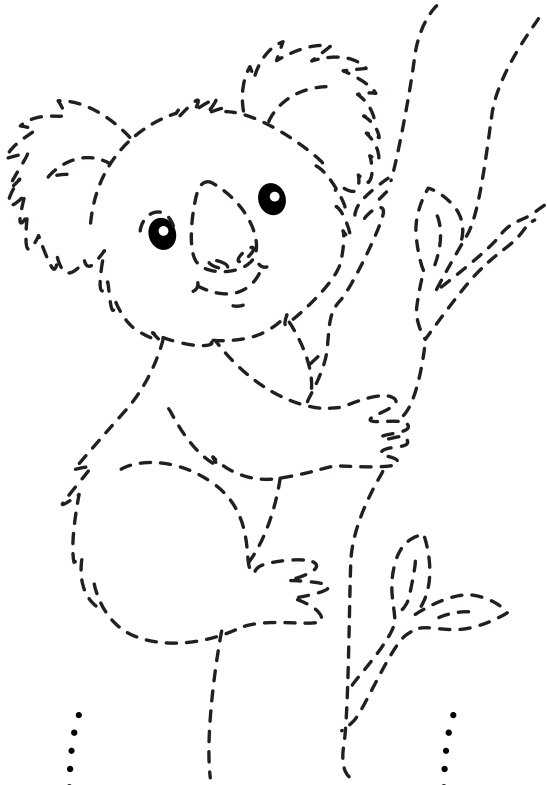

Koala Line Drawing



Koala Line Coloring

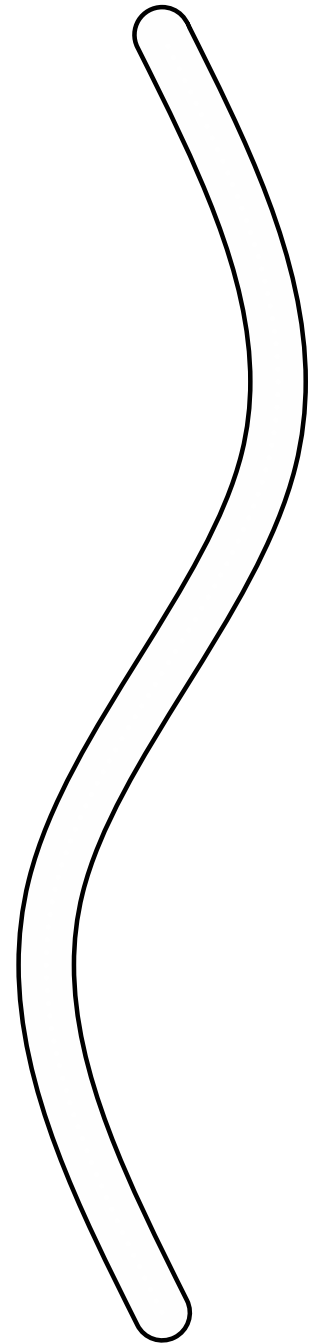
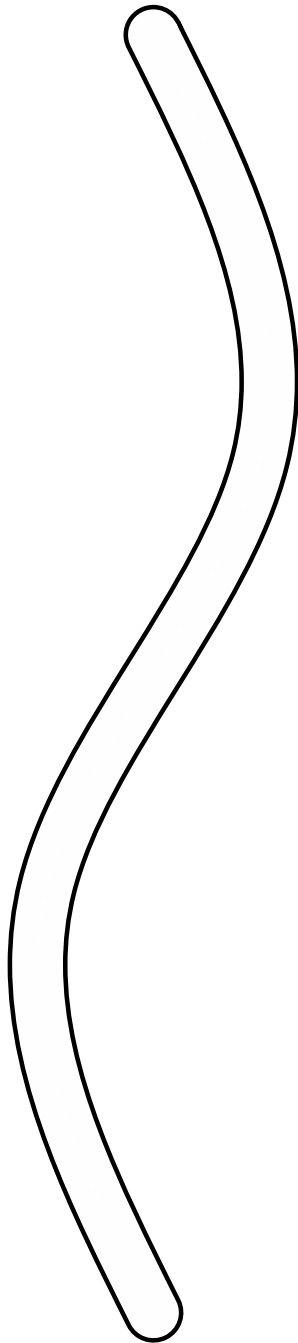
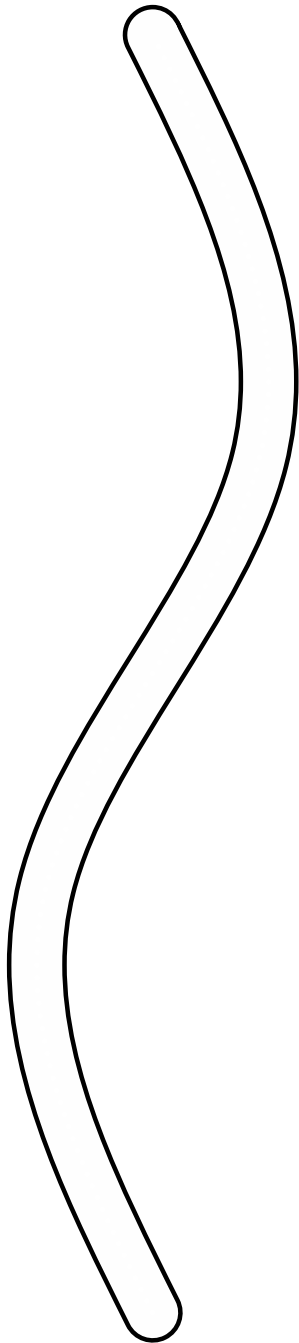
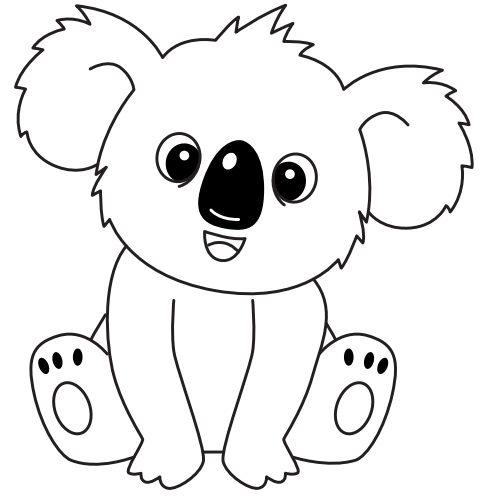
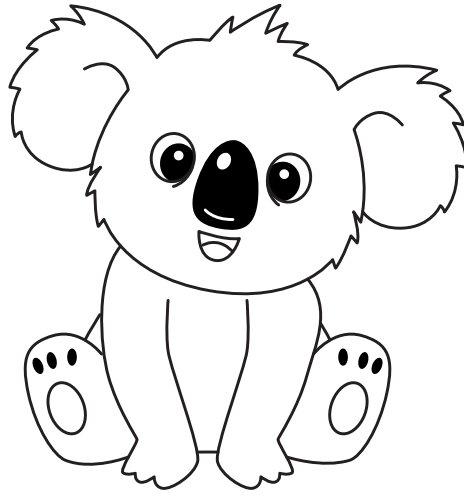
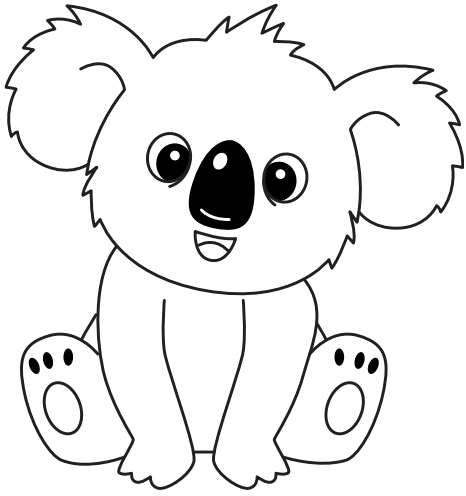

Koala Line Cutting

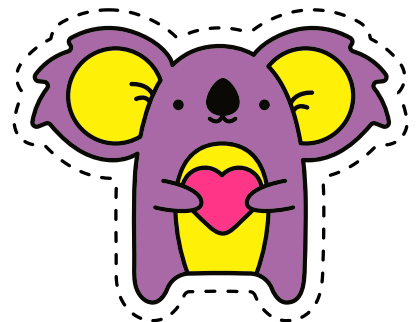
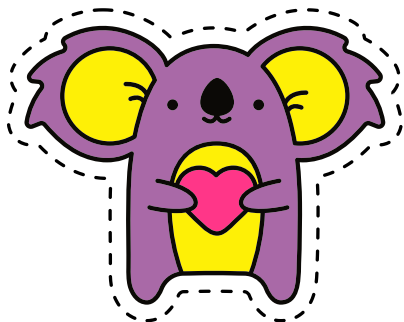
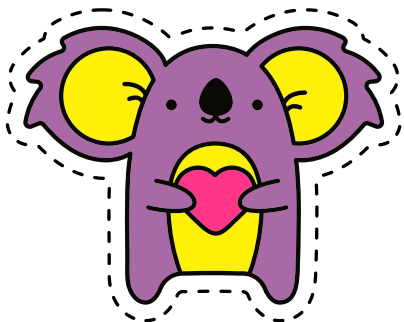
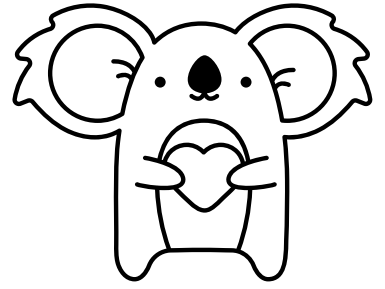
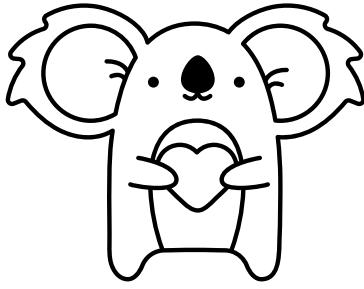
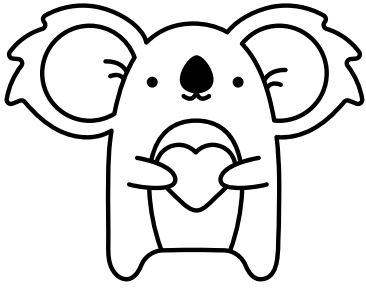

Koala Puzzle

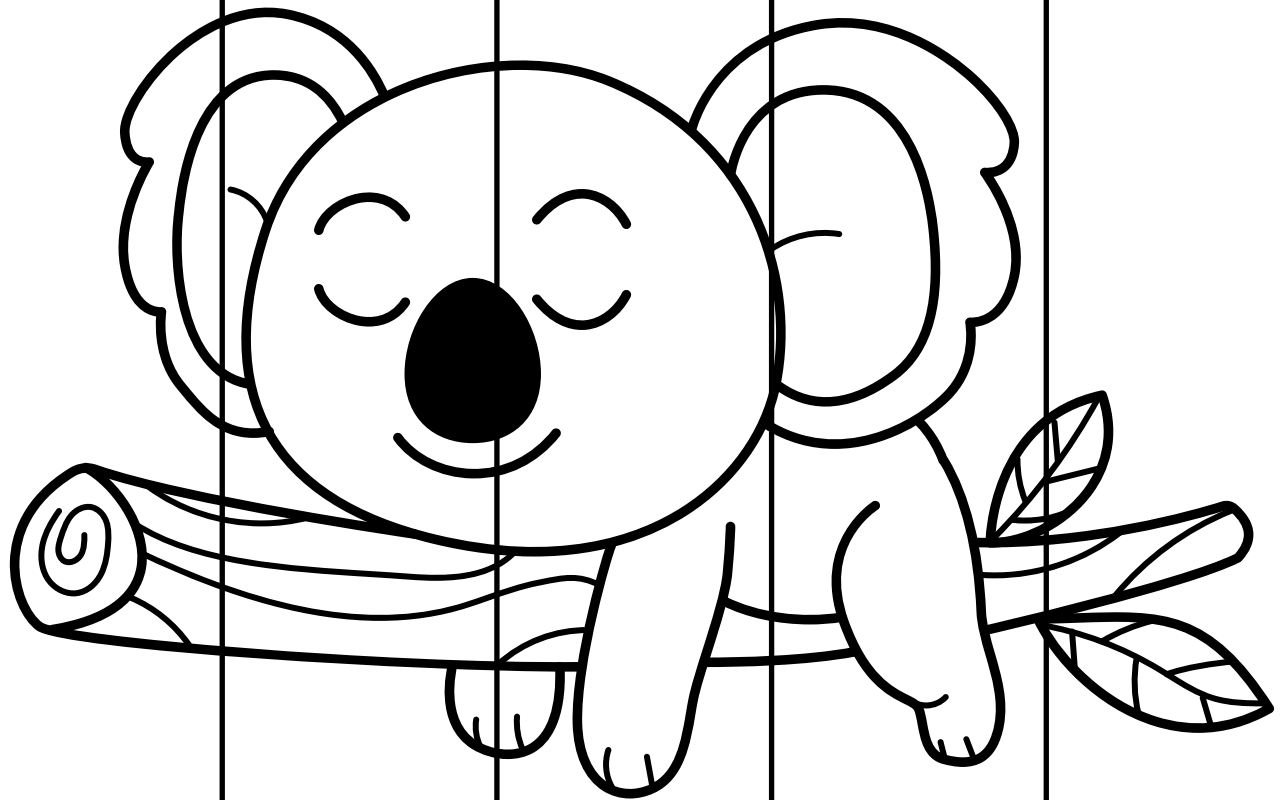

1

2

3

4

5

Koala Puzzle

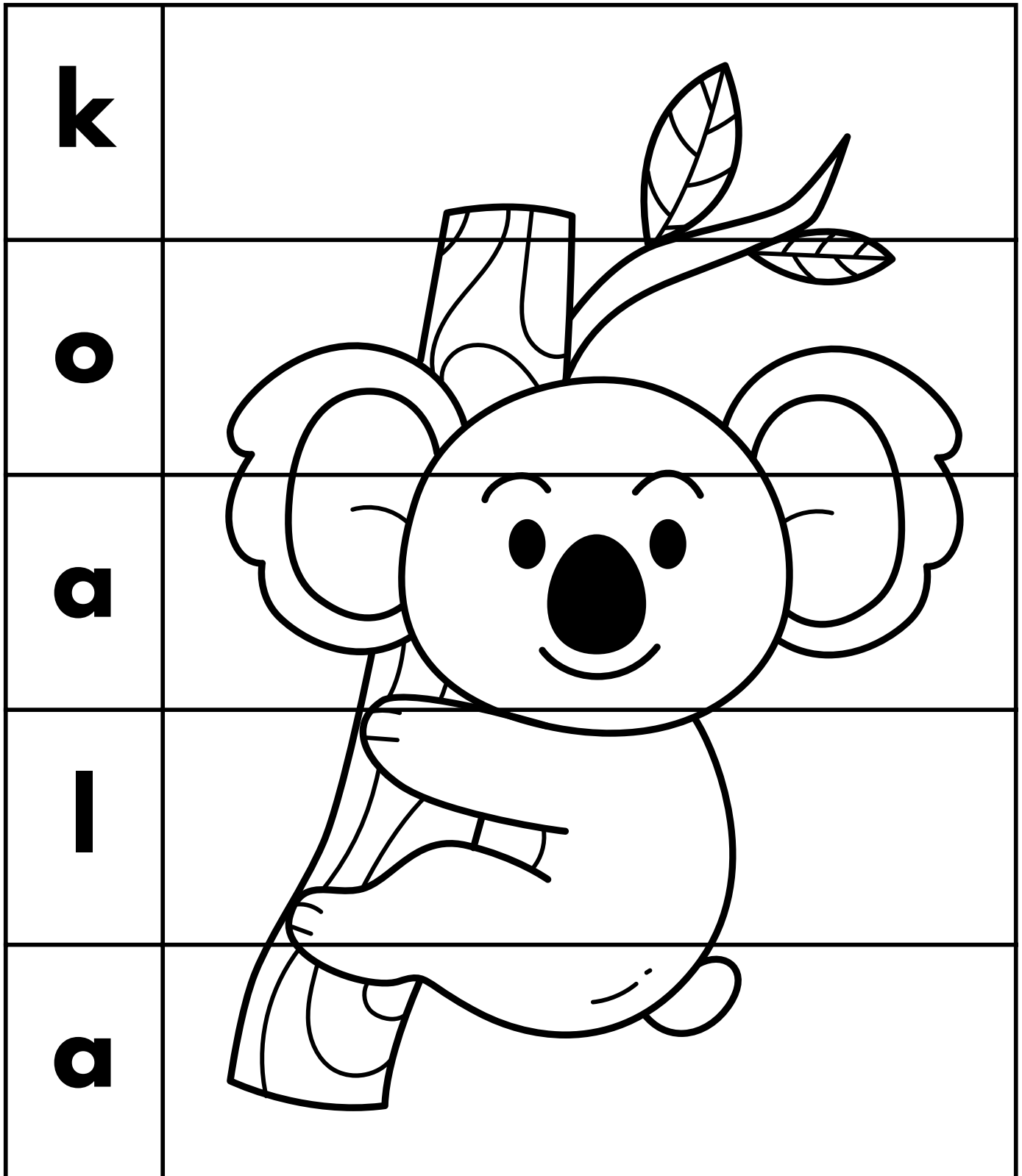

koala



Fill in the missing letters.

k	o	a	l	a
k			l	
	o	a		a

Spell the Word

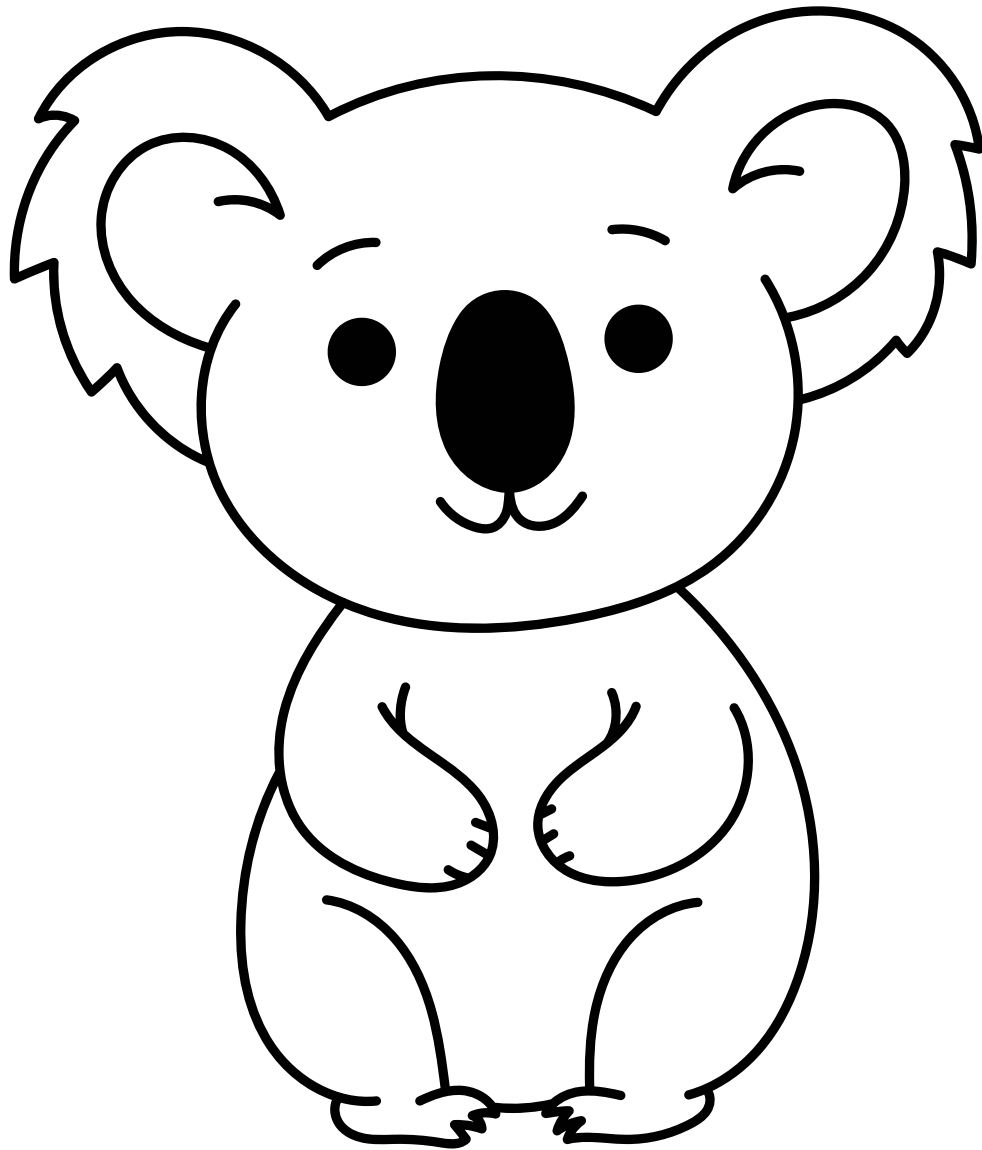

A

L

K

A

O

--	--	--	--	--

Koala find the shadow

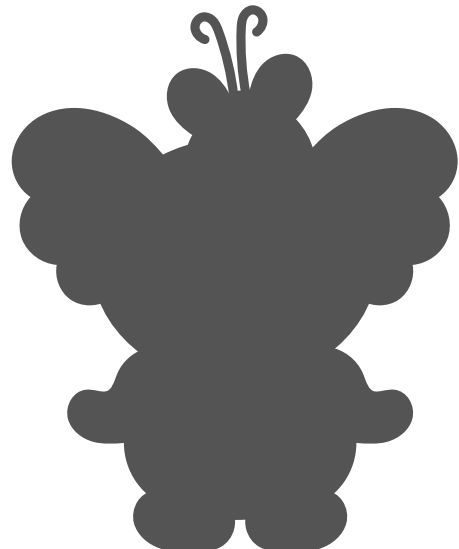
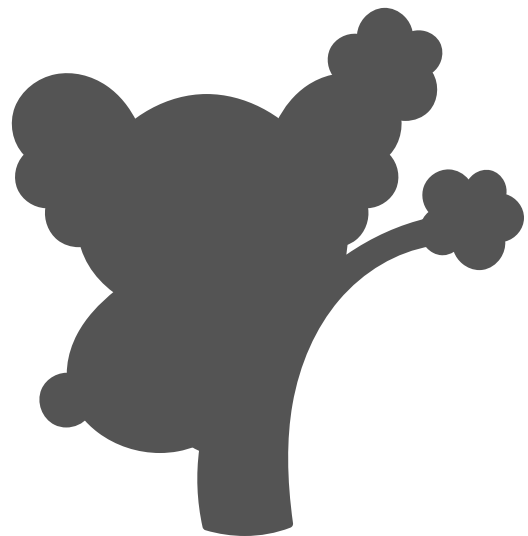
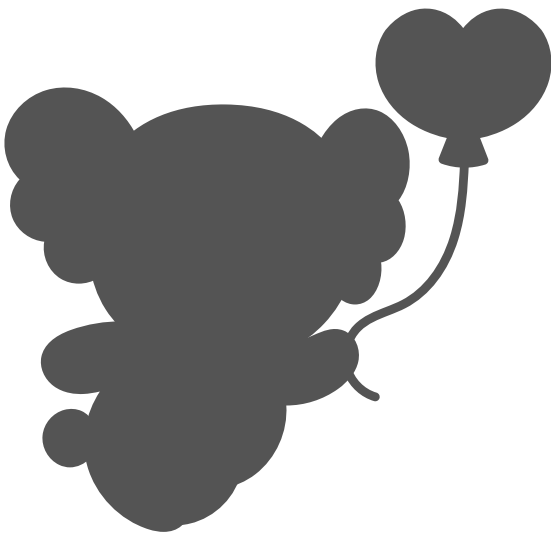
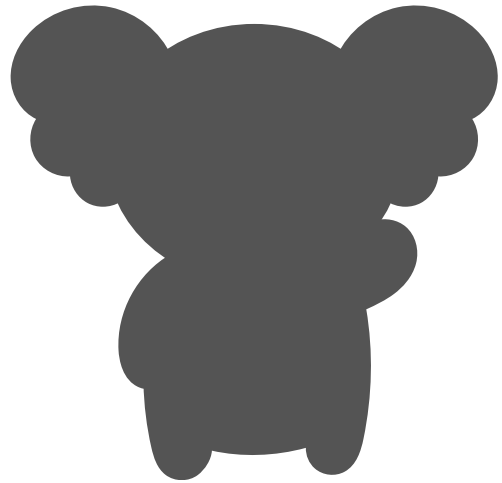

Koala find the same picture

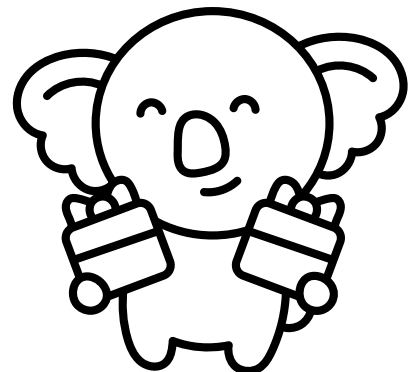
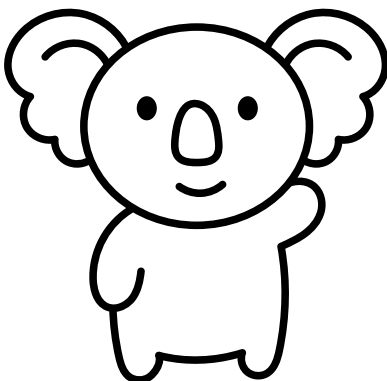
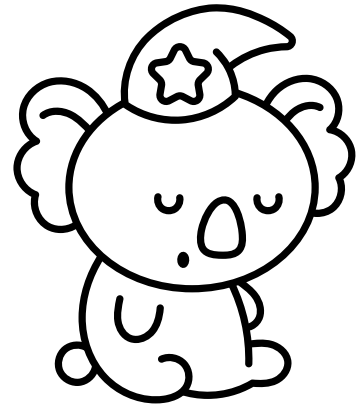
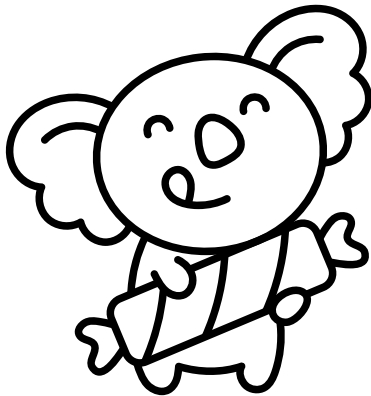
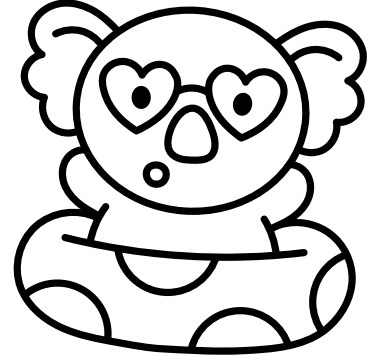
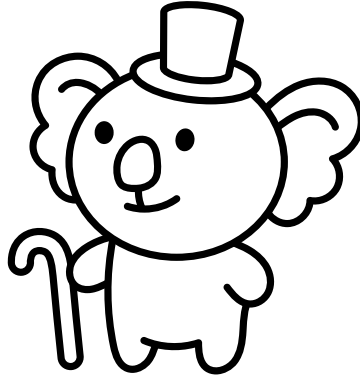
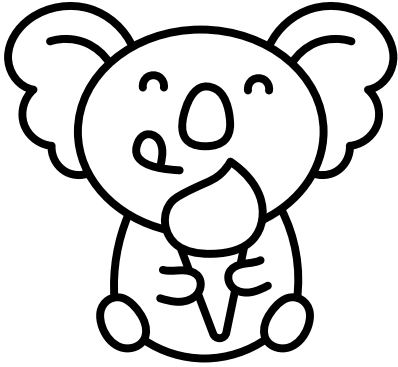

Koala find the odd one out

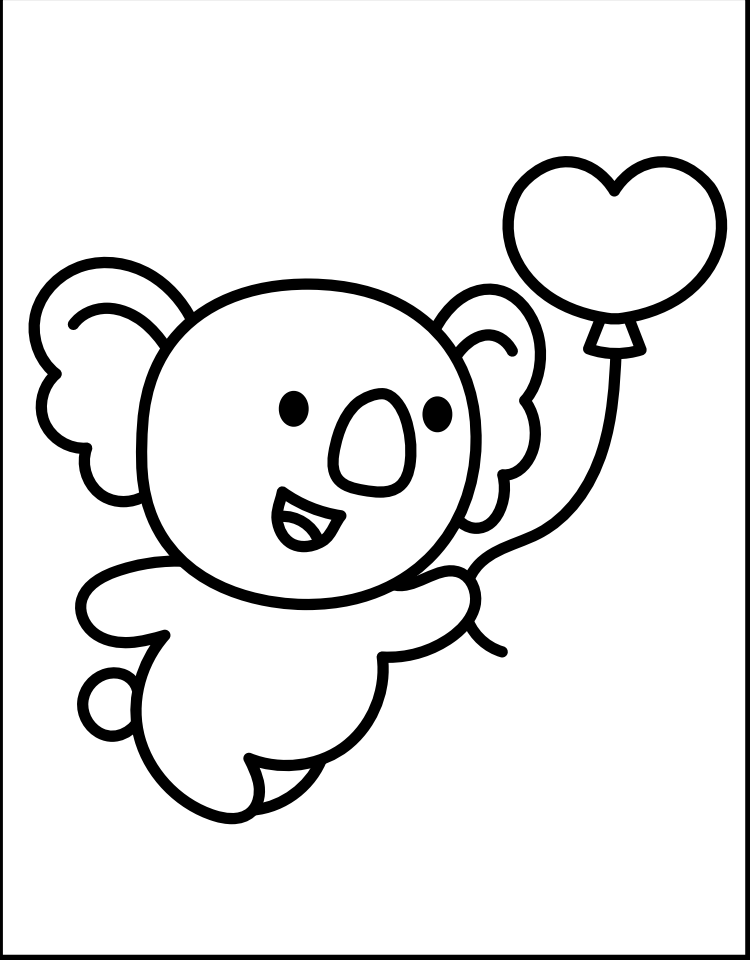
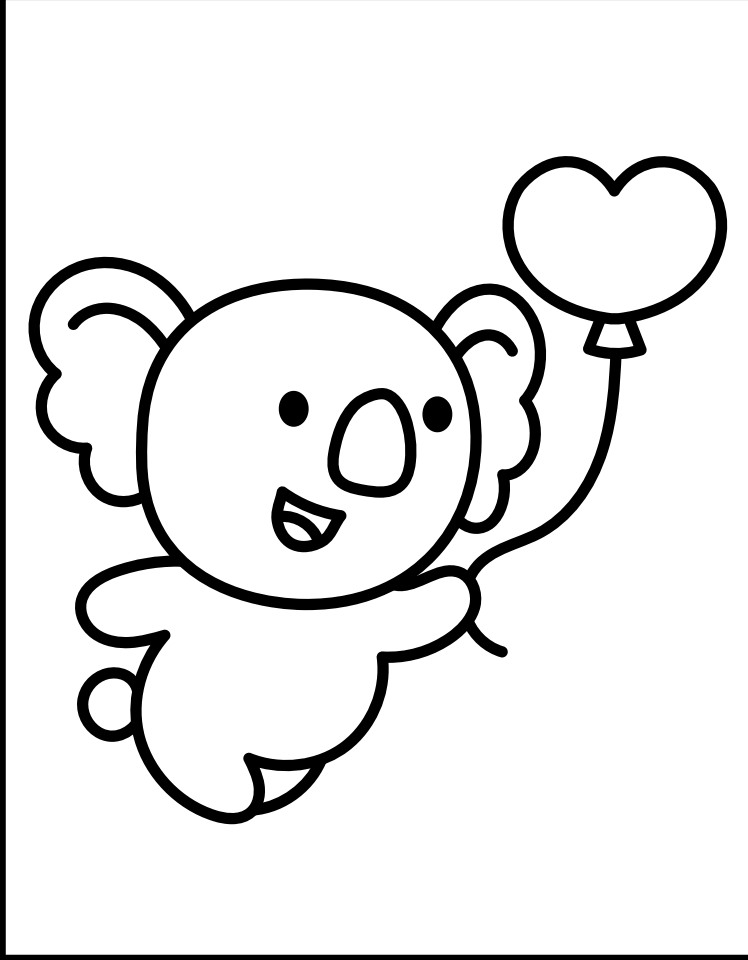
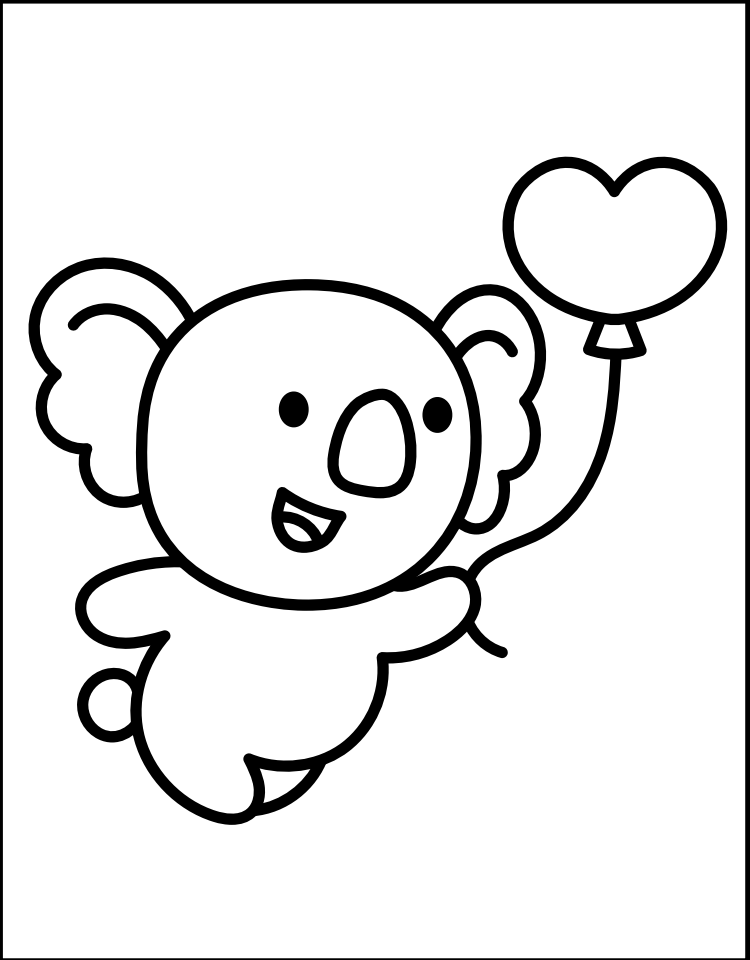
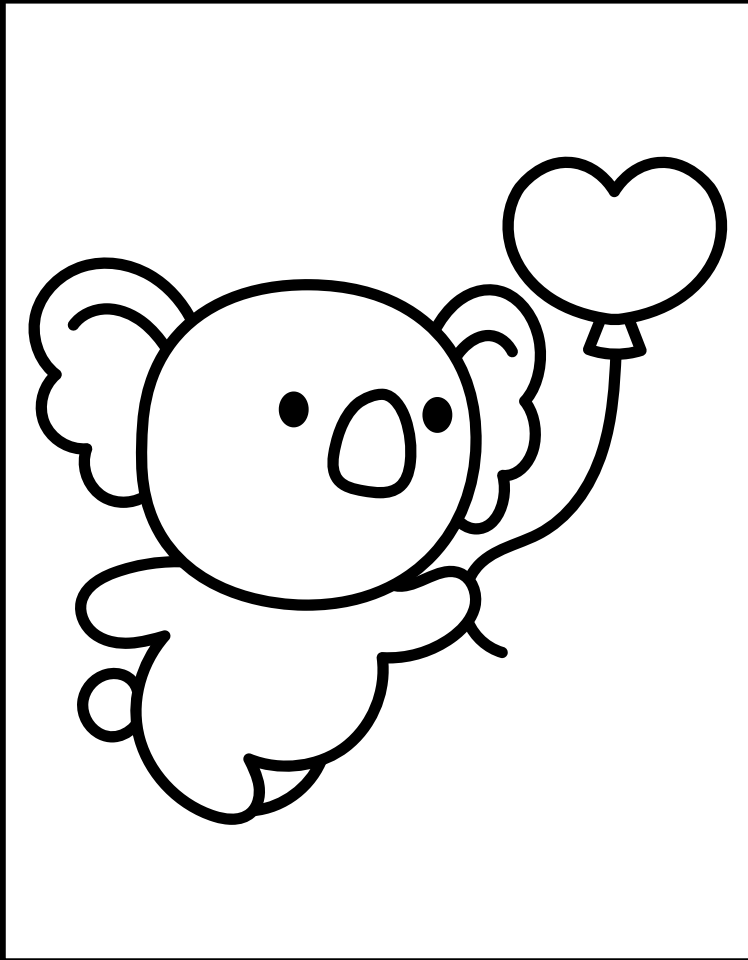

Koala I Spy

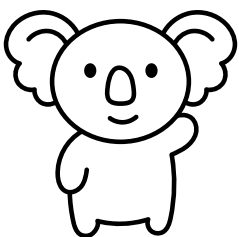
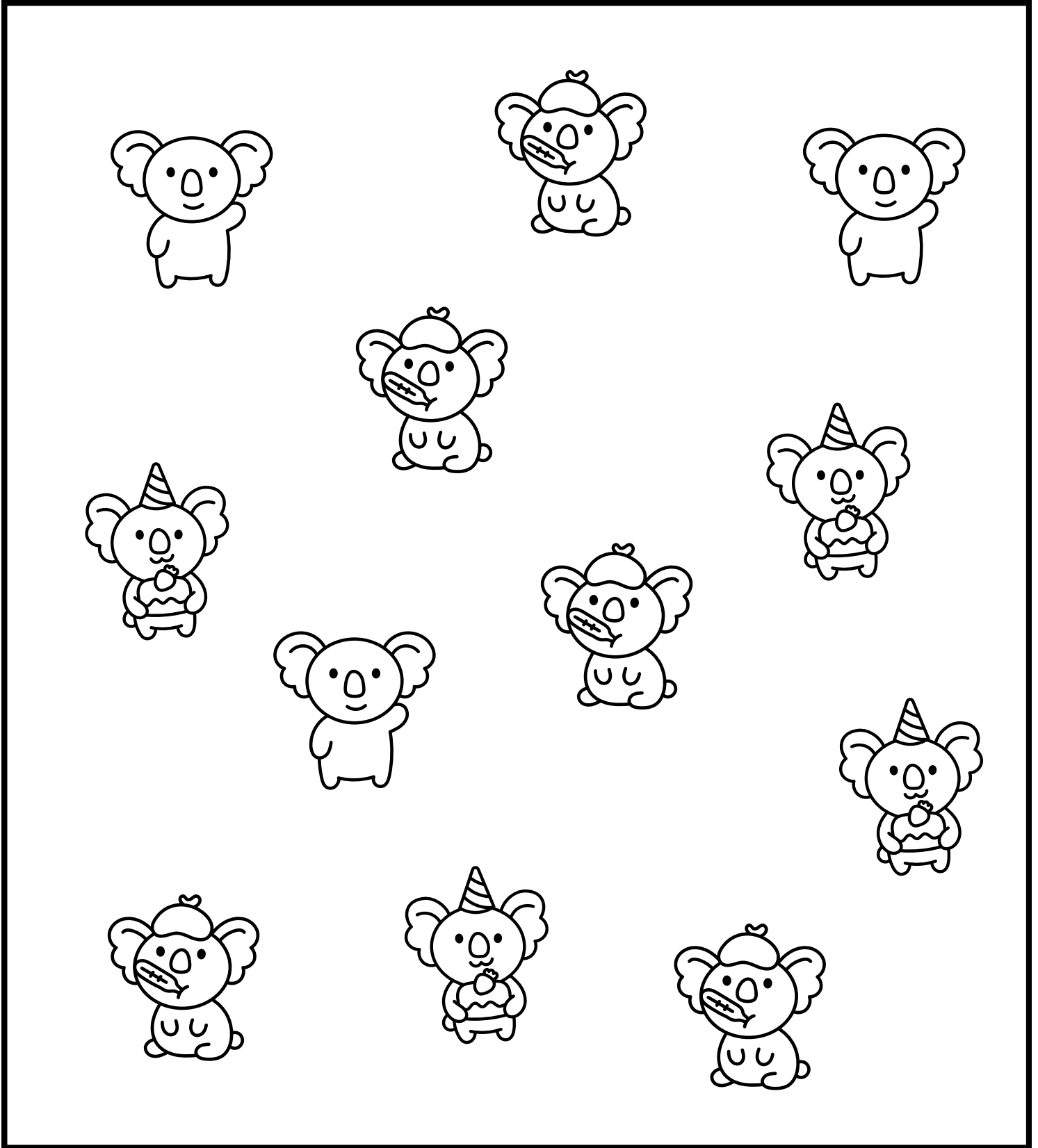

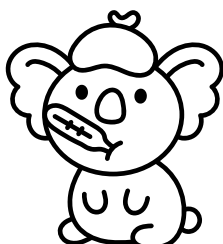



Koala Coloring

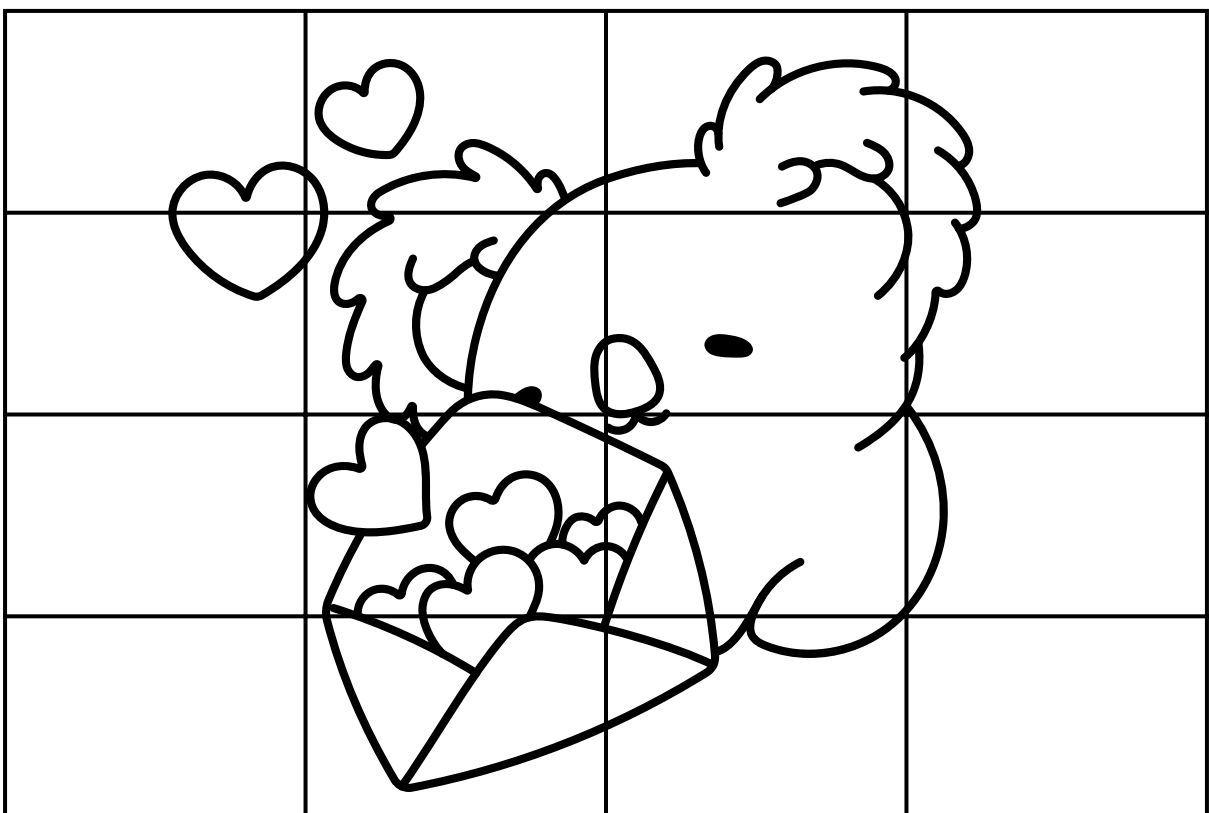
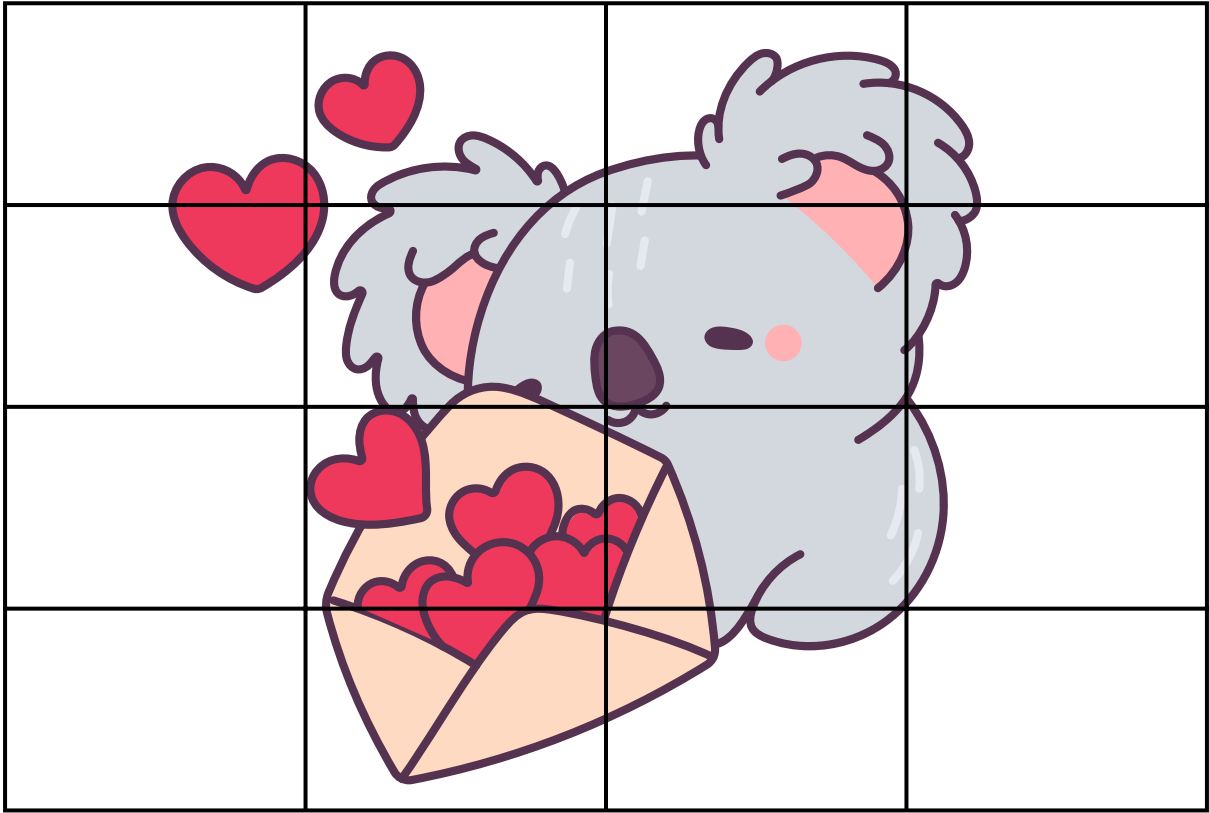

Koala Coloring

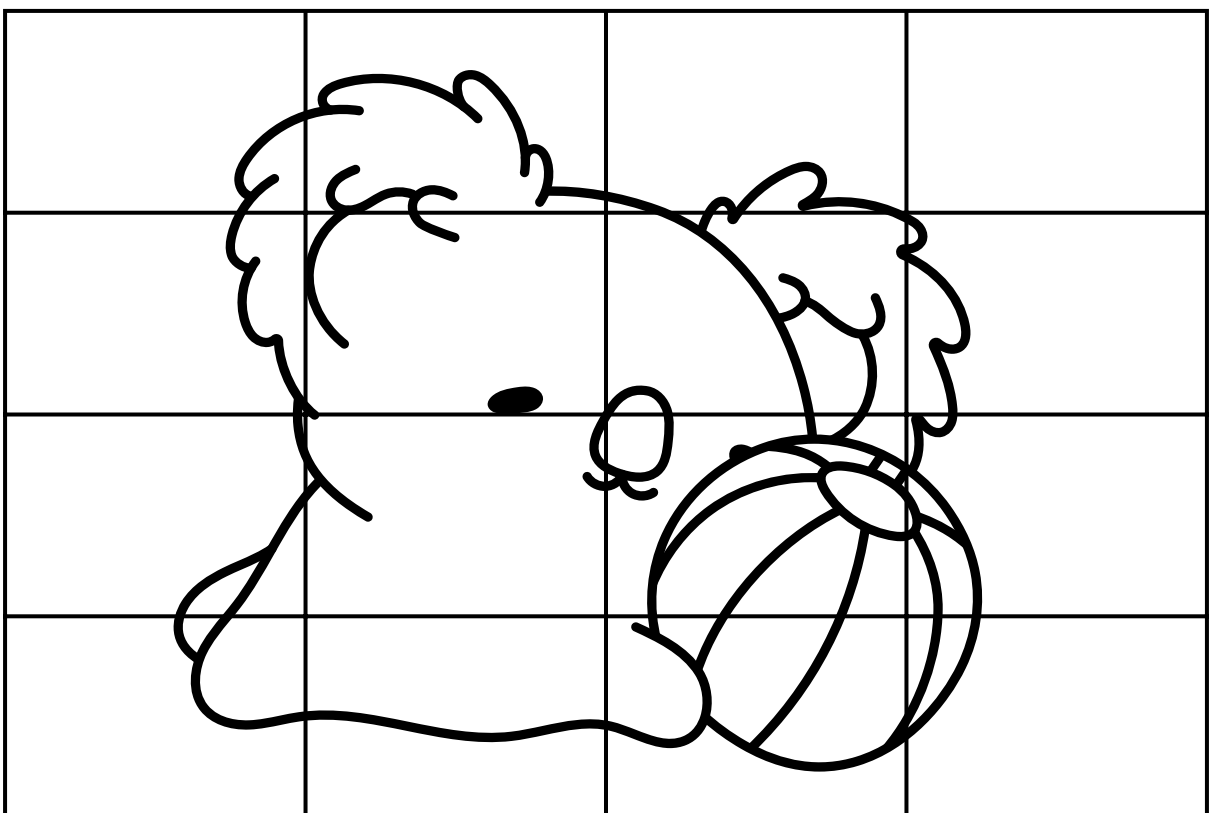
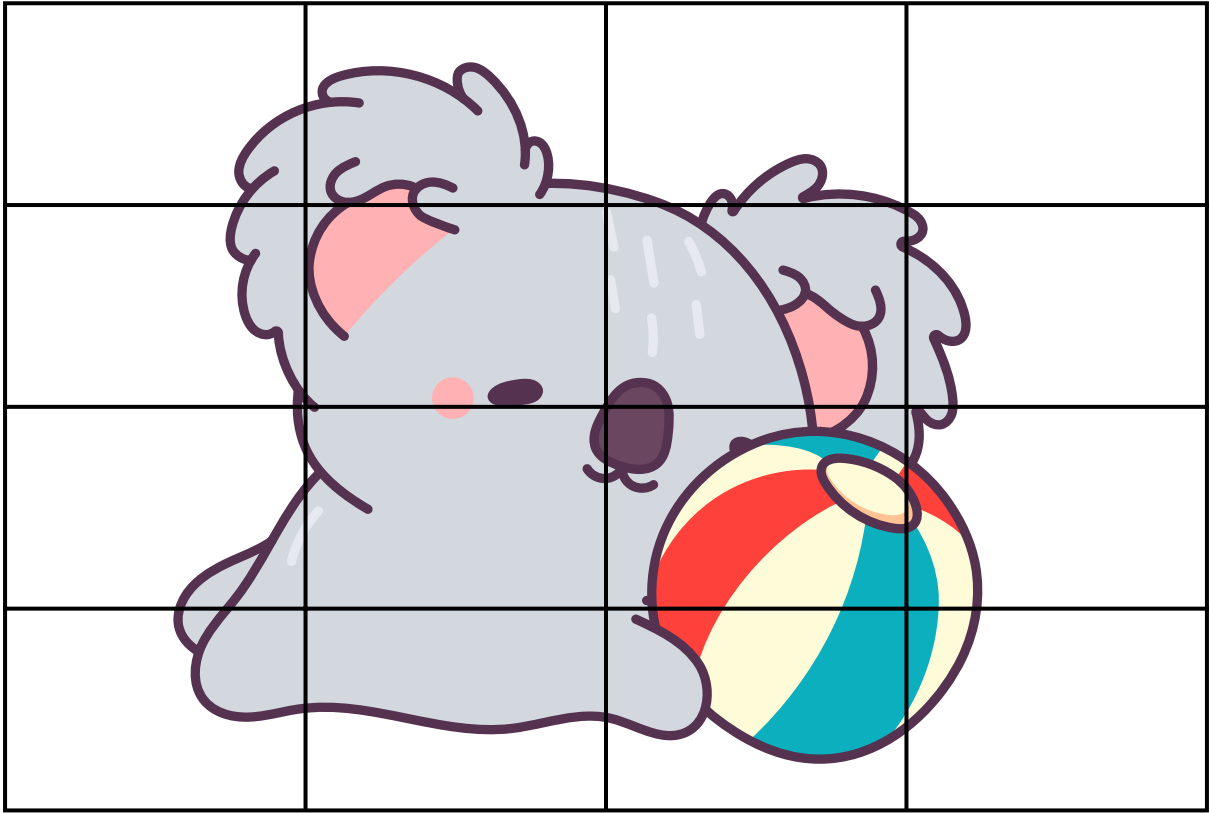

Koala Coloring

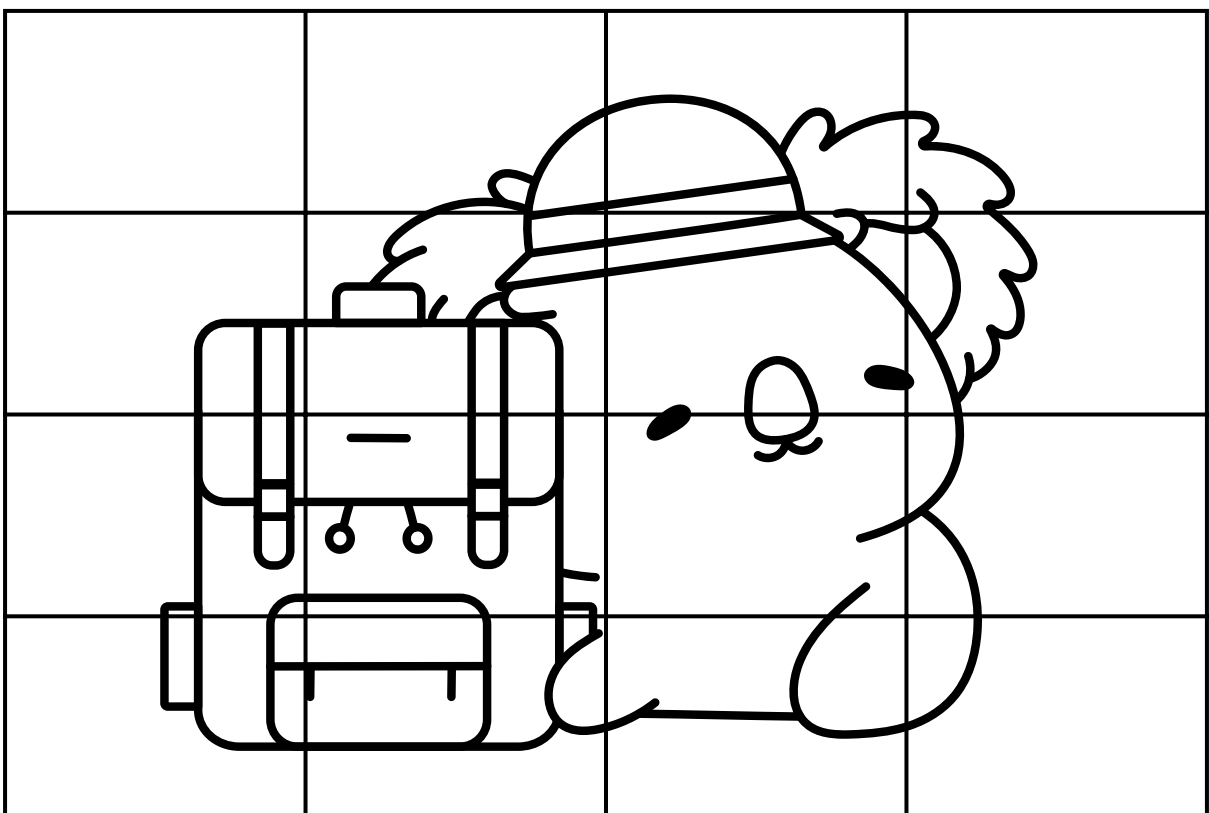
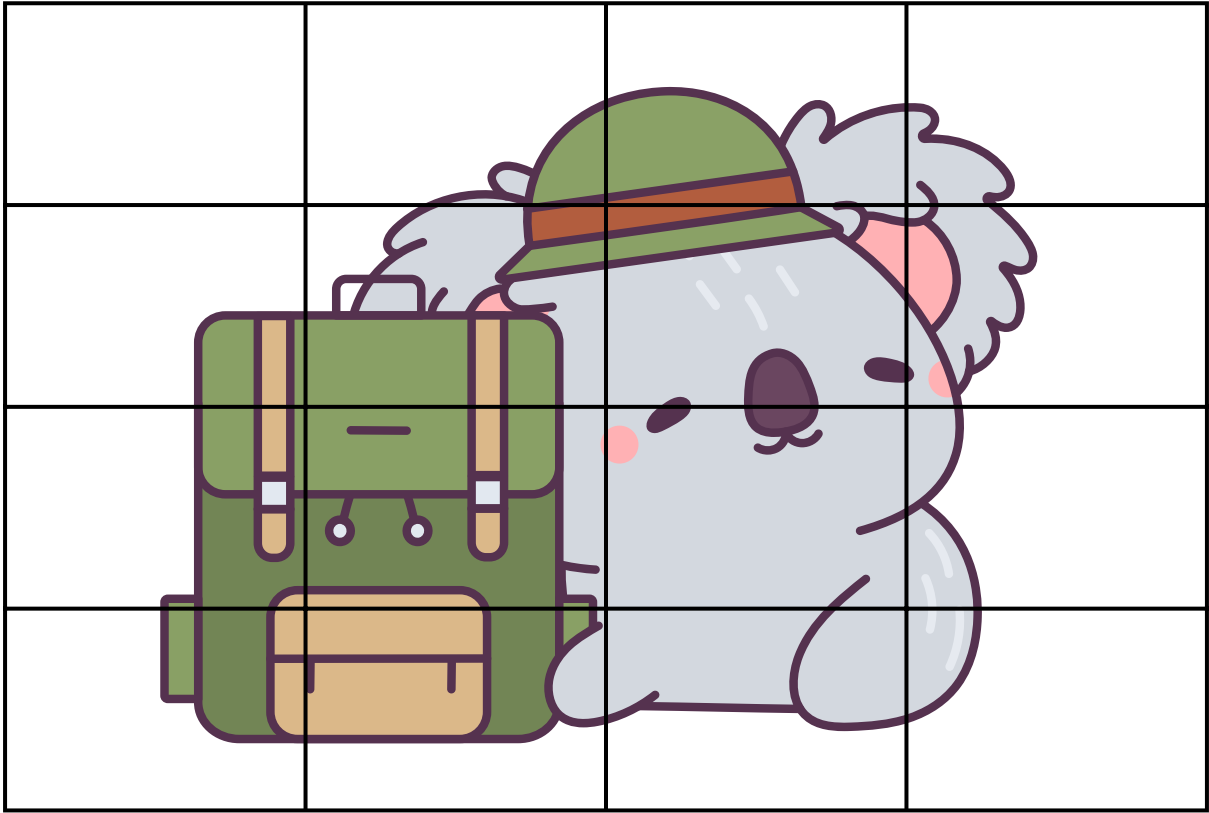

Koala Coloring

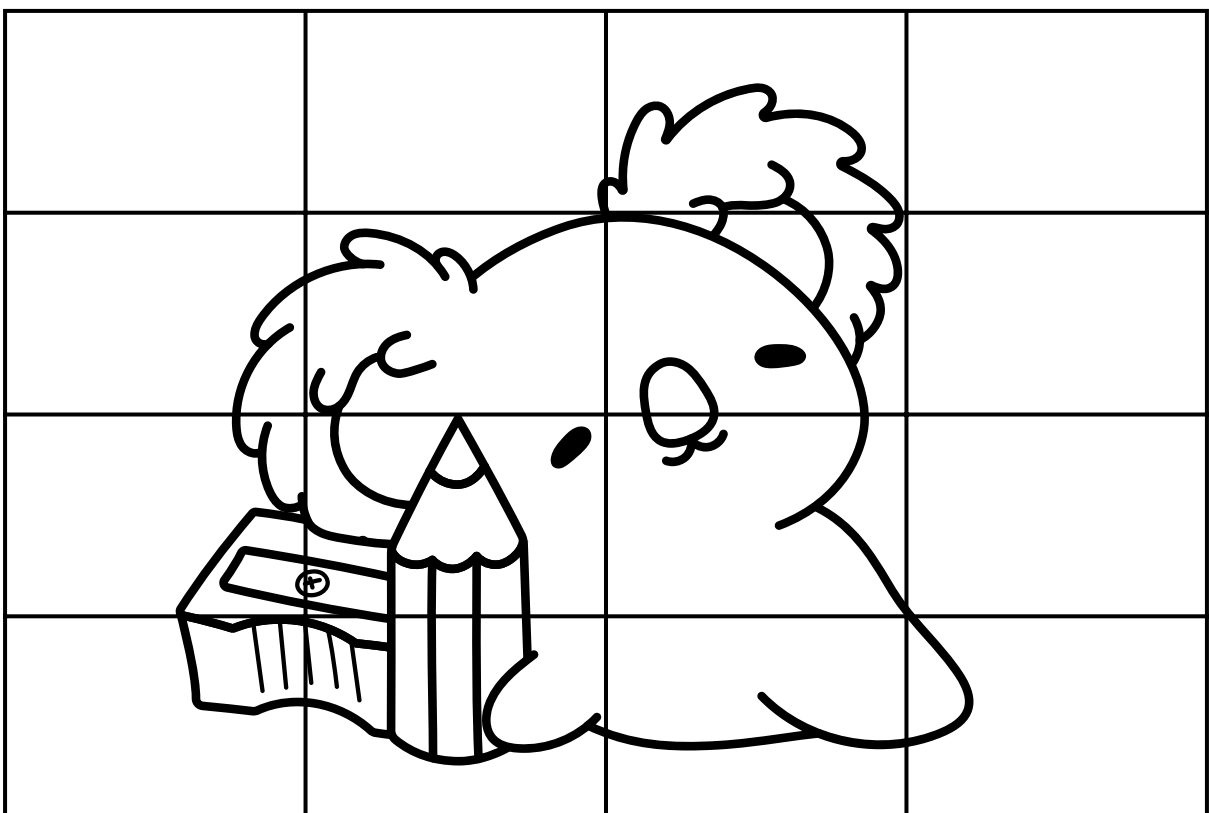
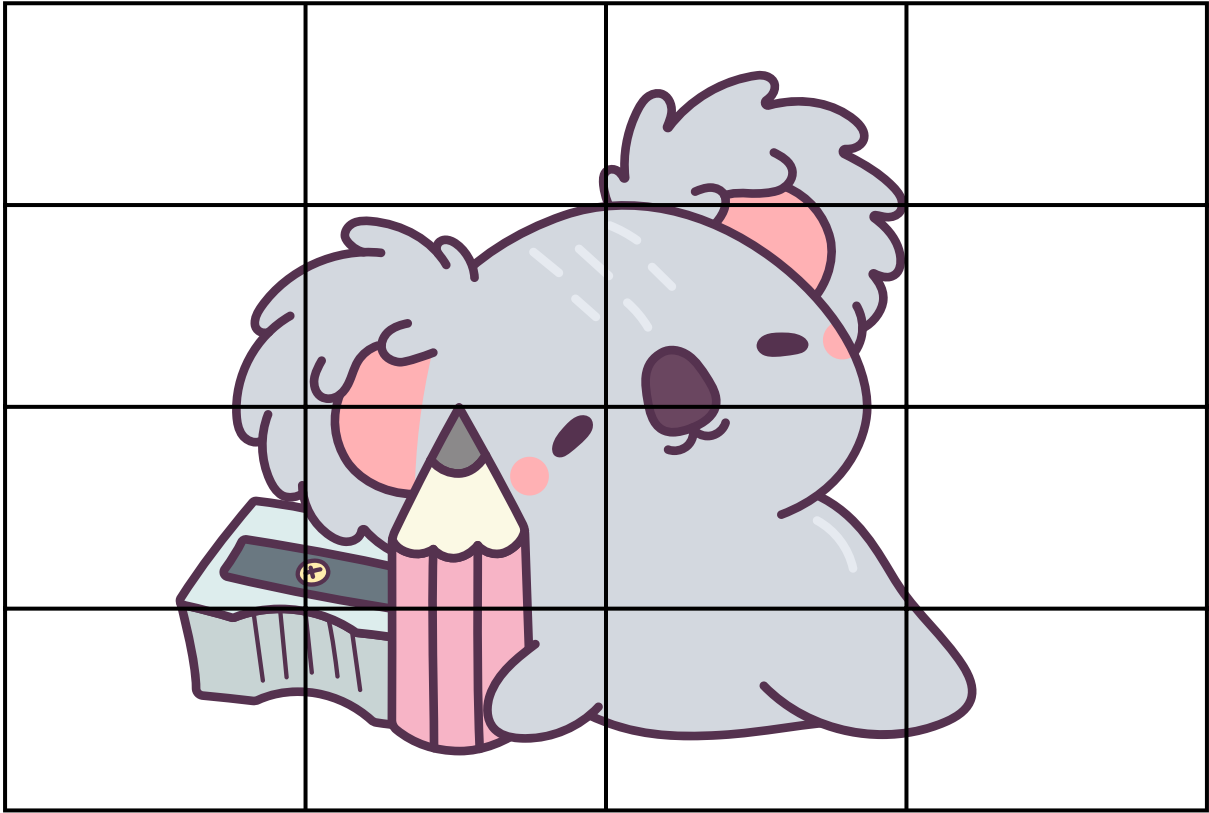

Koala Coloring

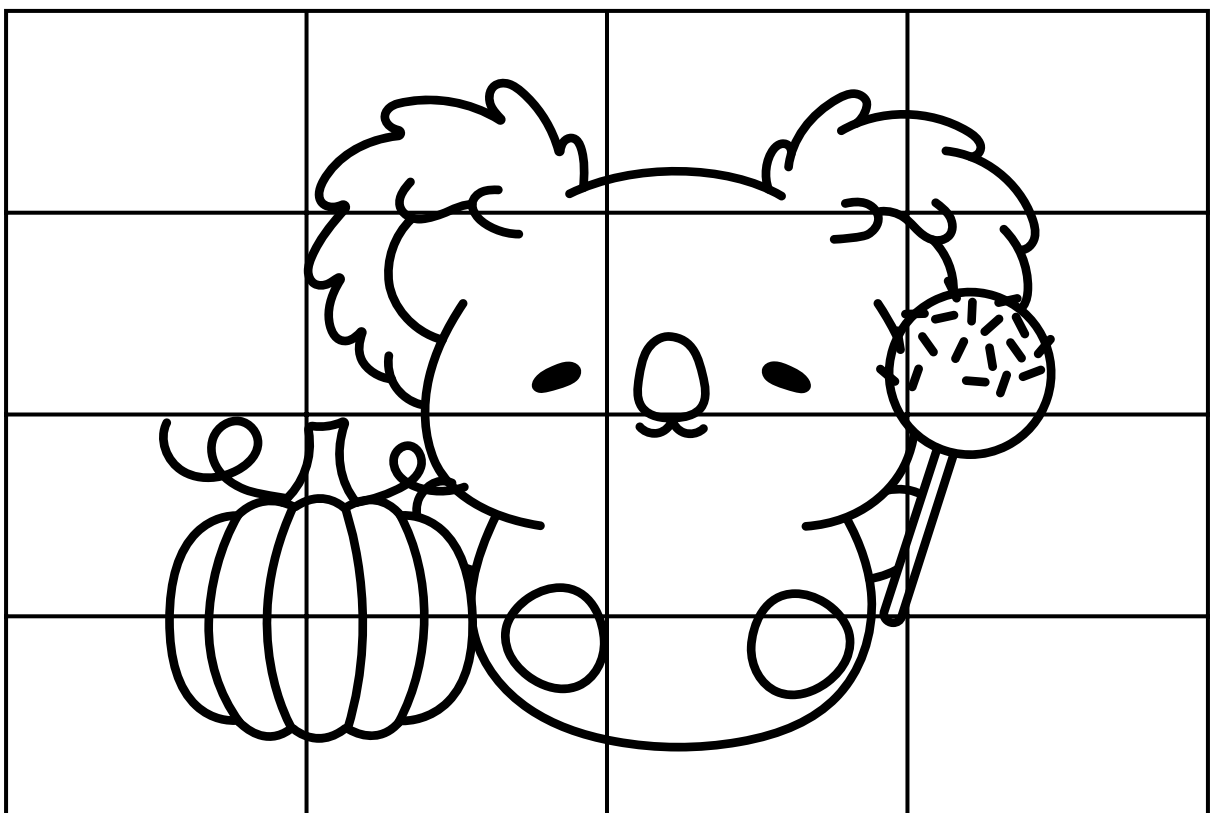
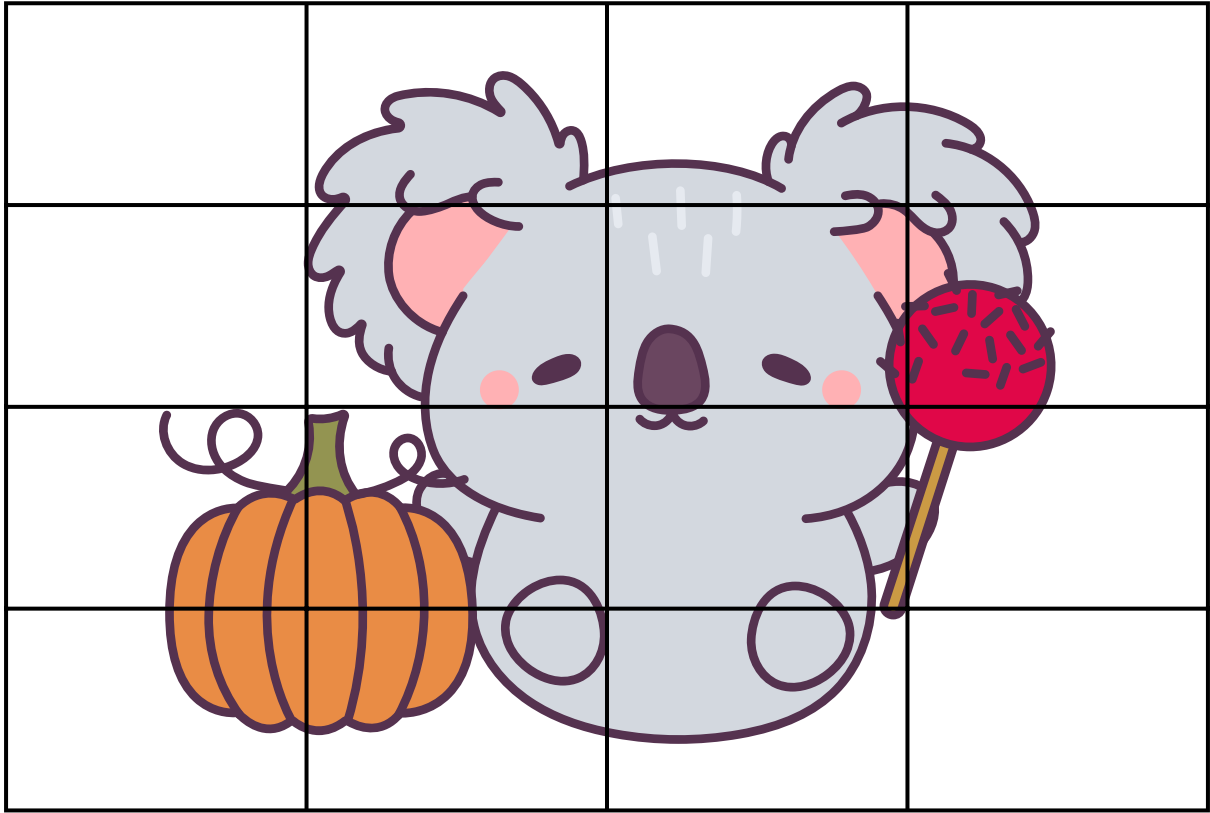

Koala Coloring

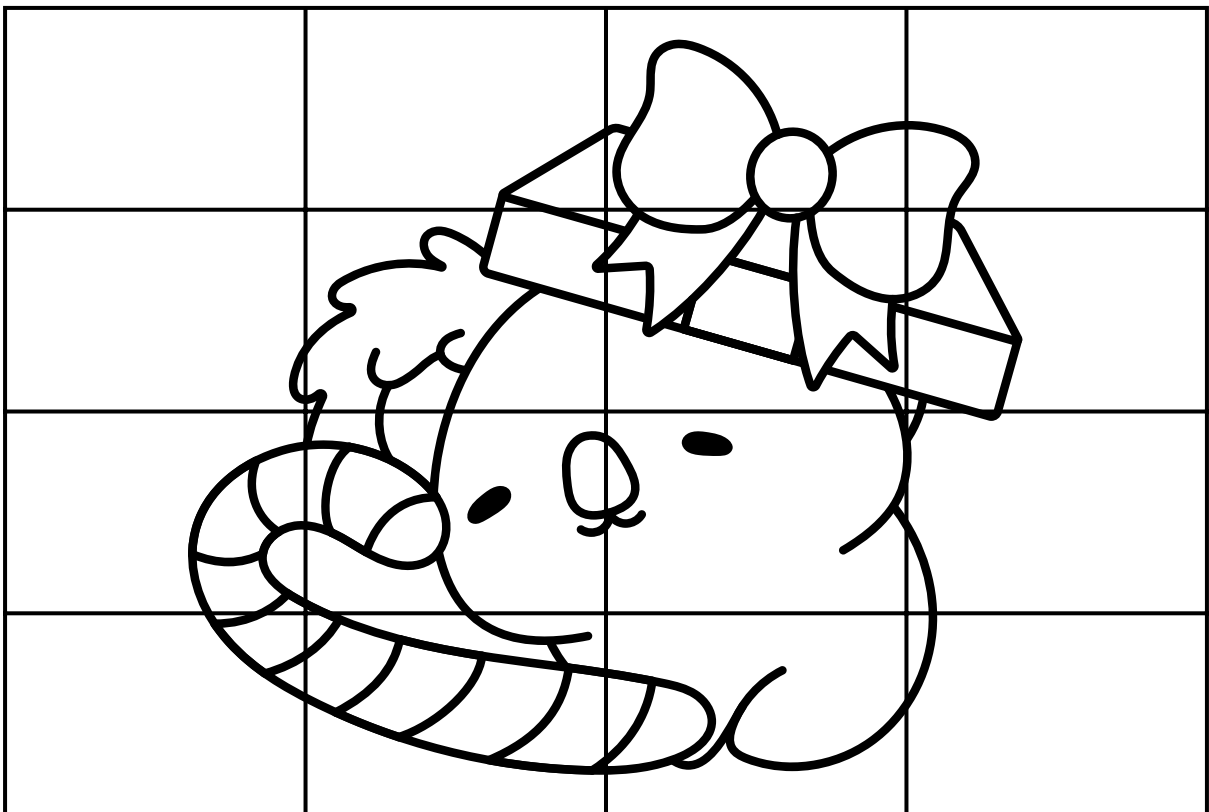
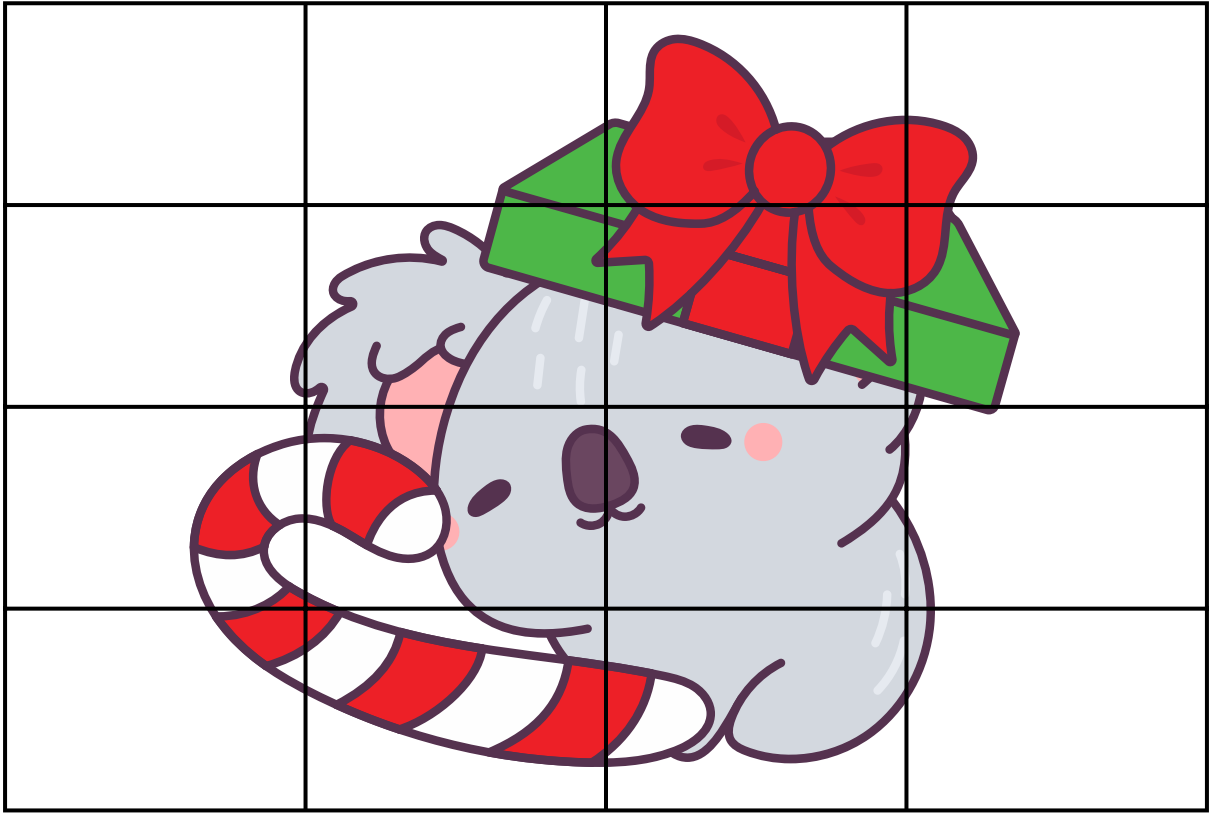



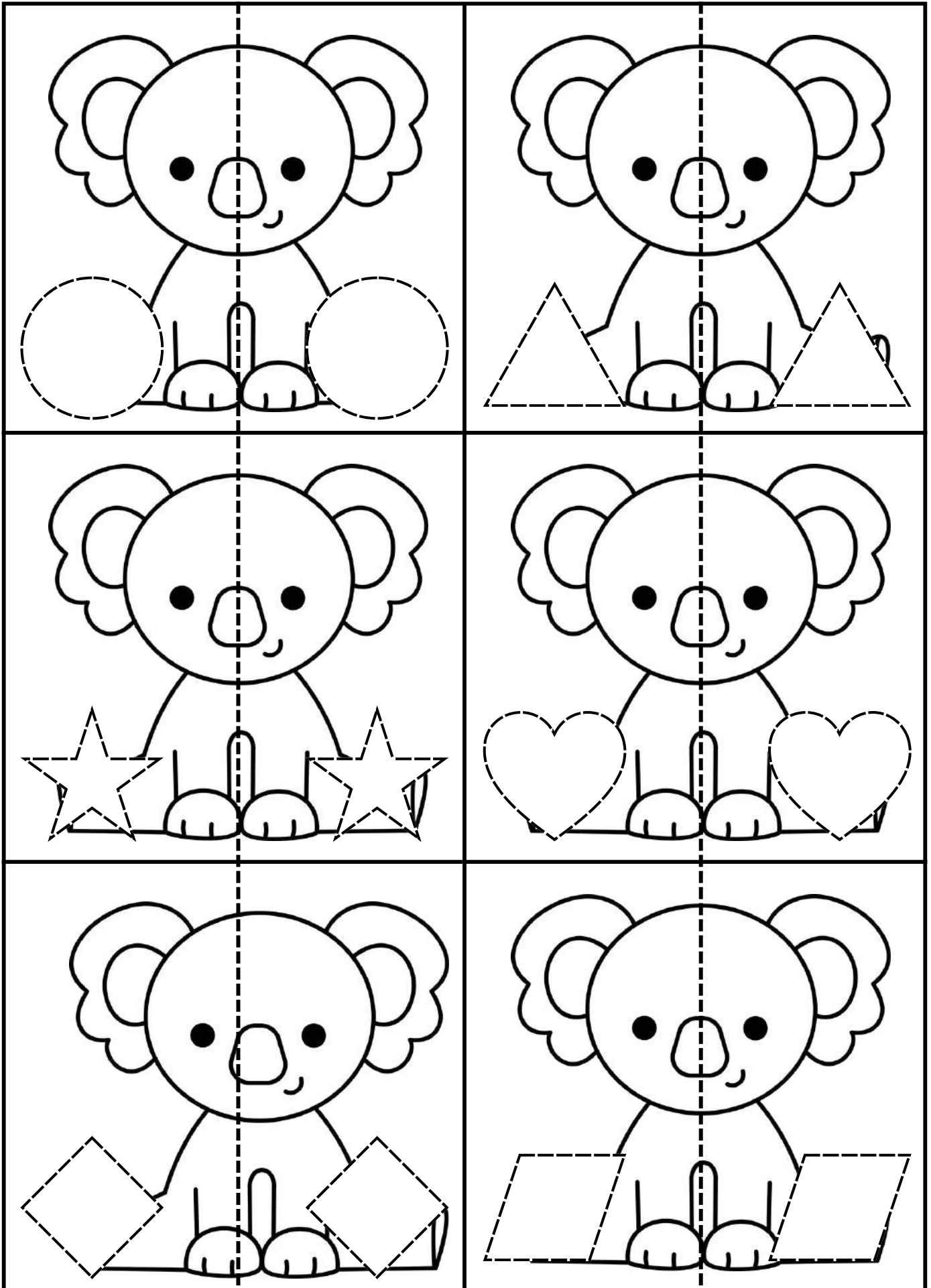



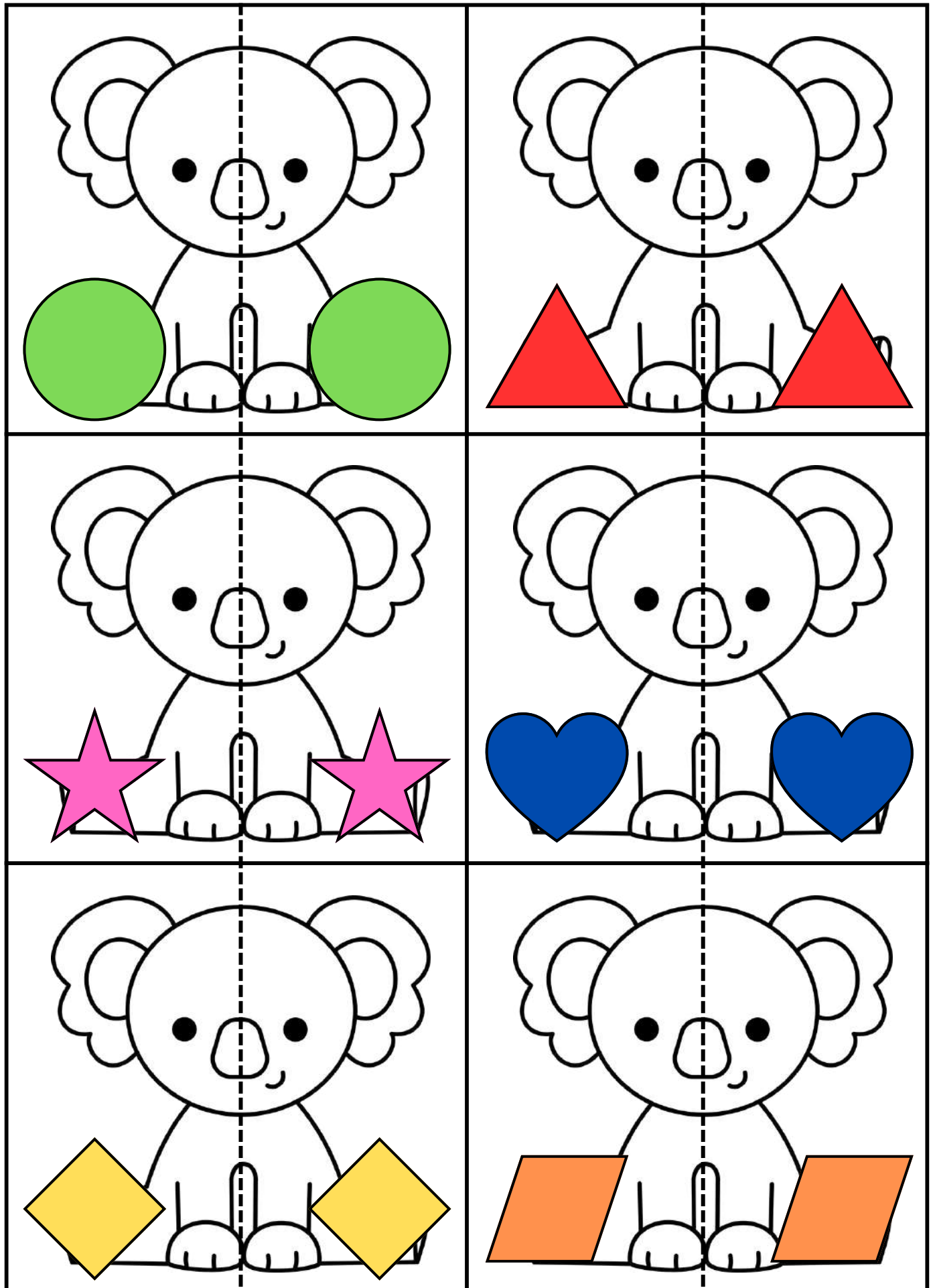

Shapes with Koala: Learn & Match

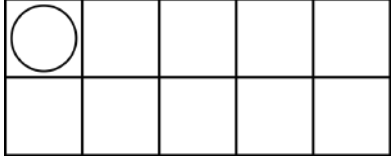

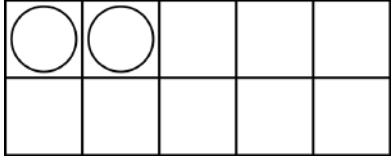
Colors with Koala: Learn & Match

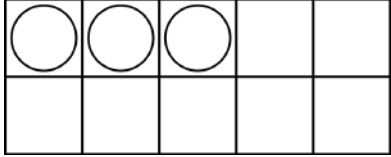

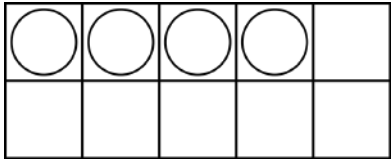
Numbers with Koala: Learn & Match

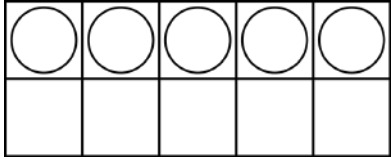
	1	
	2	
	3	
	4	
	5	

Koala Addition Practice

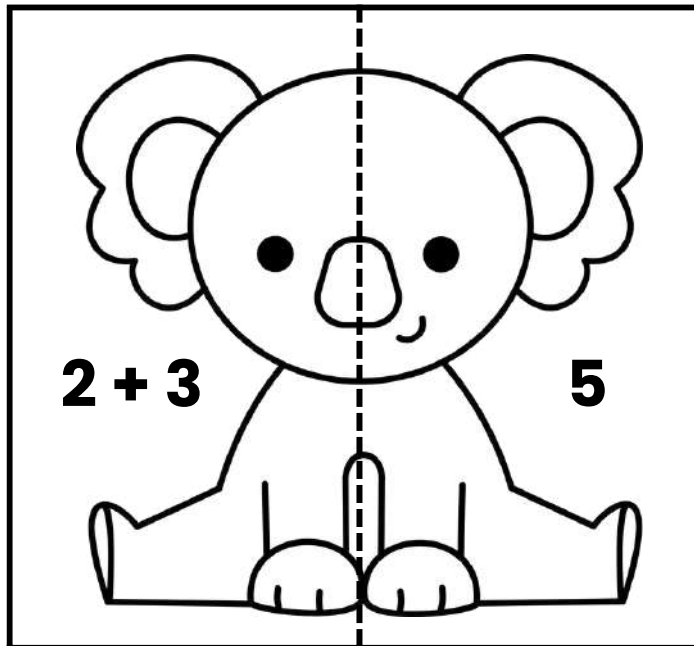
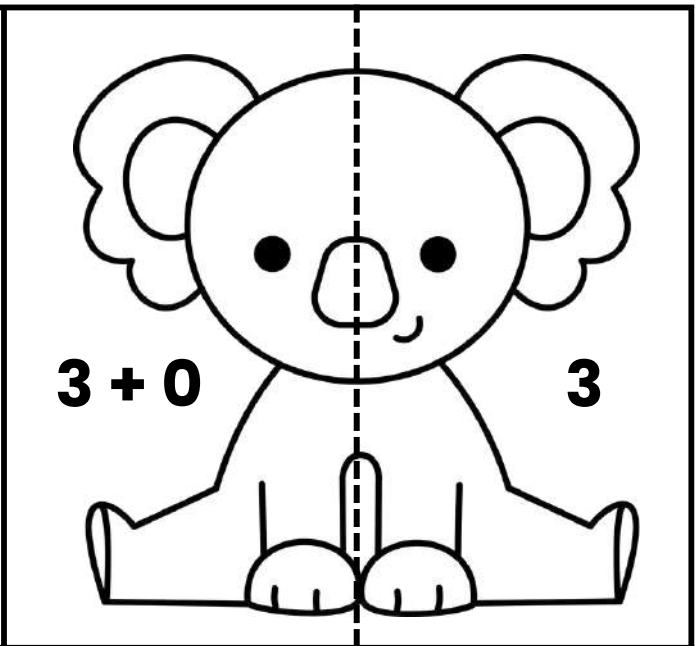
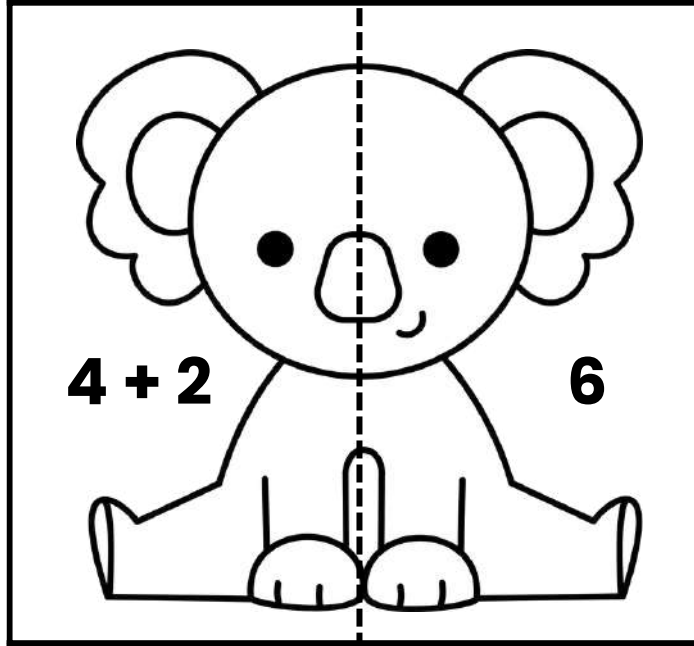
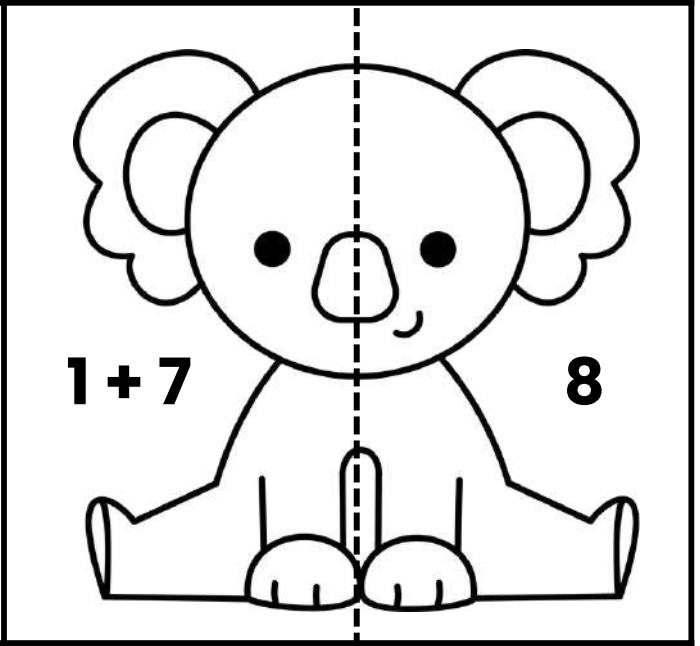
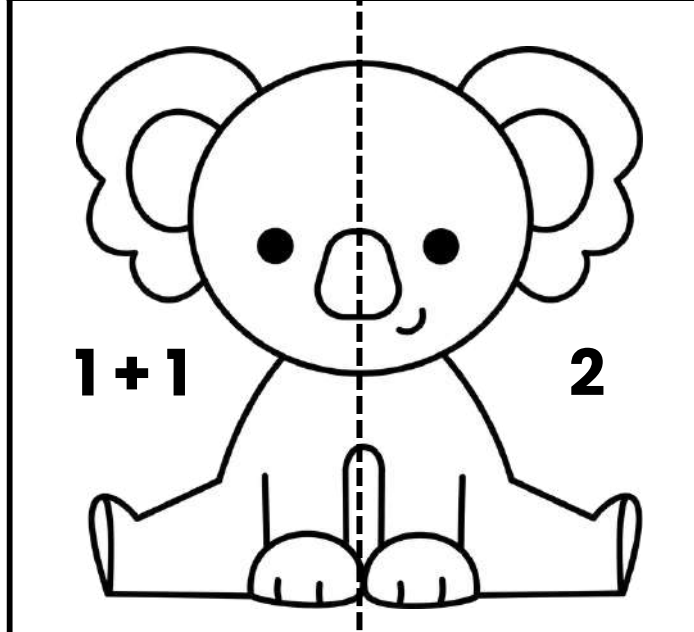
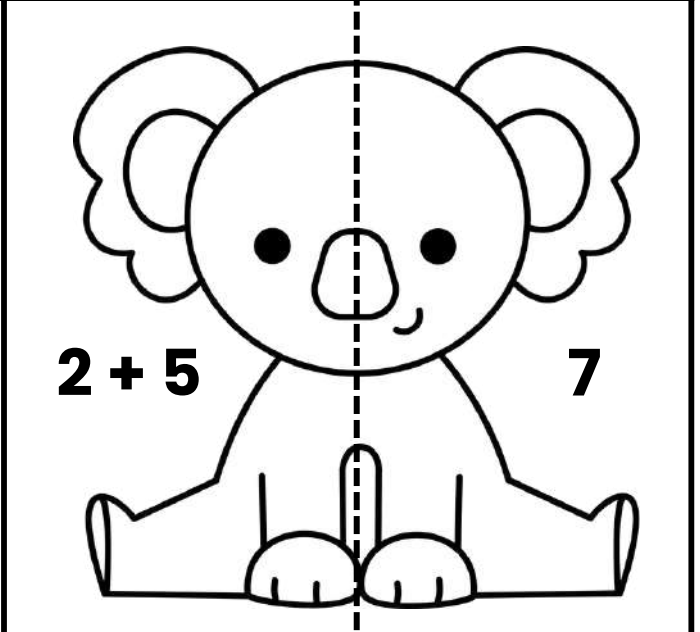
 <p>$2 + 3$ 5</p>	 <p>$3 + 0$ 3</p>
 <p>$4 + 2$ 6</p>	 <p>$1 + 7$ 8</p>
 <p>$1 + 1$ 2</p>	 <p>$2 + 5$ 7</p>

Koala Subtraction Practice

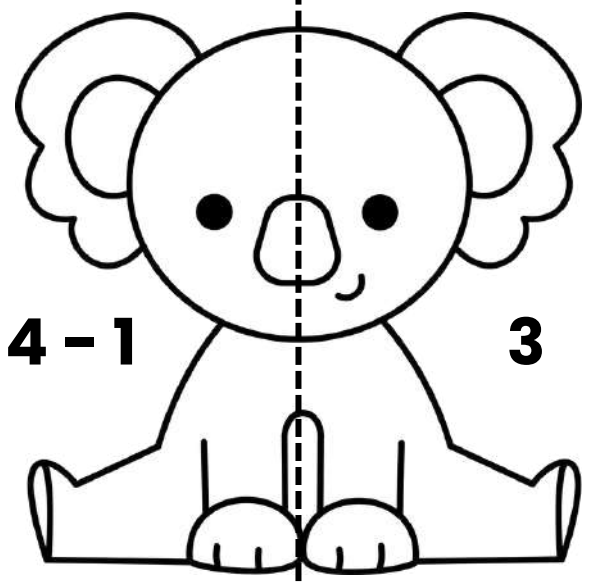
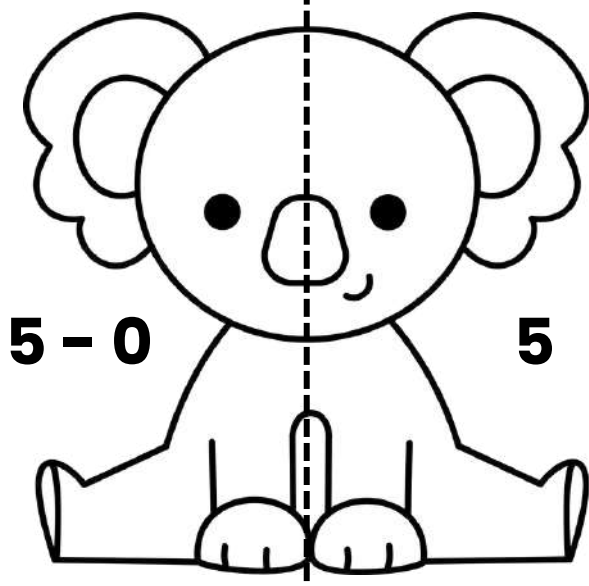
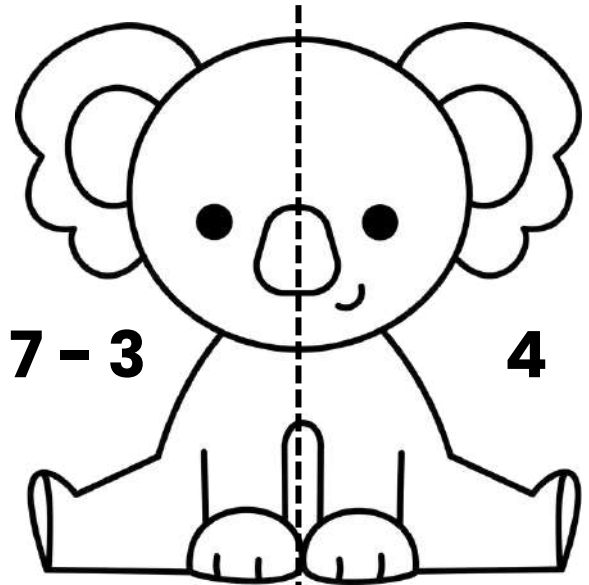
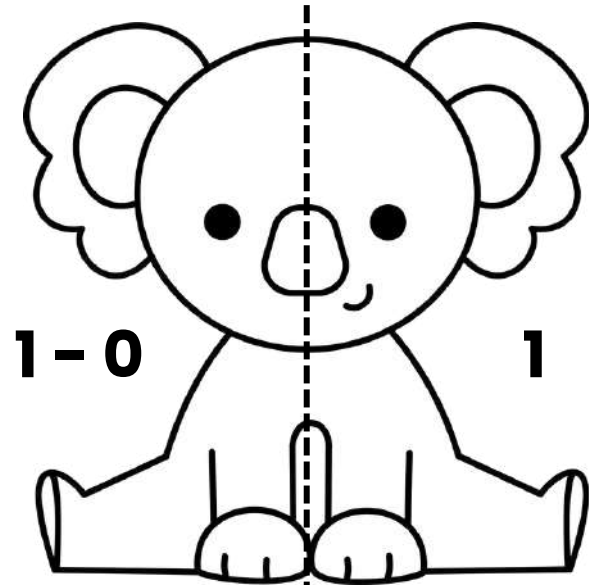
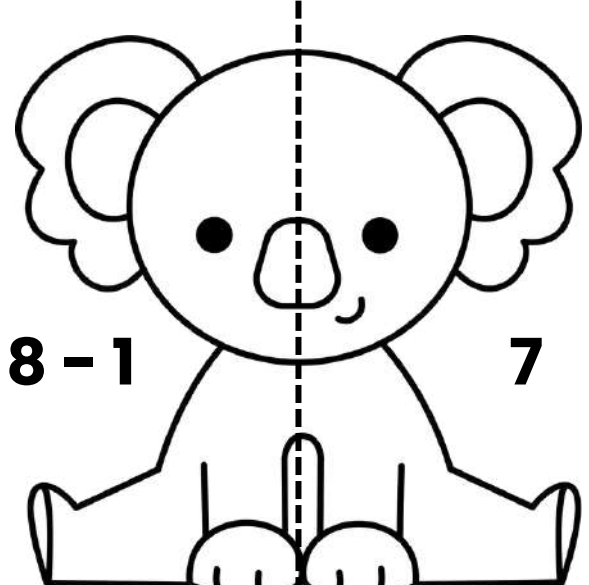
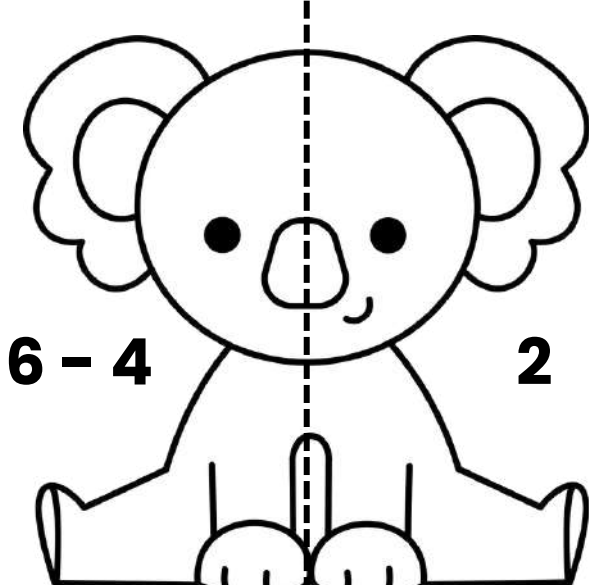
 <p>$4 - 1 = 3$</p>	 <p>$5 - 0 = 5$</p>
 <p>$7 - 3 = 4$</p>	 <p>$1 - 0 = 1$</p>
 <p>$8 - 1 = 7$</p>	 <p>$6 - 4 = 2$</p>

Koala CVC Words - Short a

a

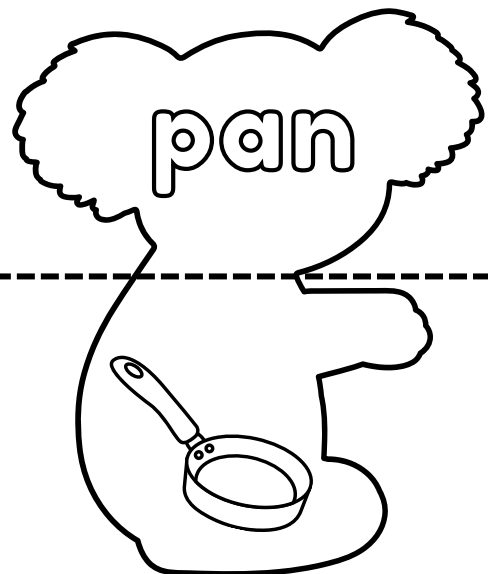
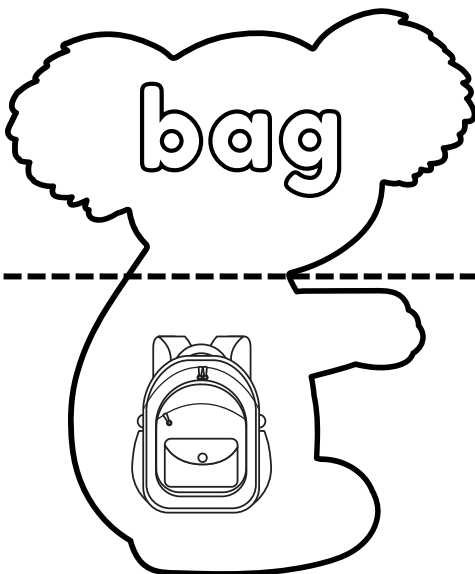
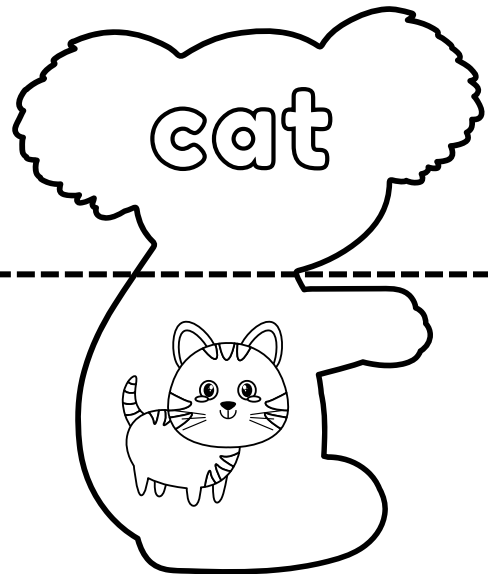
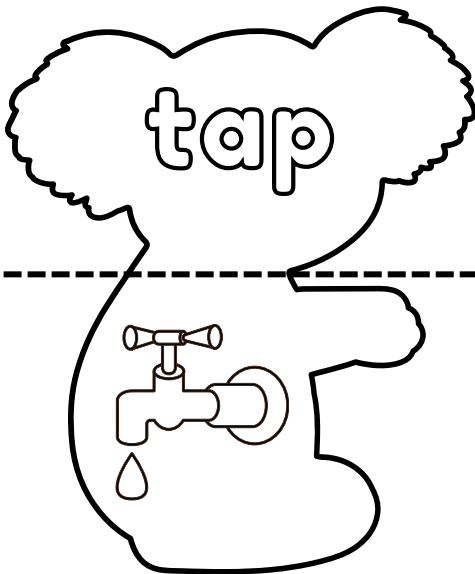
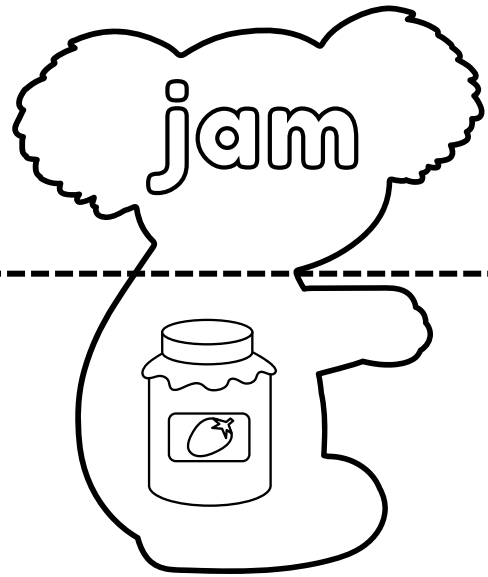

Koala CVC Words - Short e

e

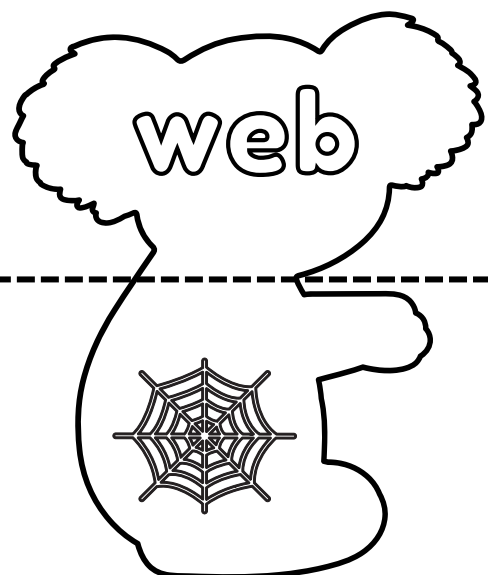
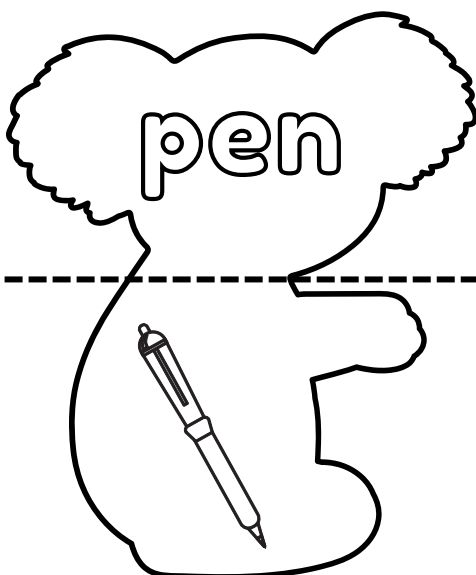
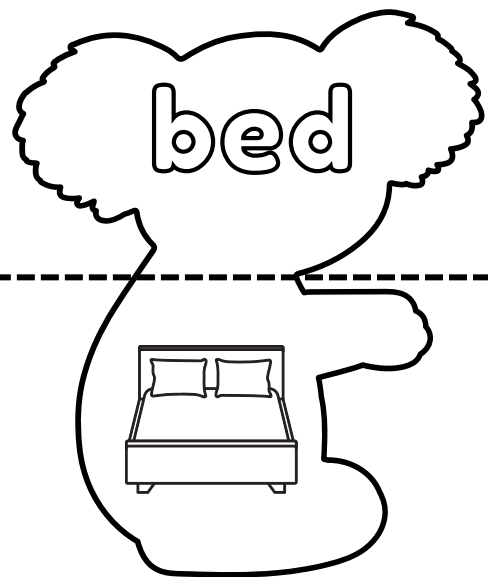
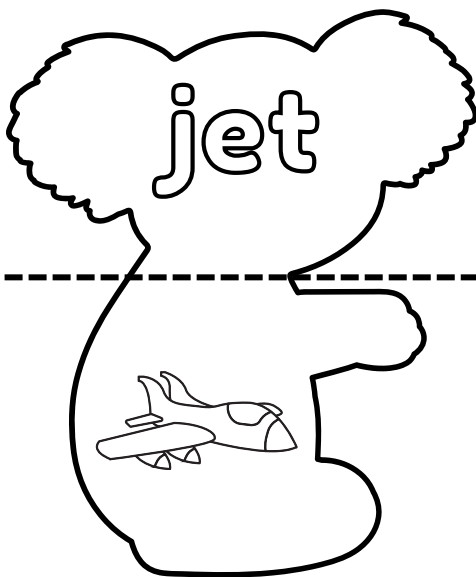
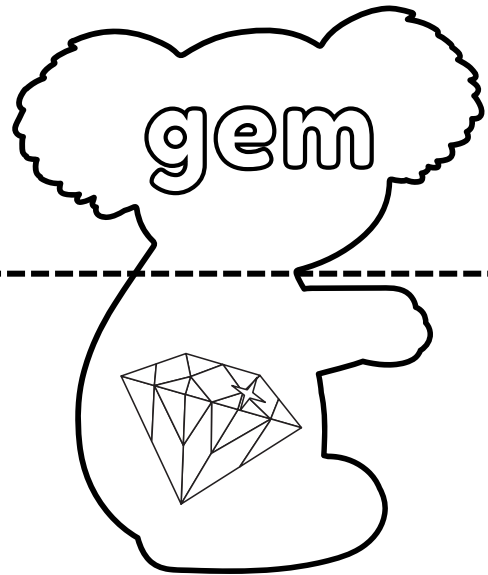

Koala CVC Words - Short i

i

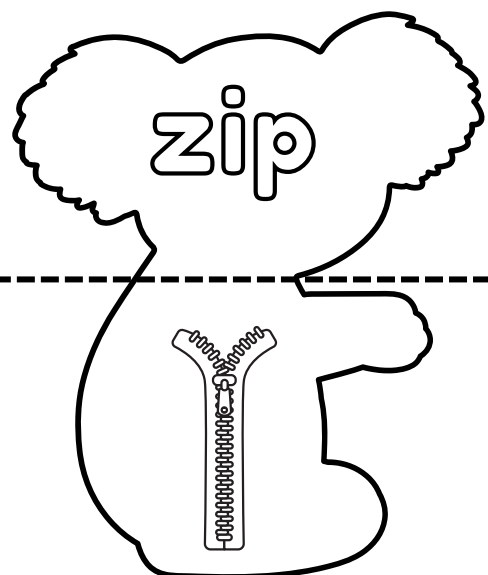
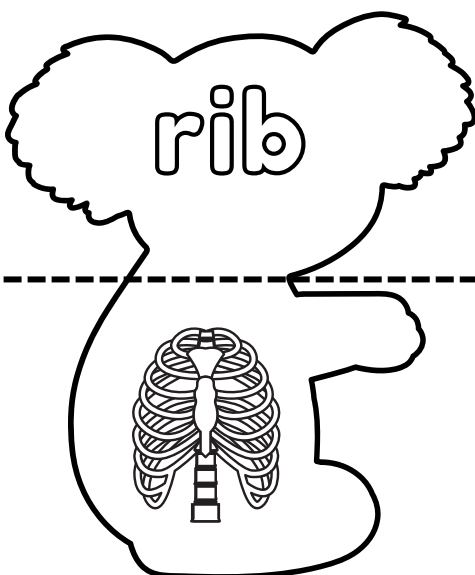
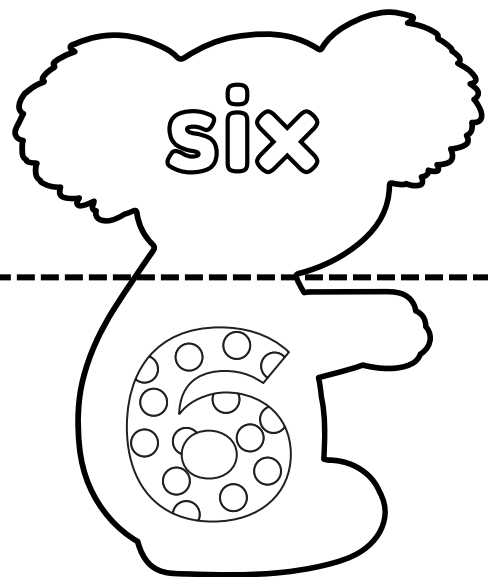
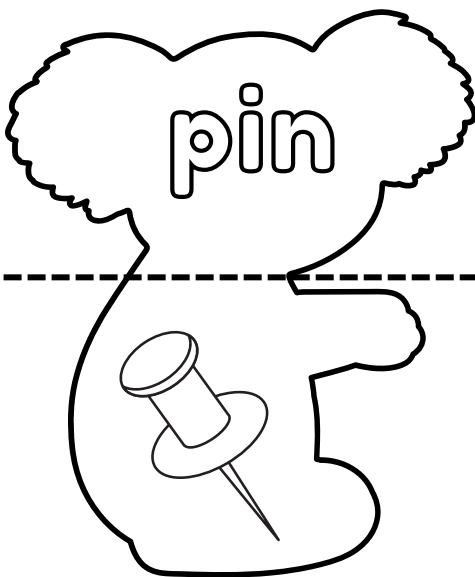

Koala CVC Words - Short o

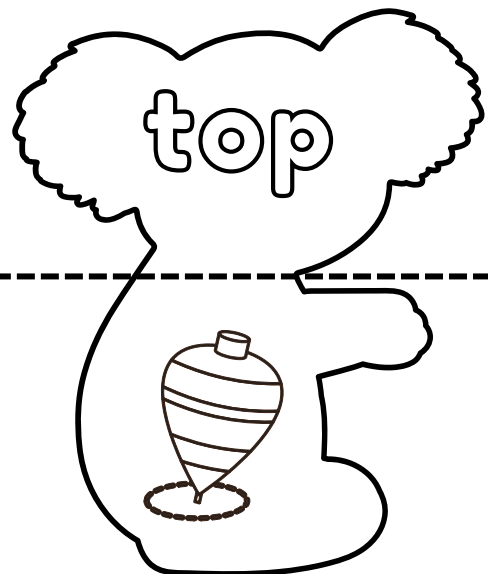
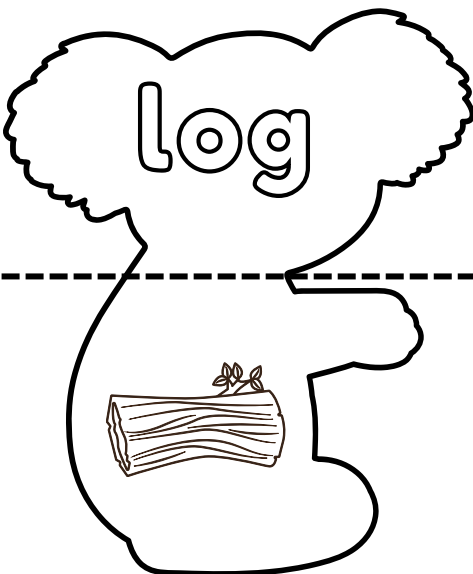
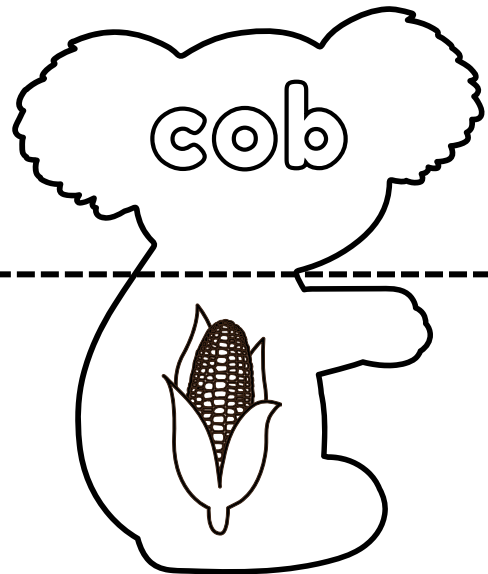
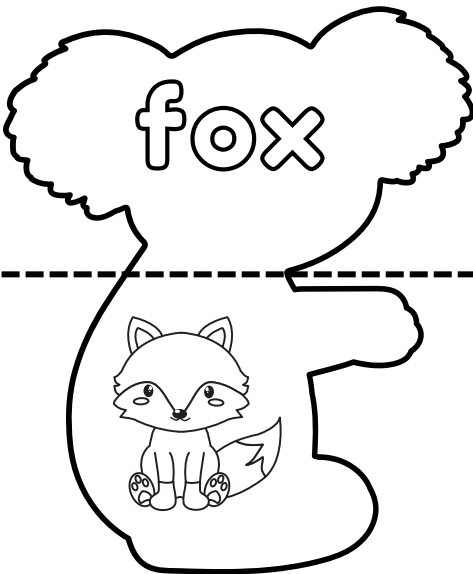
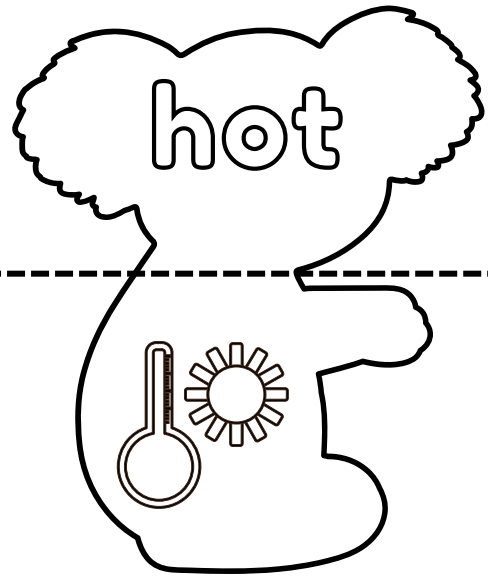
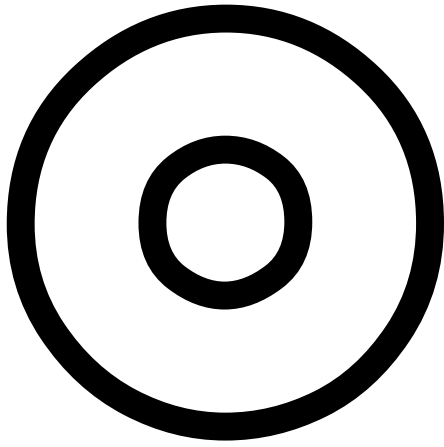

Koala CVC Words - Short u

u

