

a b c d e f g h i j k l m n o p q r s t u v w x y z

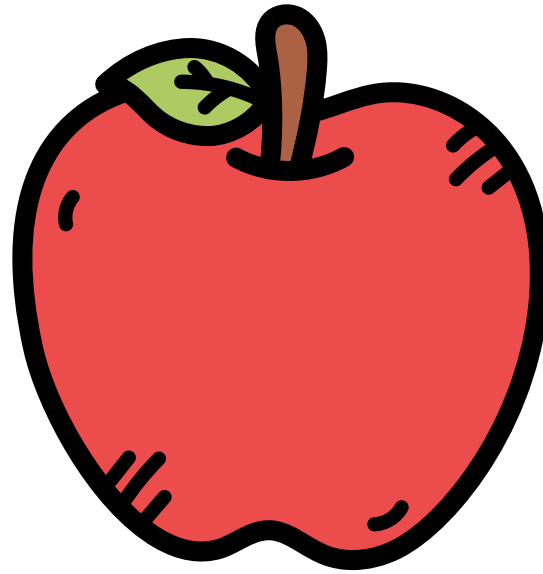

apple

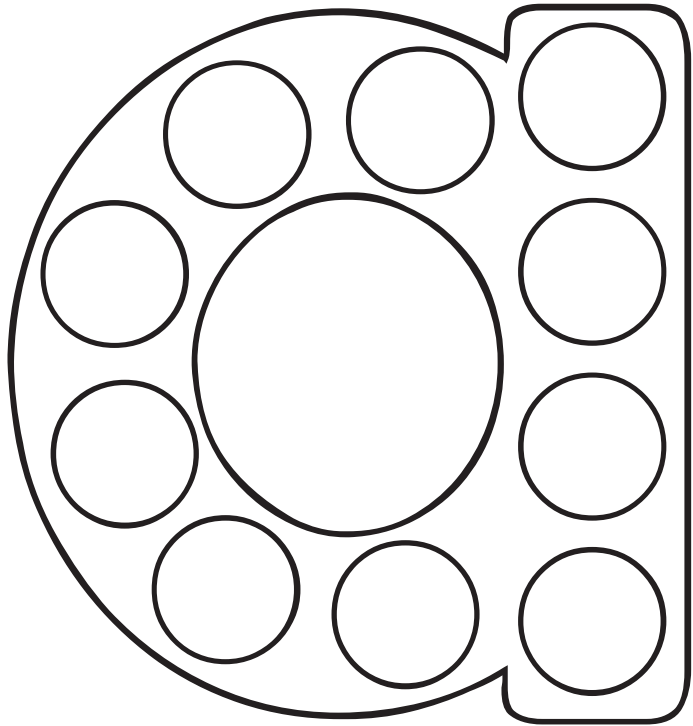
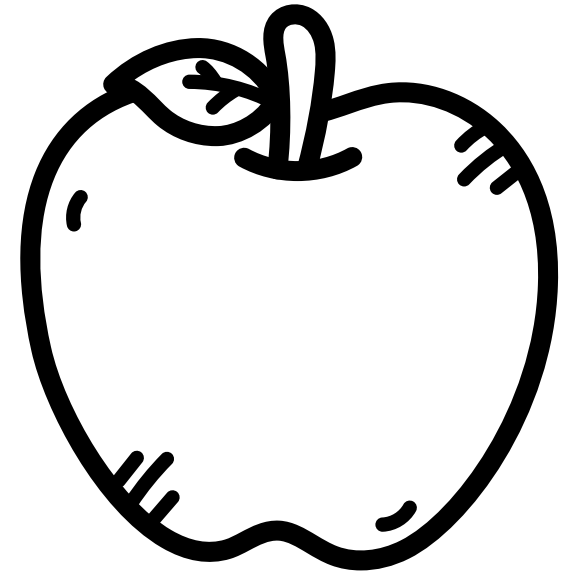

apple

a b c d e f g h i j k l m n o p q r s t u v w x y z

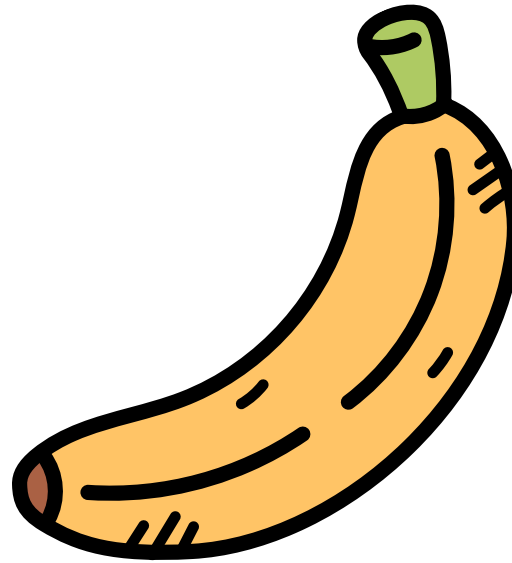
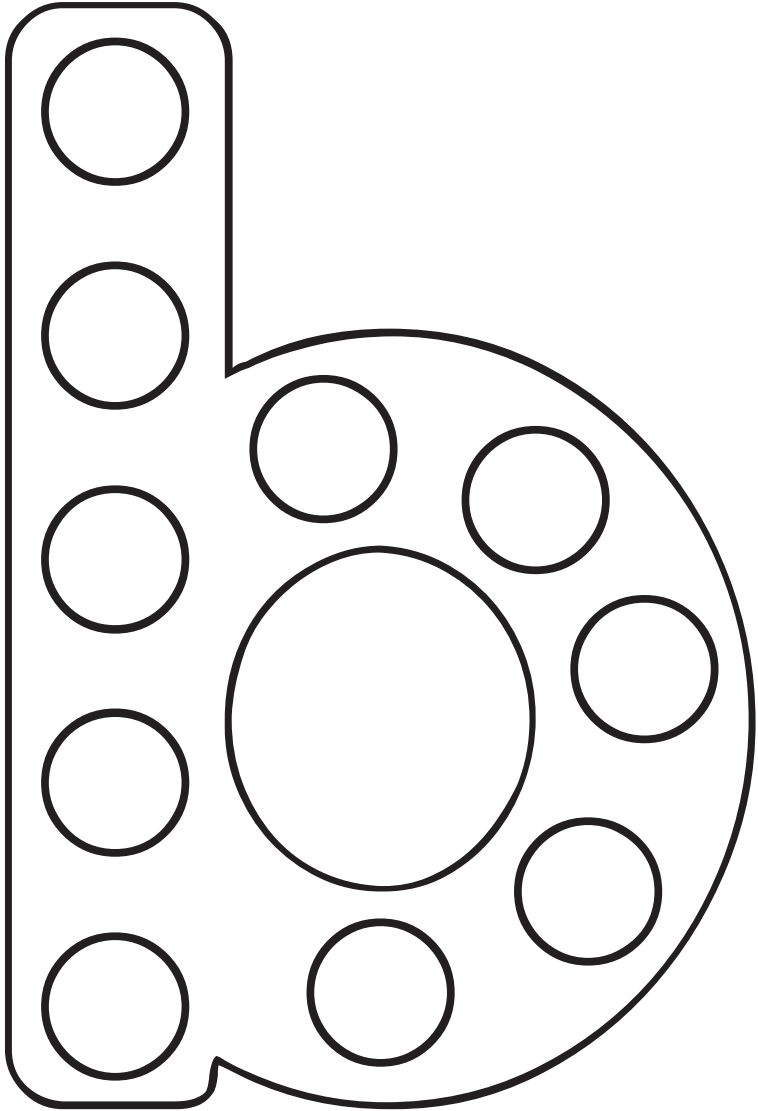

banana

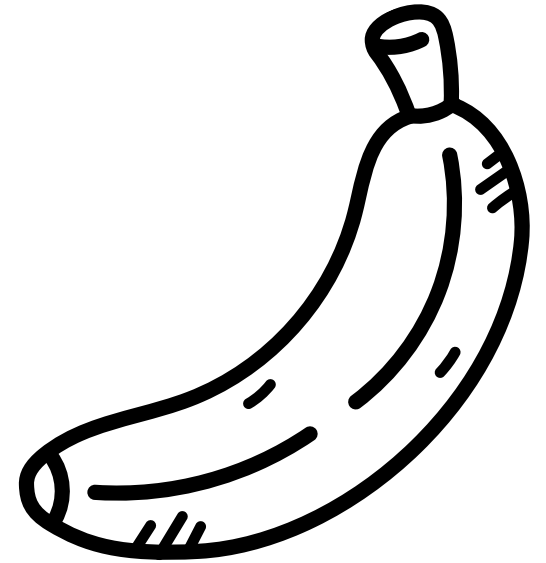

banana

a b c d e f g h i j k l m n o p q r s t u v w x y z

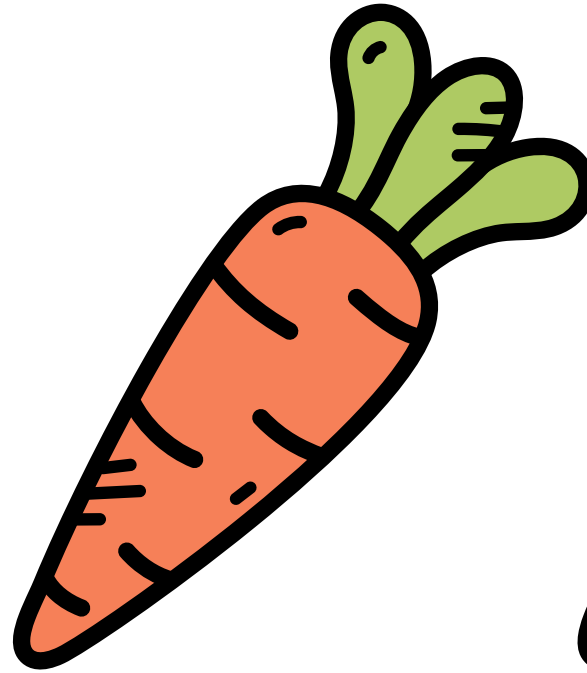
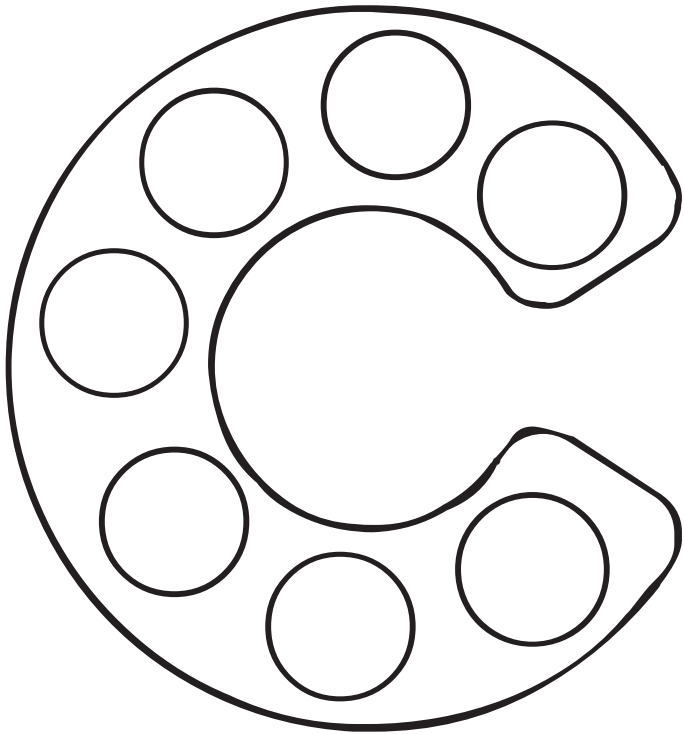

carrot

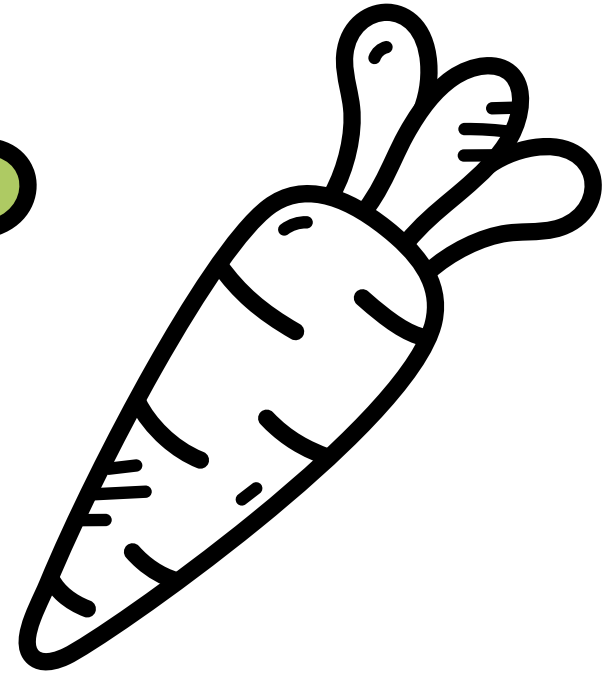

carrot

a b c d e f g h i j k l m n o p q r s t u v w x y z

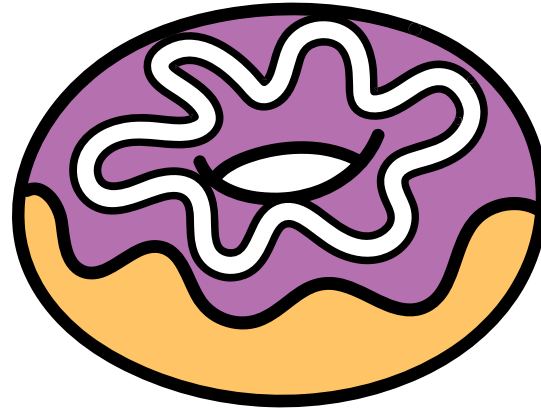
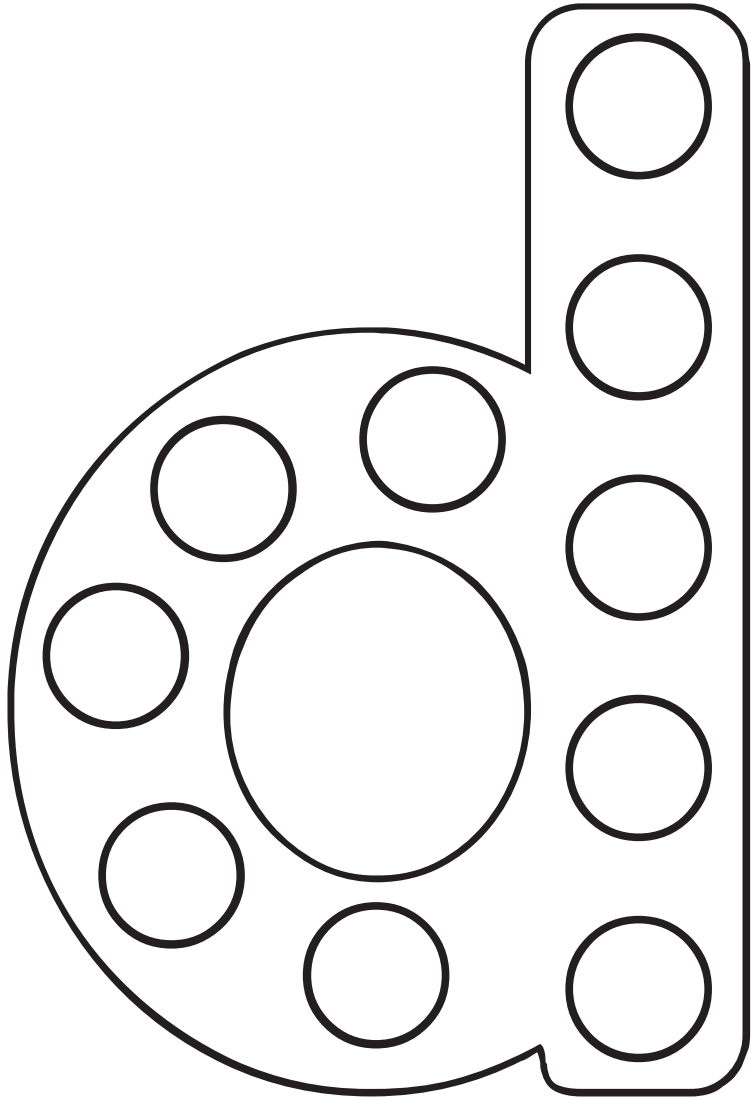

donut

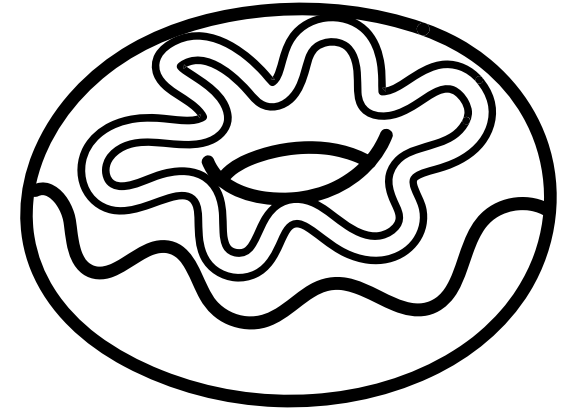

donut

a b c d e f g h i j k l m n o p q r s t u v w x y z

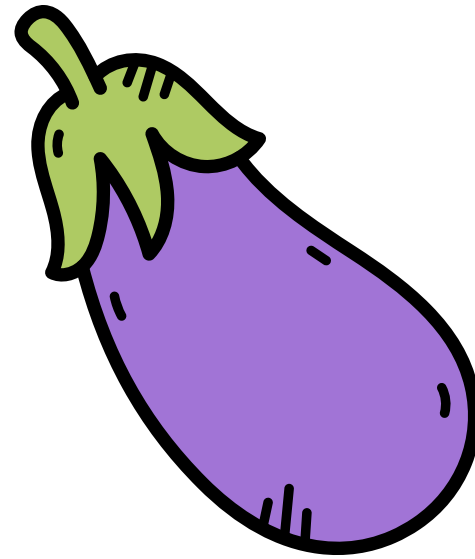
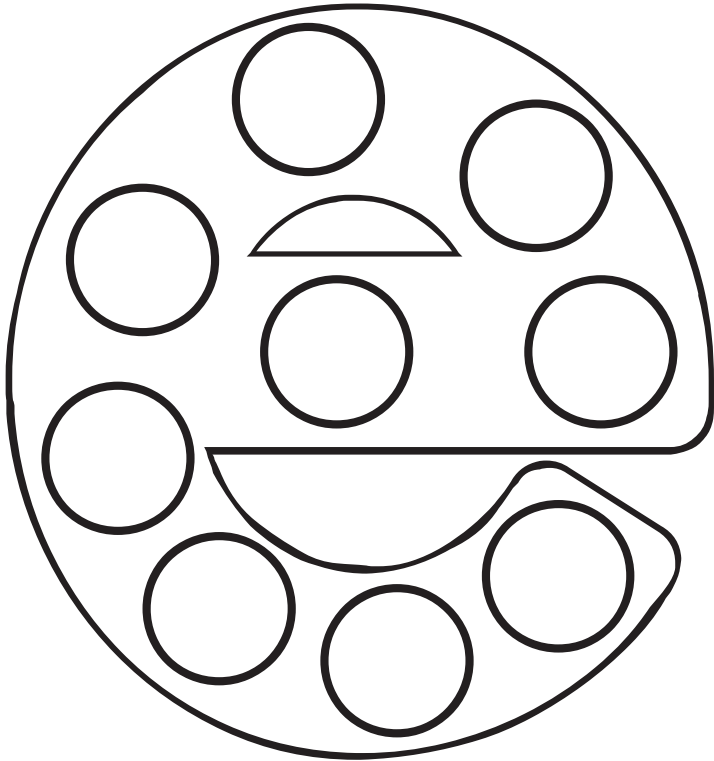

eggplant

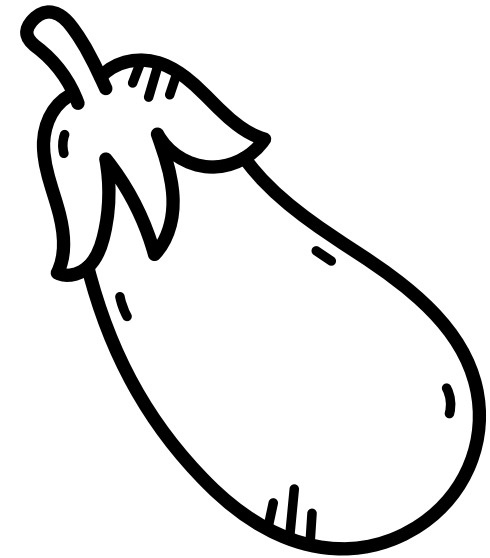

eggplant

a b c d e f g h i j k l m n o p q r s t u v w x y z

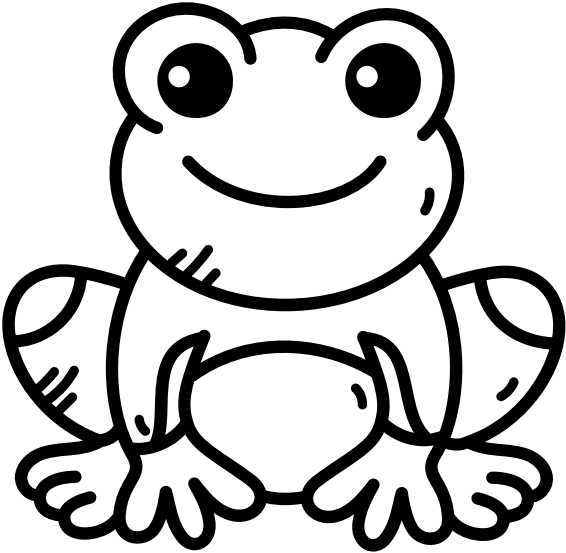
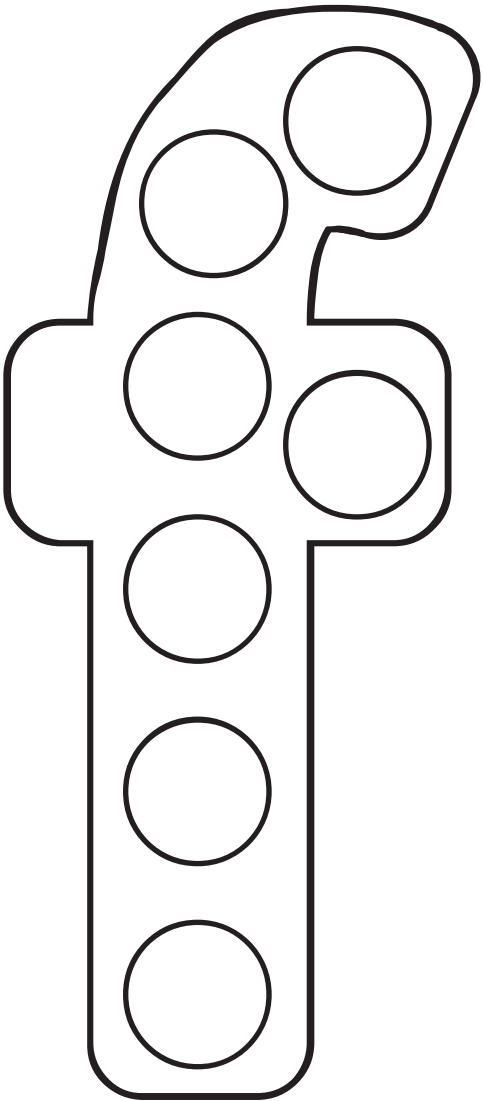

frog

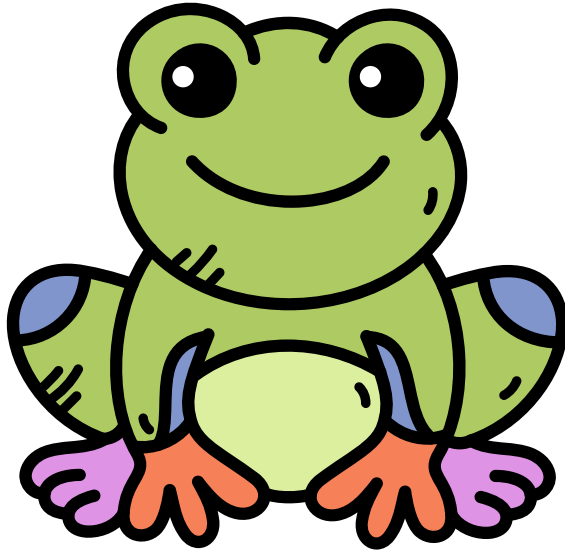

frog

a b c d e f **g** h i j k l m n o p q r s t u v w x y z

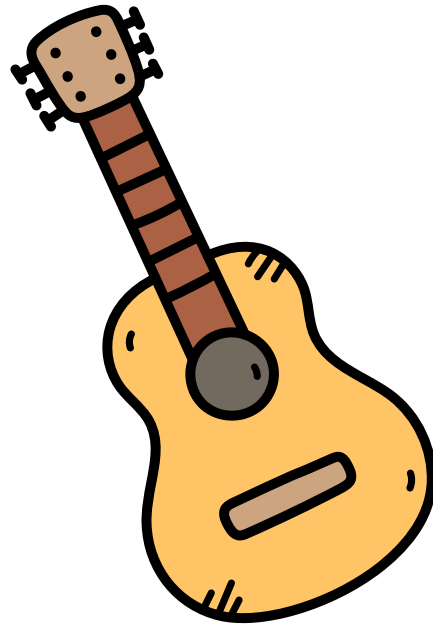
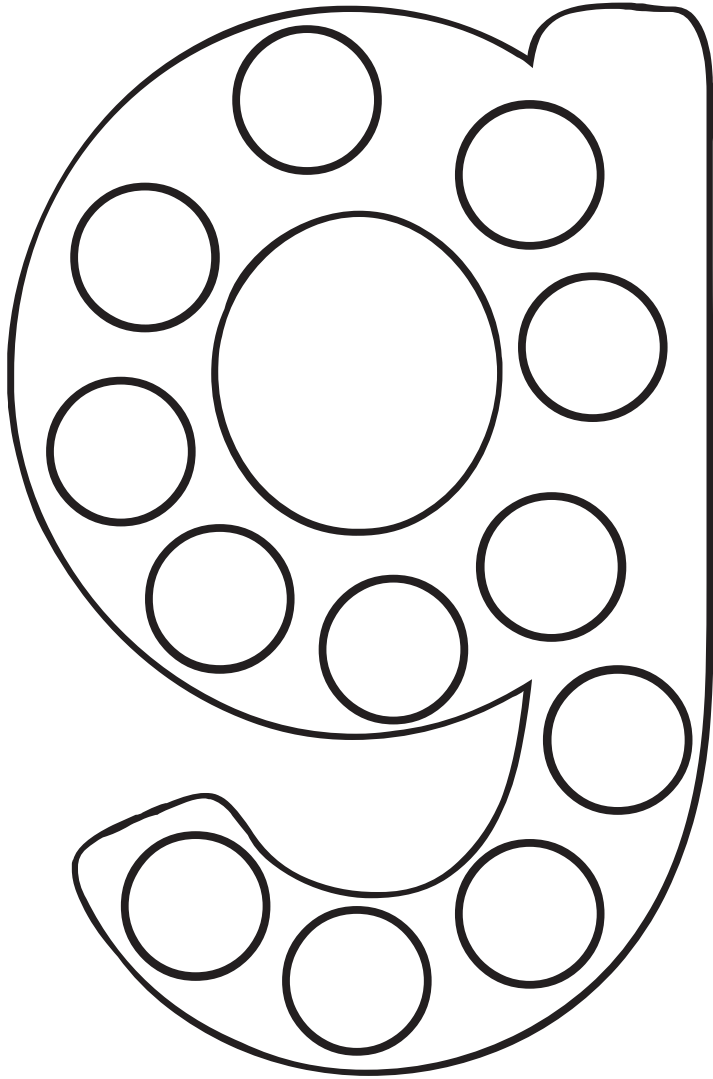

guitar

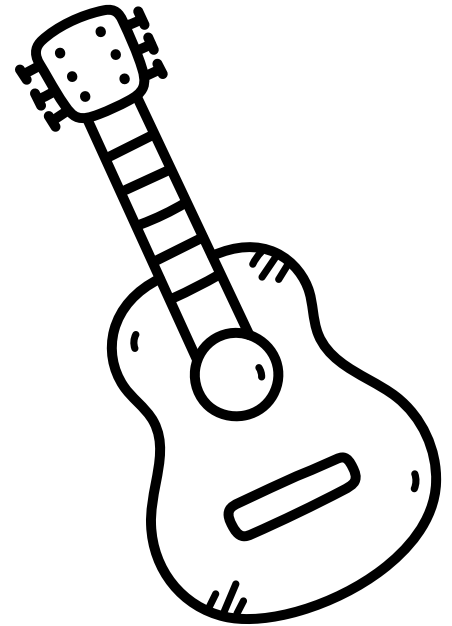

guitar

a b c d e f g h i j k l m n o p q r s t u v w x y z

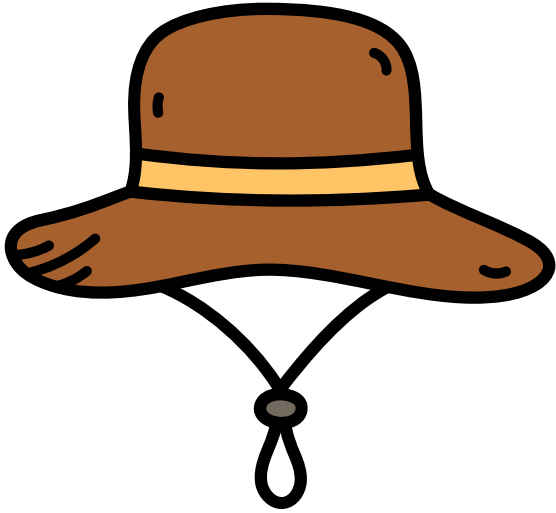
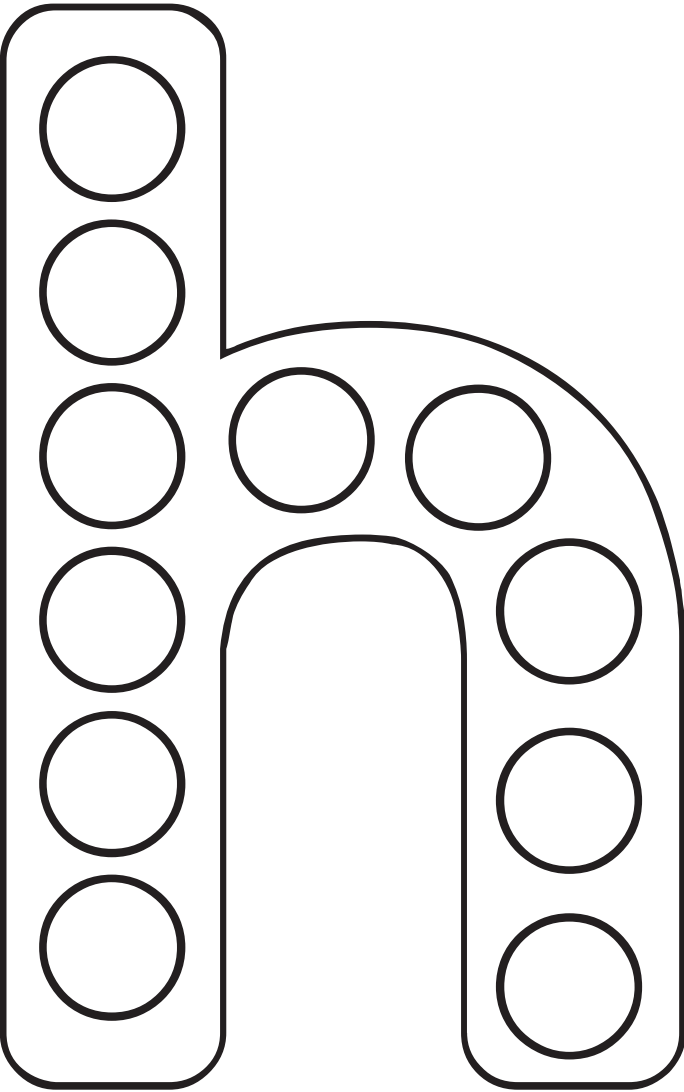

hat

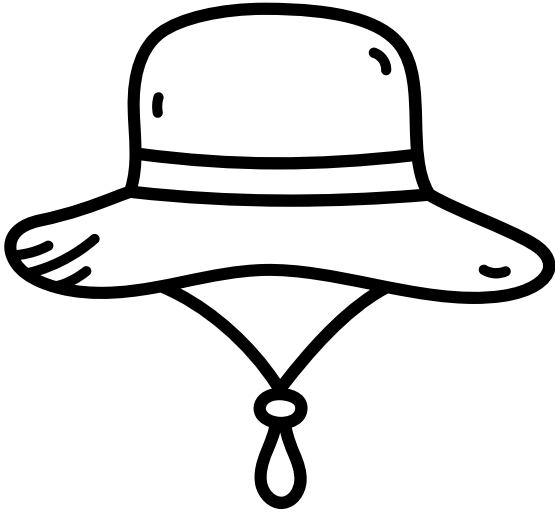

hat

a b c d e f g h i j k l m n o p q r s t u v w x y z

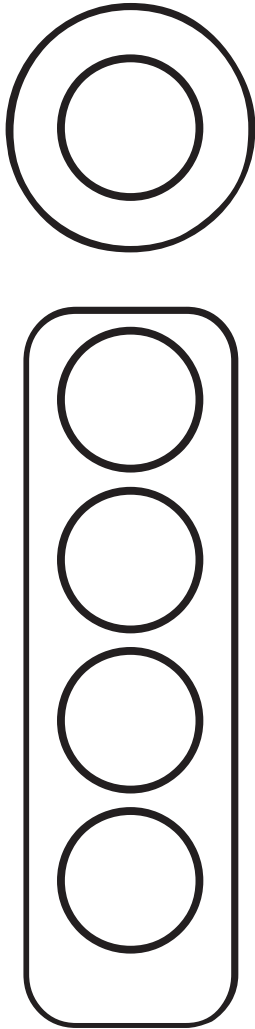

ice cream

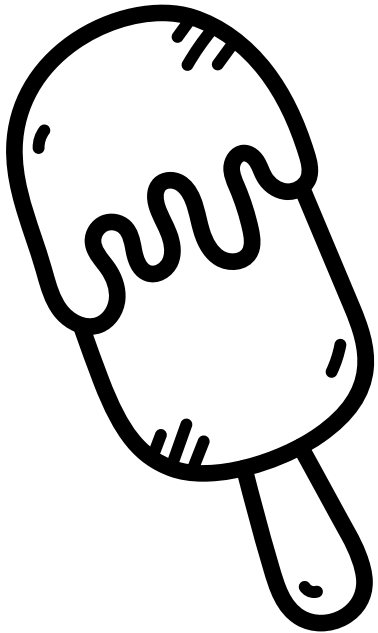

ice cream

a b c d e f g h i j k l m n o p q r s t u v w x y z

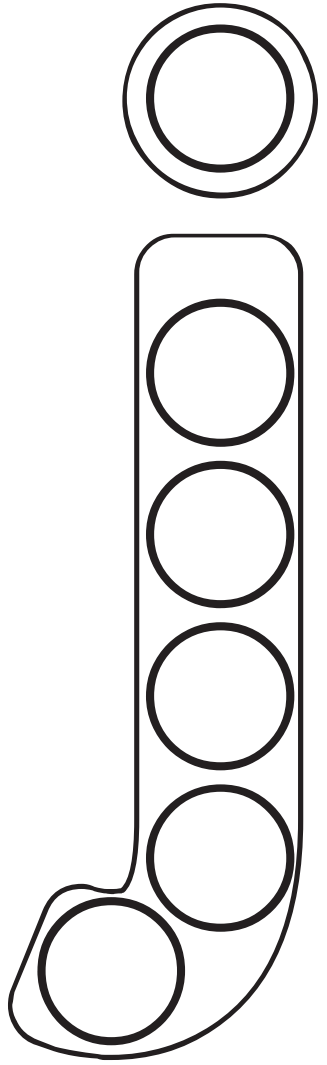

jar



jar

a b c d e f g h i j **k** l m n o p q r s t u v w x y z

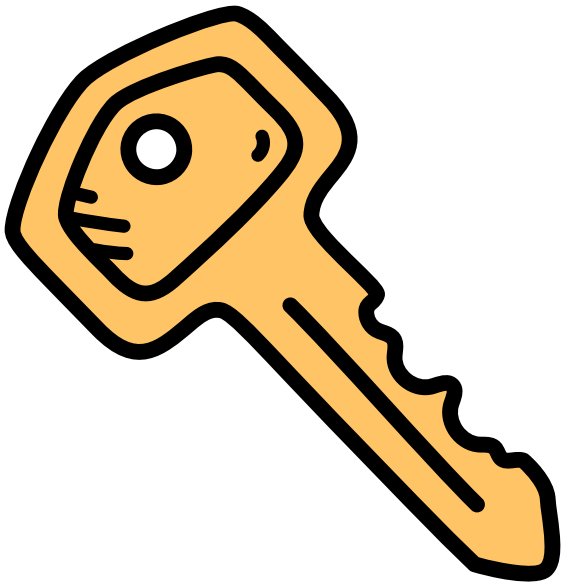
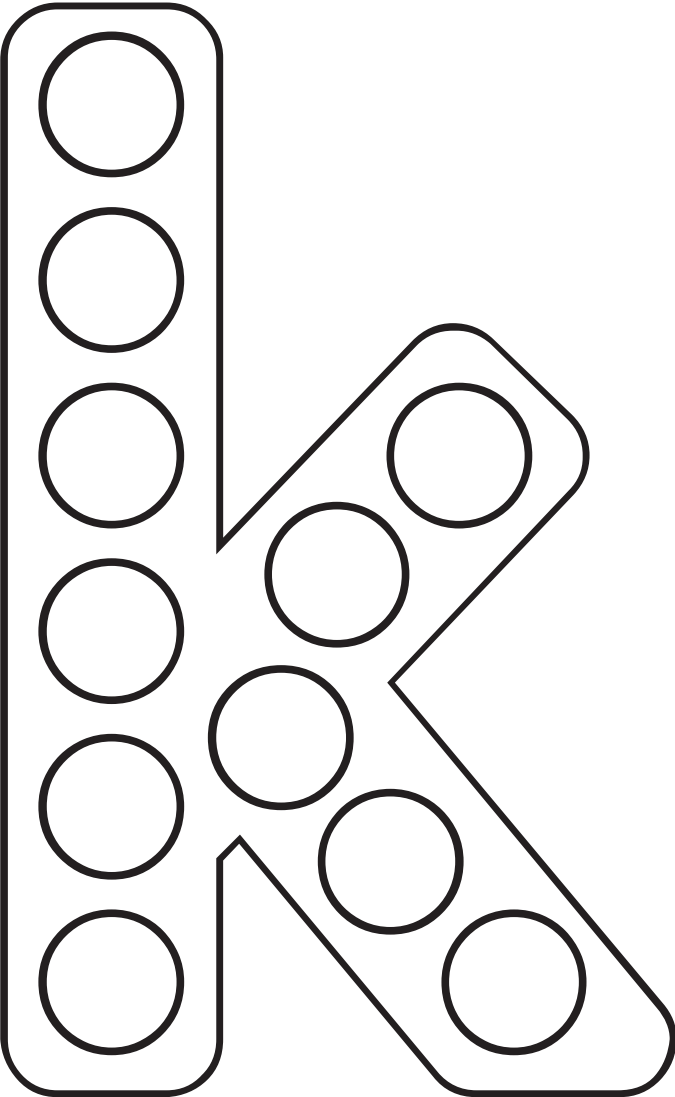

key

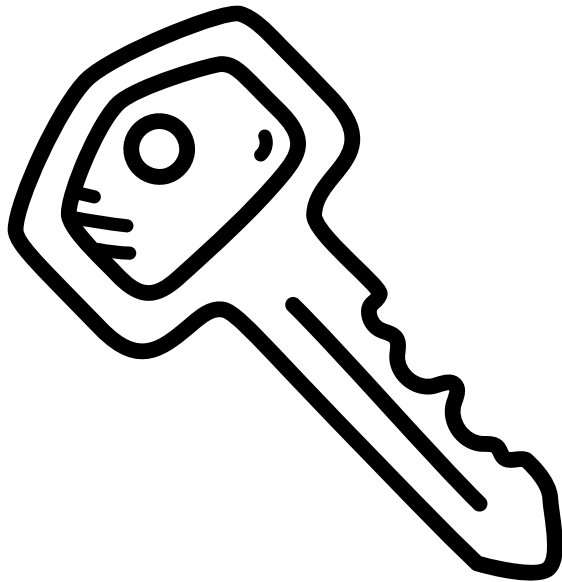

key

a b c d e f g h i j k l m n o p q r s t u v w x y z

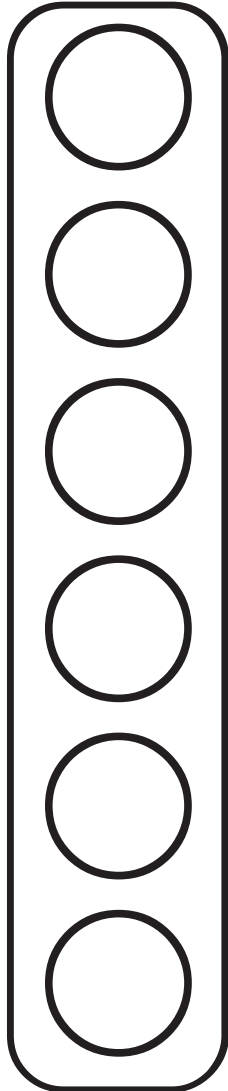

leaf

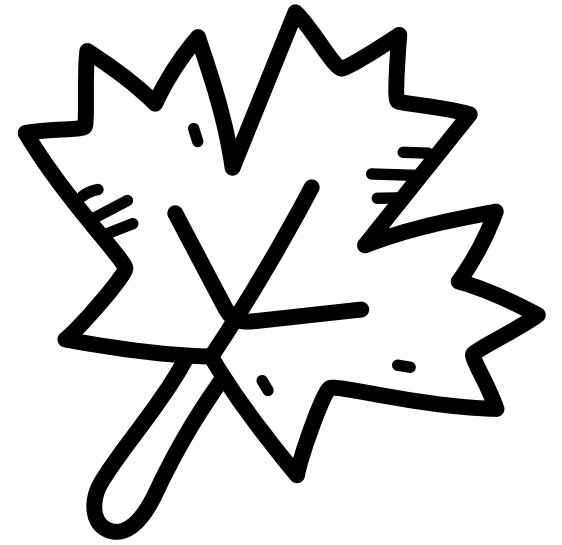

leaf

a b c d e f g h i j k l m n o p q r s t u v w x y z

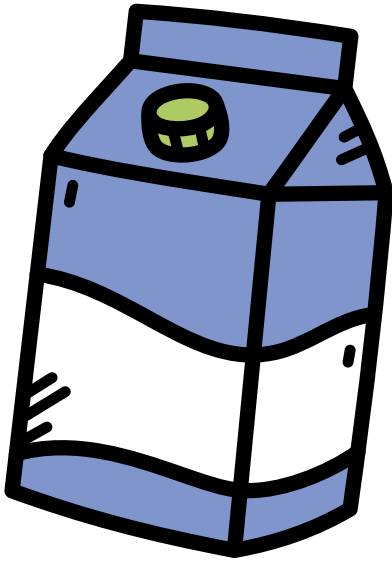
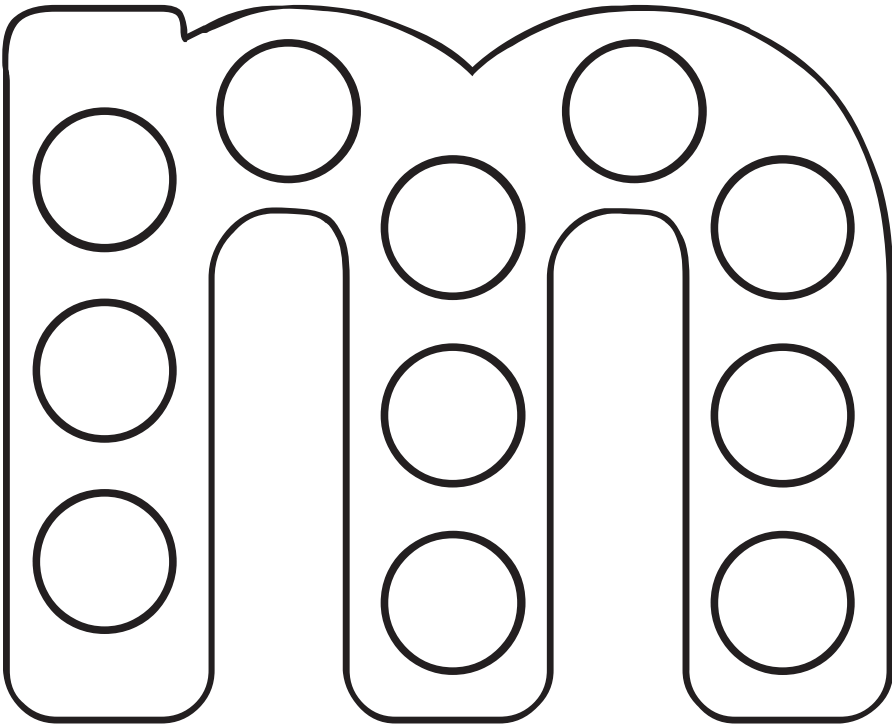

milk

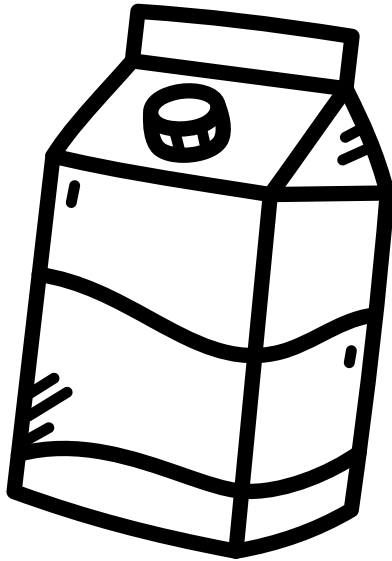

milk

a b c d e f g h i j k l m n o p q r s t u v w x y z

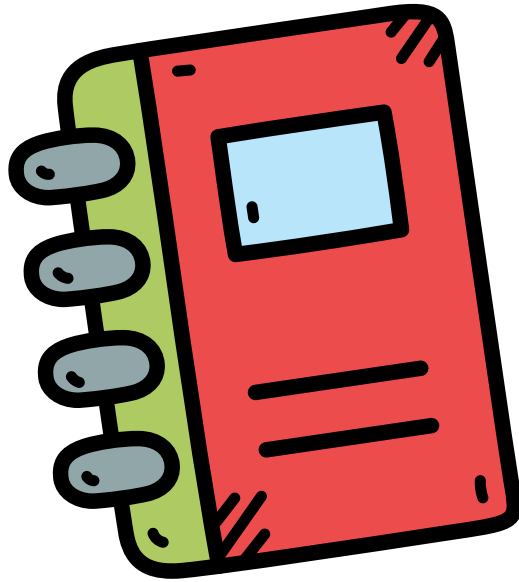
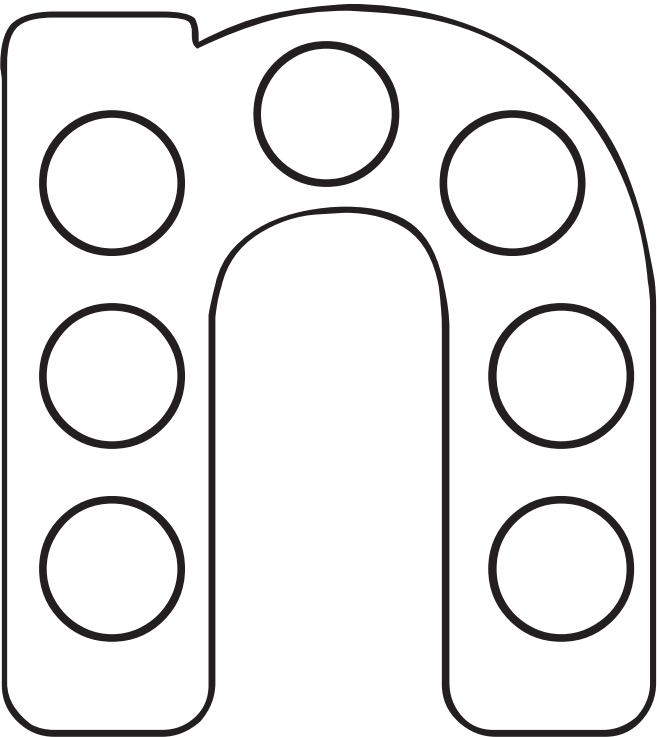

notebook

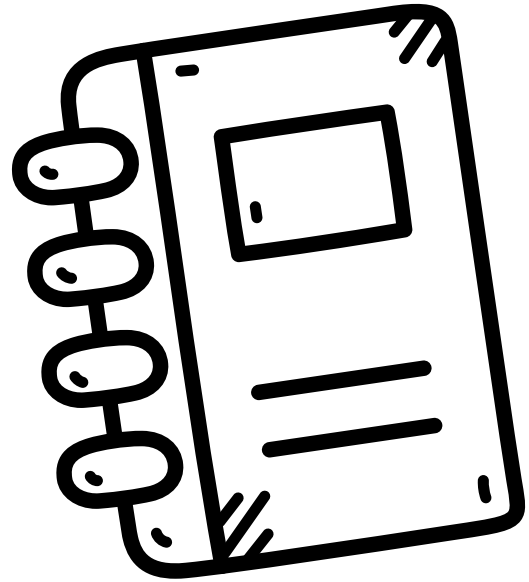

notebook

a b c d e f g h i j k l m n o p q r s t u v w x y z

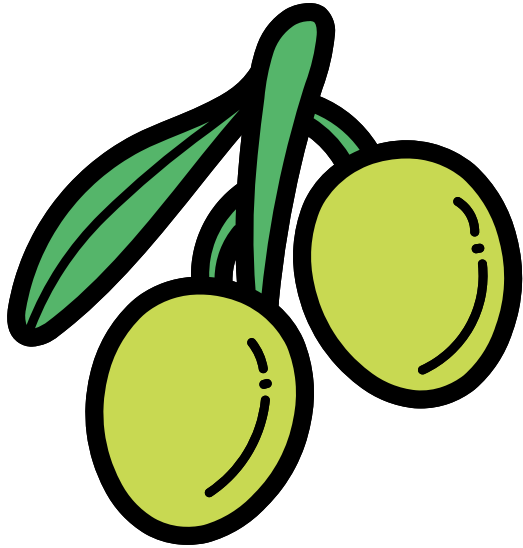
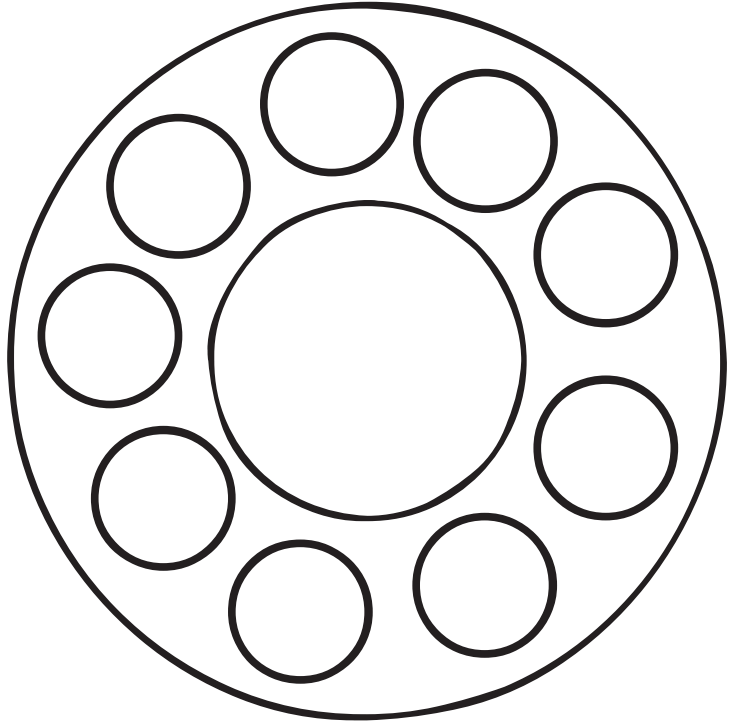

olives

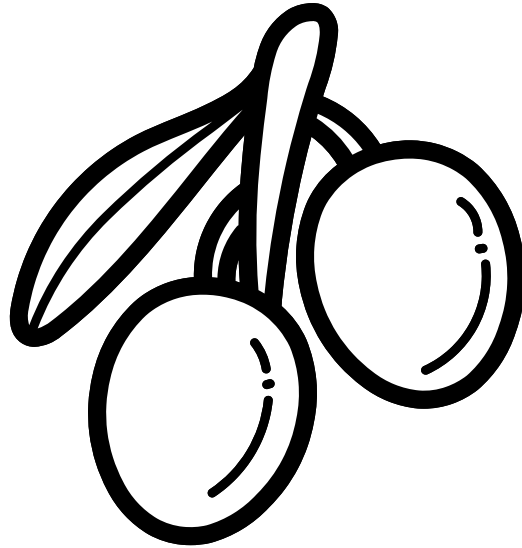

olives

a b c d e f g h i j k l m n o p q r s t u v w x y z

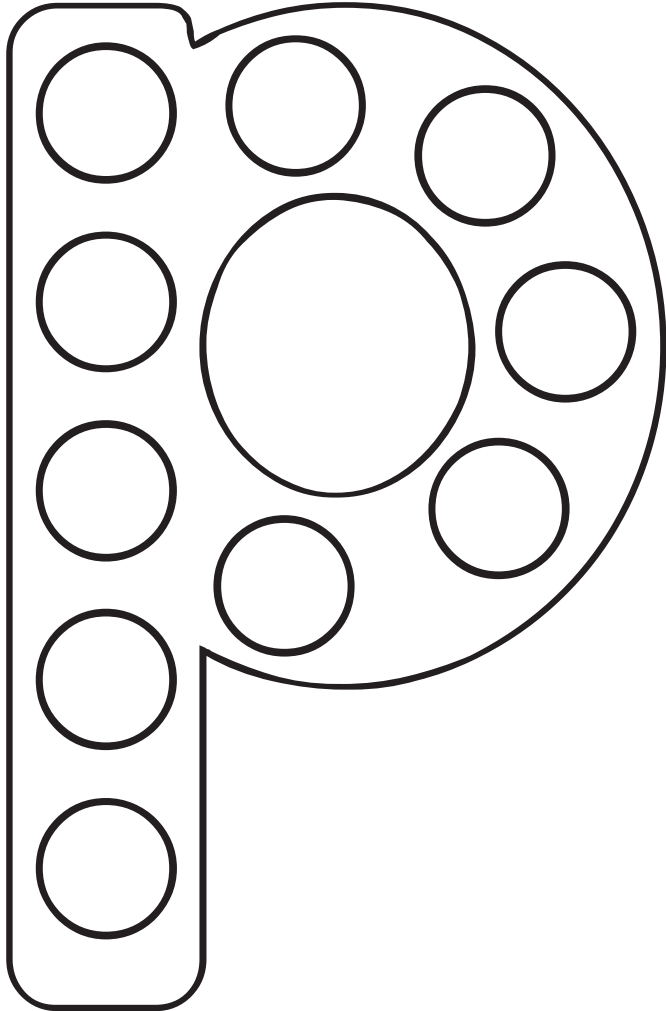

pumpkin

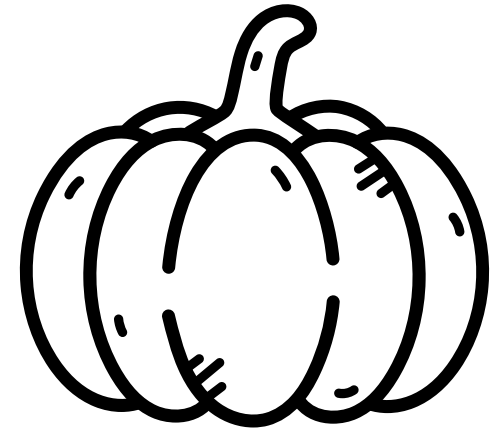

pumpkin

a b c d e f g h i j k l m n o p **q** r s t u v w x y z

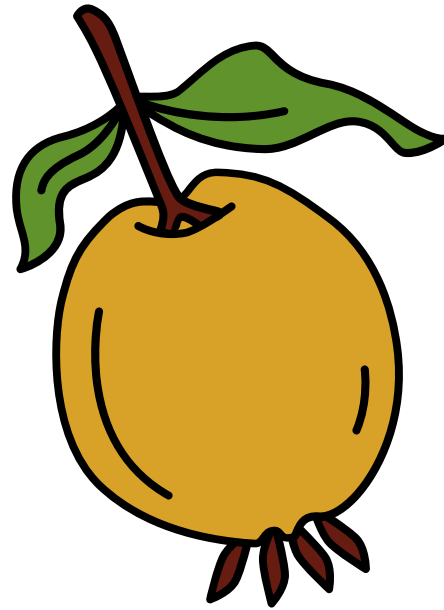
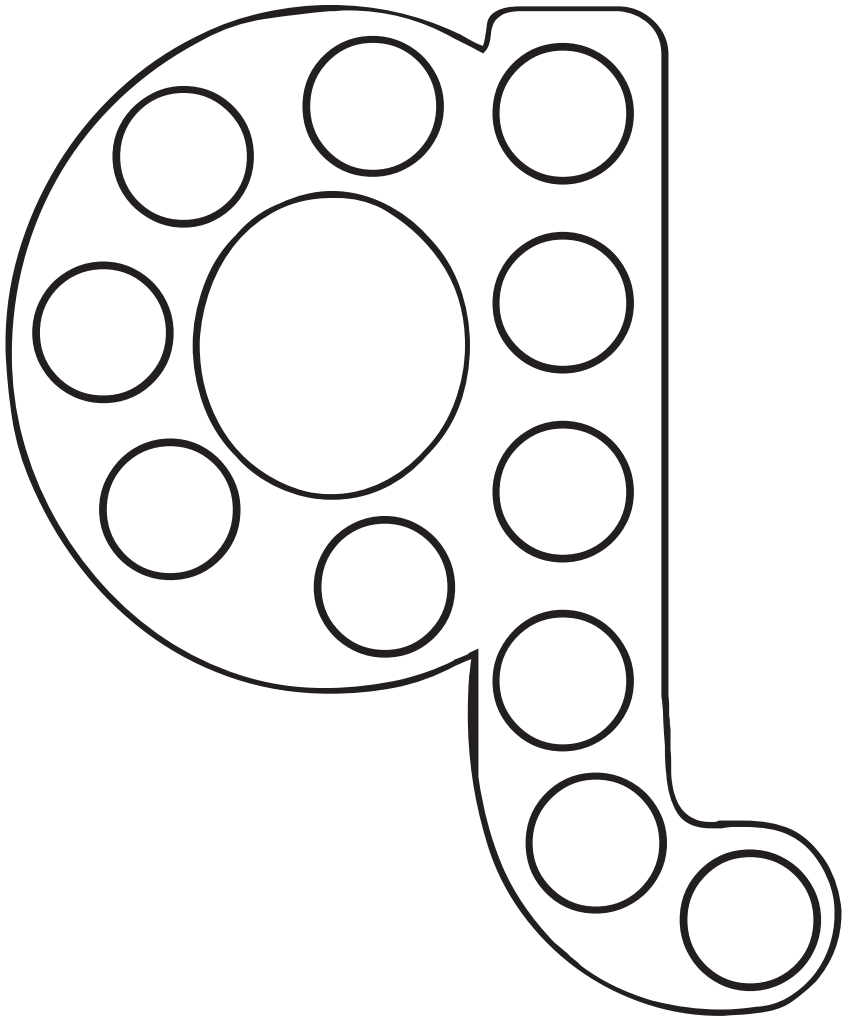

quince

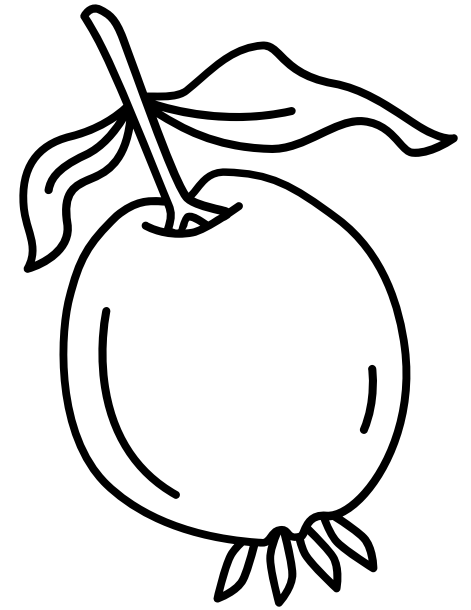

quince

a b c d e f g h i j k l m n o p q r s t u v w x y z

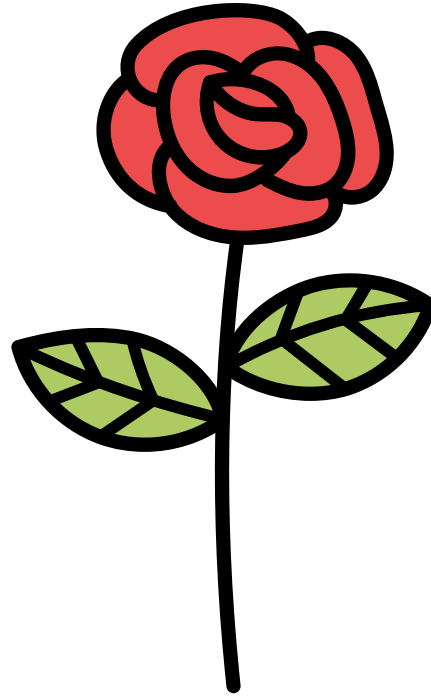
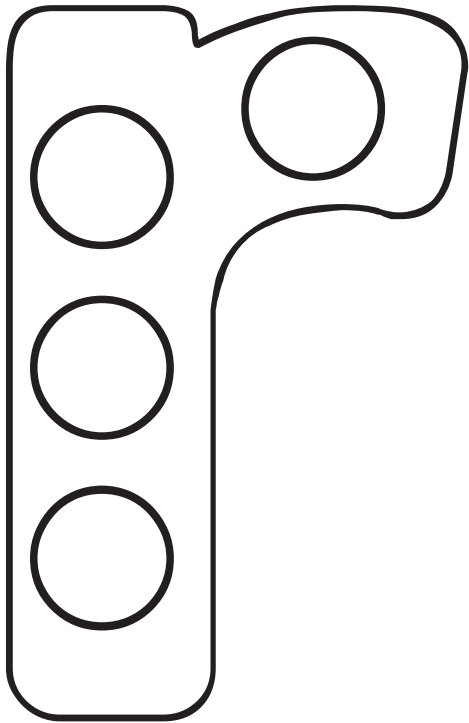

rose

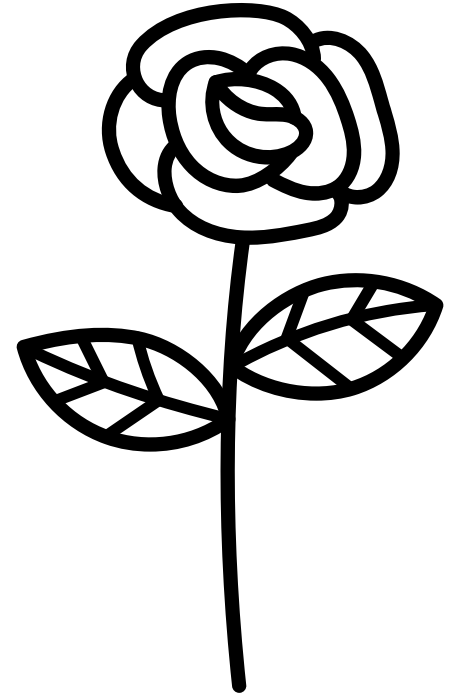

rose

a b c d e f g h i j k l m n o p q r s t u v w x y z

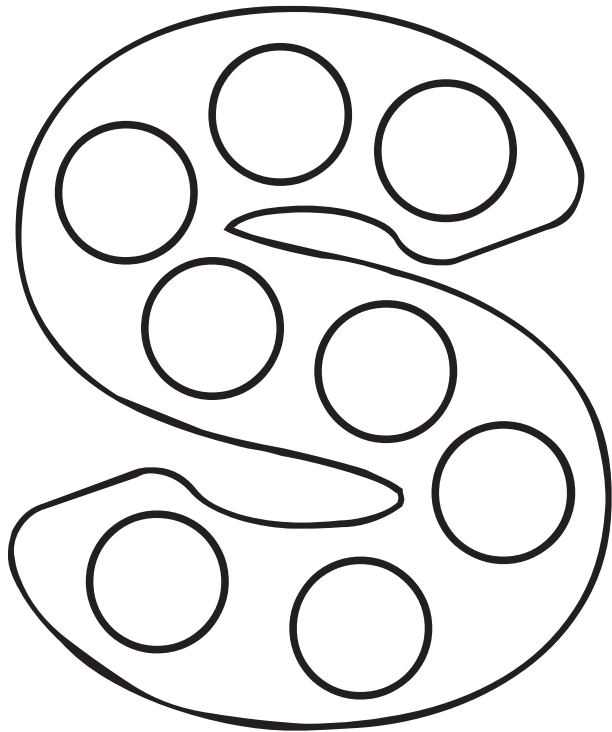

scarf

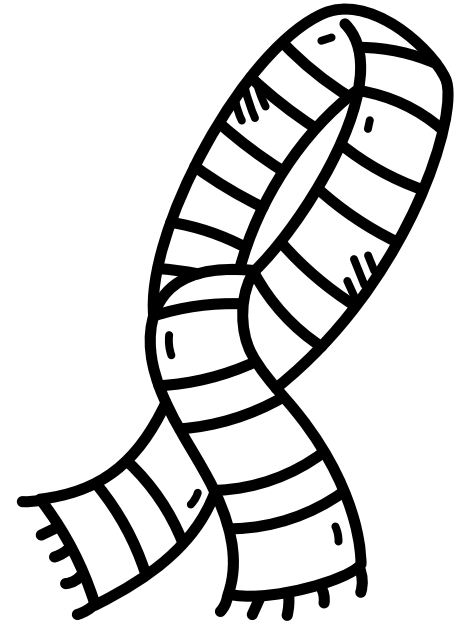

scarf

a b c d e f g h i j k l m n o p q r s t u v w x y z

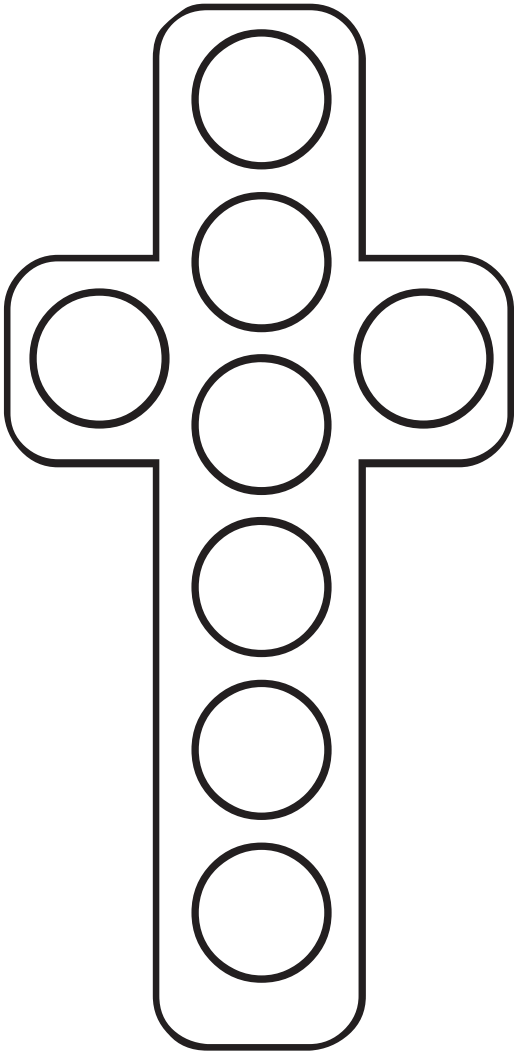

tree

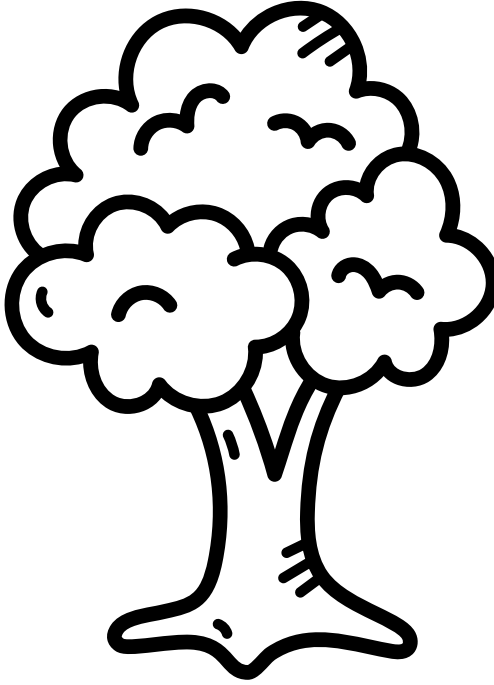

tree

a b c d e f g h i j k l m n o p q r s t u v w x y z

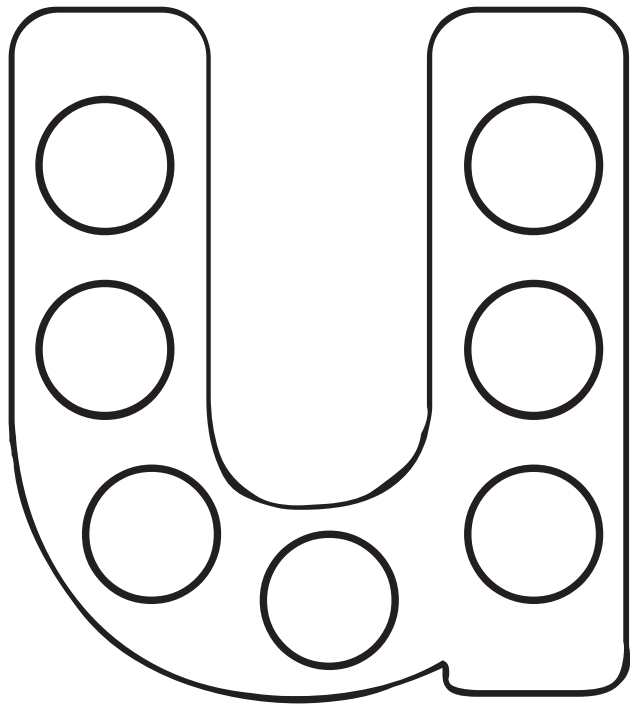

umbrella



umbrella

a b c d e f g h i j k l m n o p q r s t u v w x y z

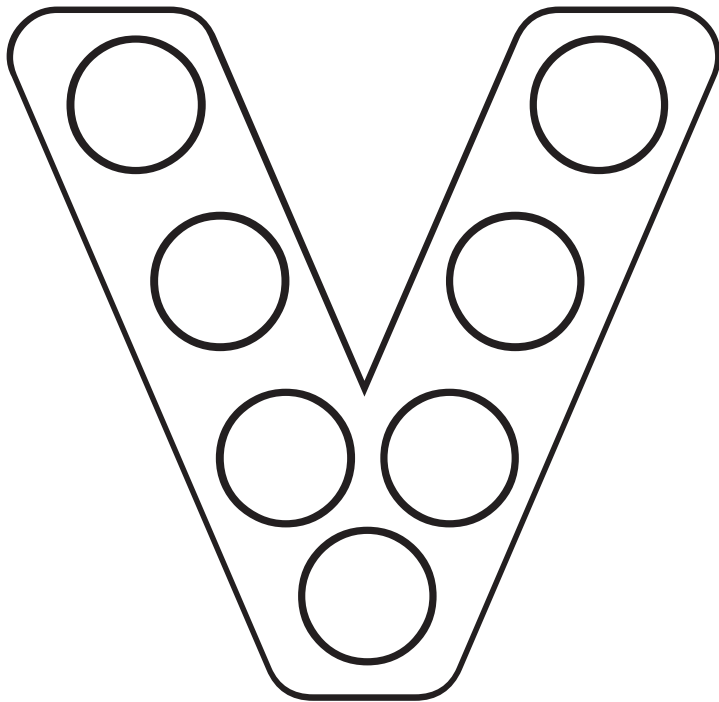

vest



vest

a b c d e f g h i j k l m n o p q r s t u v w x y z

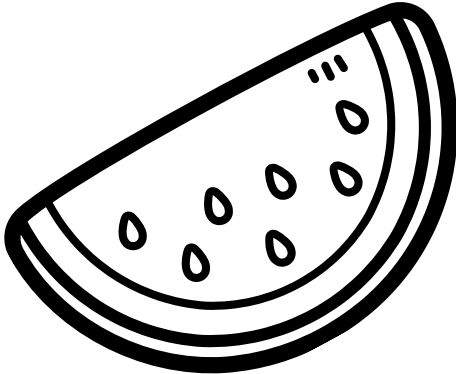
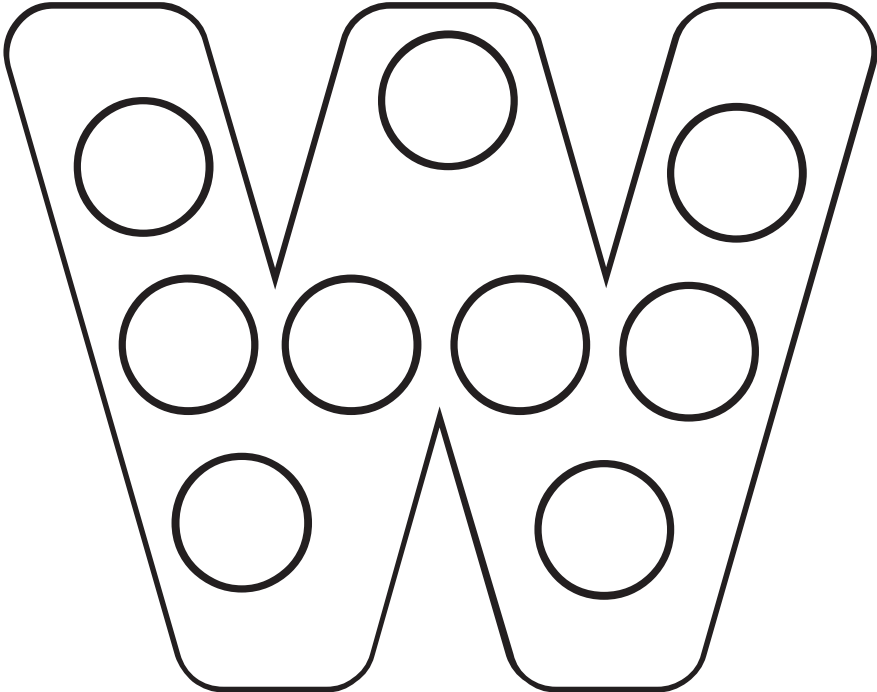

watermelon

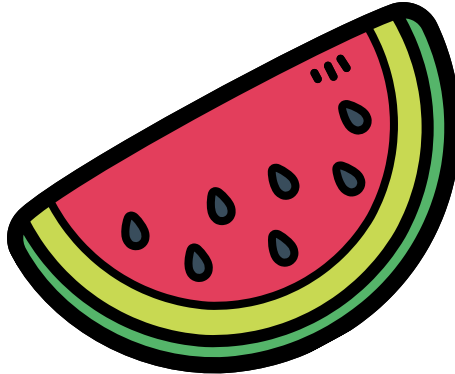

watermelon

a b c d e f g h i j k l m n o p q r s t u v w x y z

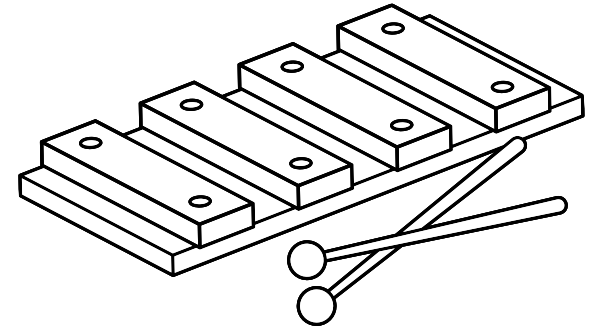
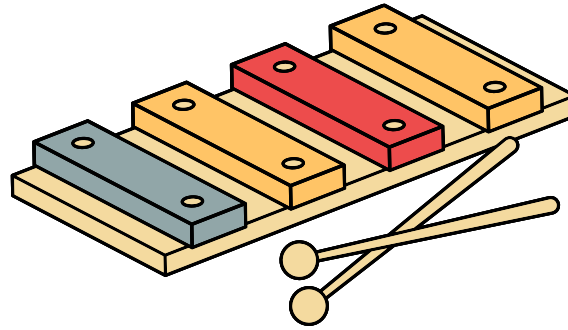
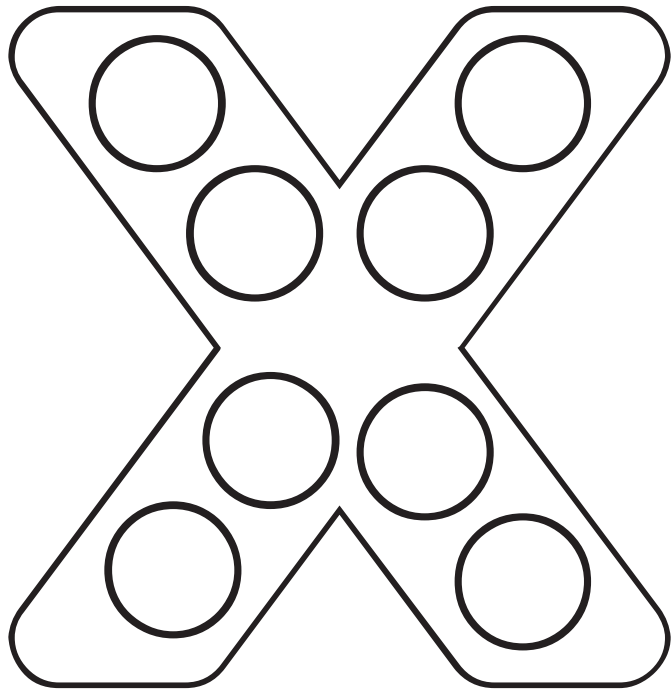

xylophone

xylophone

a b c d e f g h i j k l m n o p q r s t u v w x **y** z

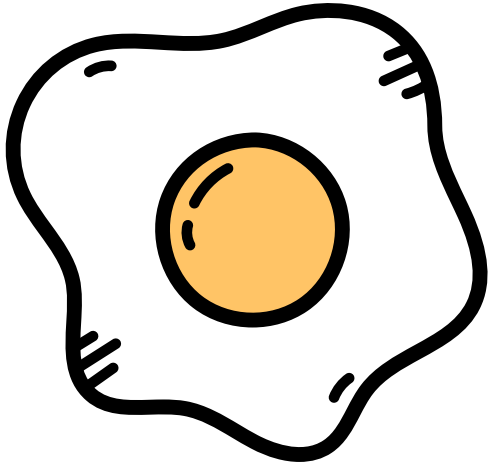
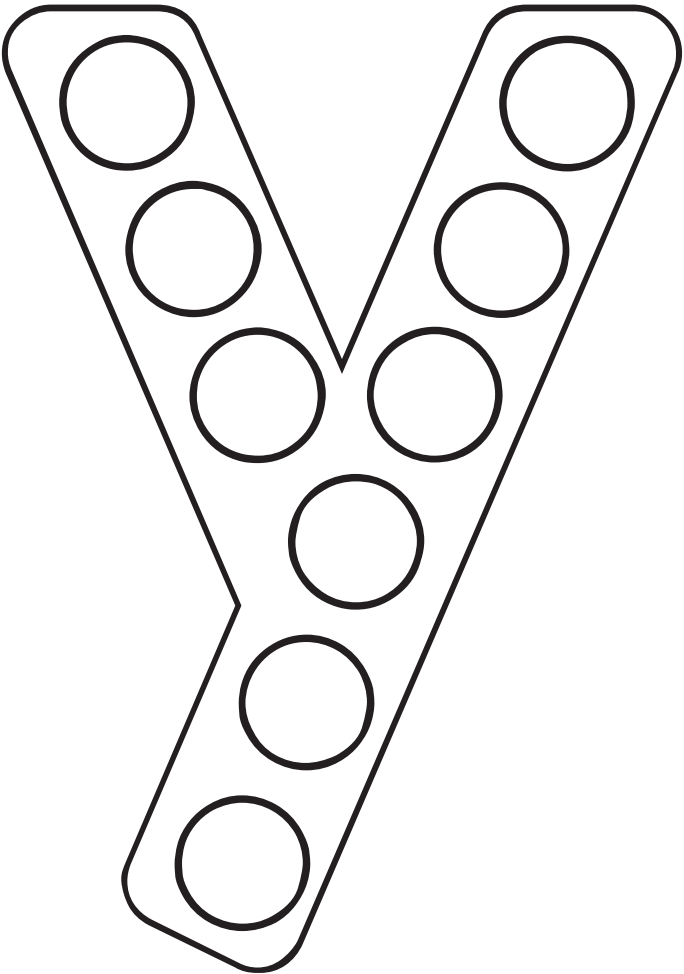

yolk

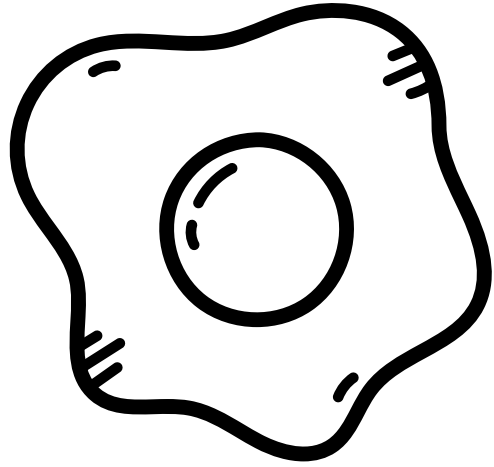

yolk

a b c d e f g h i j k l m n o p q r s t u v w x y z

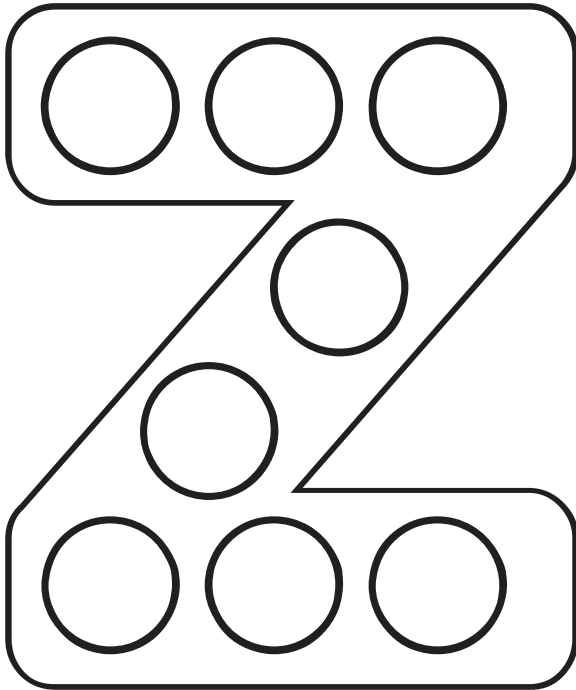

zipper

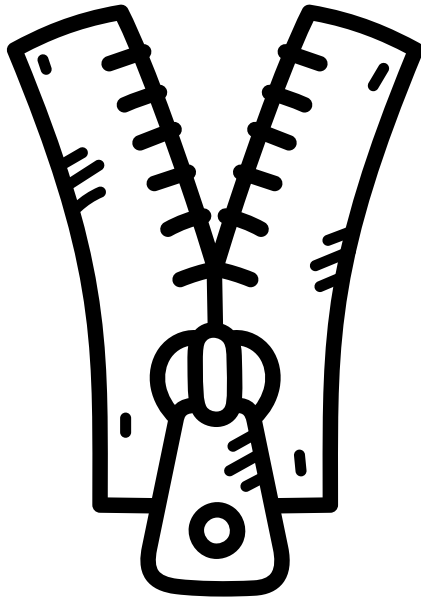

zipper