

WRITING LETTERS

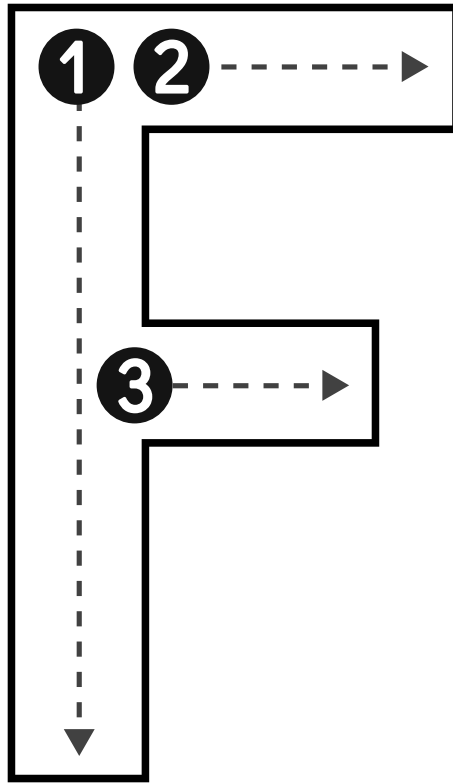

F F F F F

Handwriting practice lines consisting of two sets of four horizontal lines each. Each set includes a solid top line, a dashed middle line, and a solid bottom line.

WRITING LETTERS

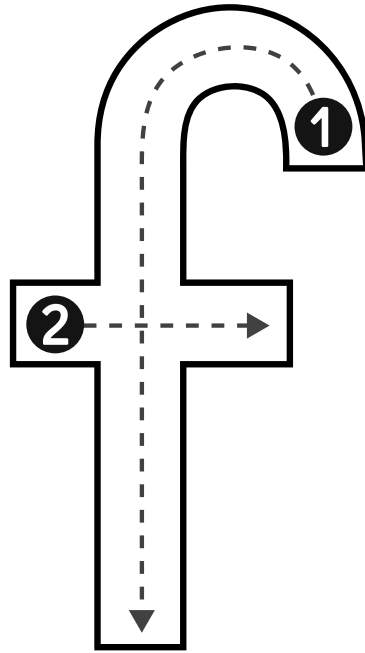

f f f f f

Handwriting practice lines consisting of two sets of three horizontal lines (top solid, middle dashed, bottom solid).

Uppercase F Tracing Practice

F

Tracing practice area consisting of 15 rows of handwriting lines. Each row contains 10 boxes. The first box in each row contains a solid uppercase letter 'F' for tracing. The remaining 9 boxes in each row are empty for independent practice. Each box is defined by a solid top line, a dashed middle line, and a solid bottom line.

Lowercase f Tracing Practice

f f f f f f f f f f f f f f f f

f f f f f f f f f f f f f f f f

f f f f f f f f f f f f f f f f

f f f f f f f f f f f f f f f f

f f f f f f f f f f f f f f f f

f f f f f f f f f f f f f f f f

f f f f f f f f f f f f f f f f

f f f f f f f f f f f f f f f f

f f f f f f f f f f f f f f f f

f f f f f f f f f f f f f f f f

f f f f f f f f f f f f f f f f

f f f f f f f f f f f f f f f f

f f f f f f f f f f f f f f f f

f f f f f f f f f f f f f f f f

f f f f f f f f f f f f f f f f

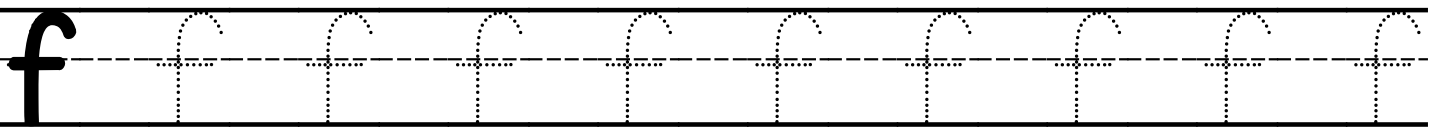
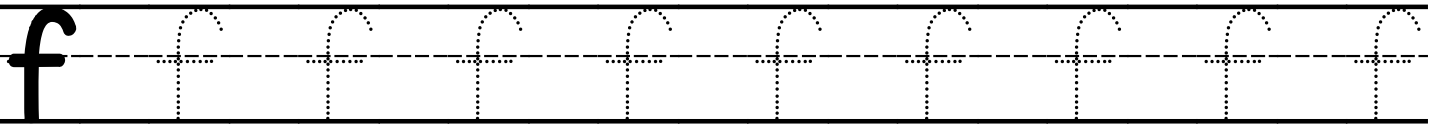
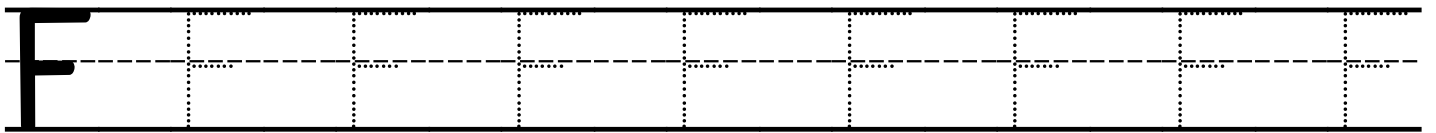
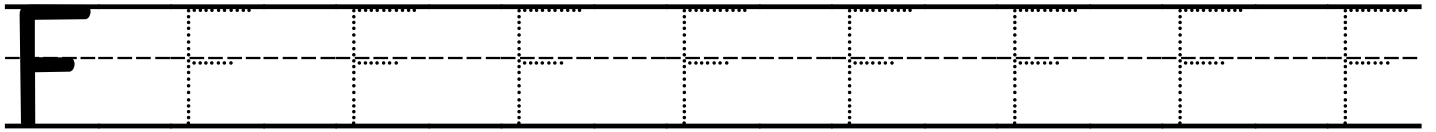
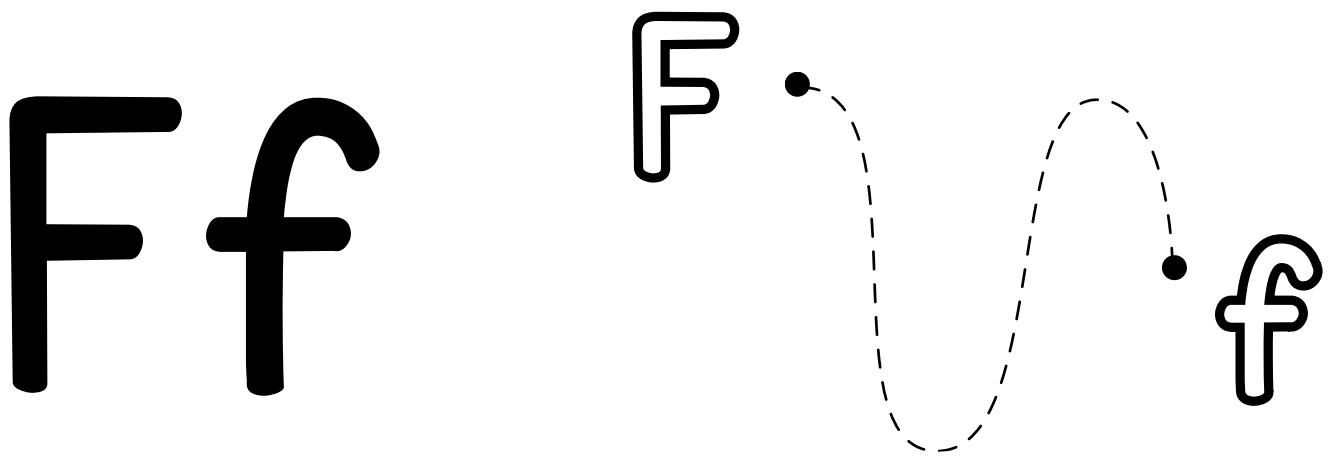

Find the letter Ff.

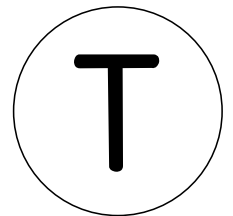
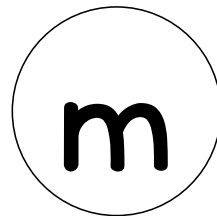
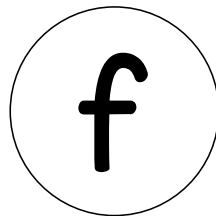
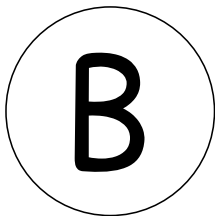
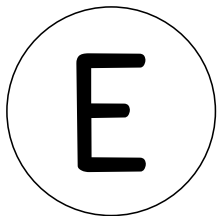
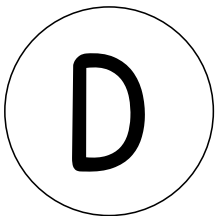
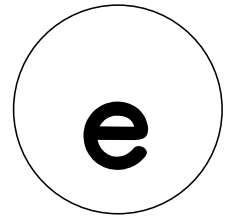
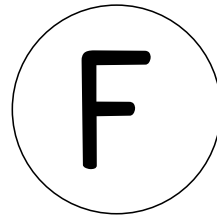
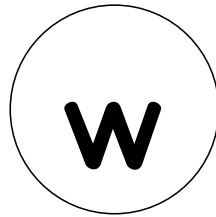
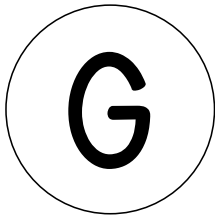
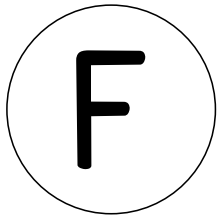
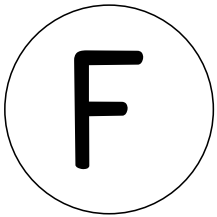
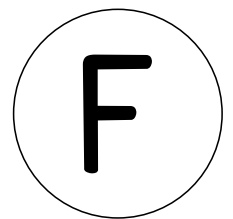
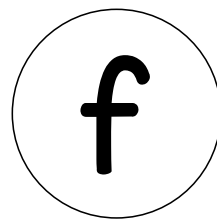
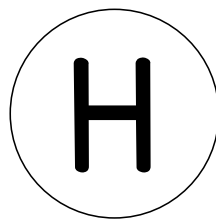
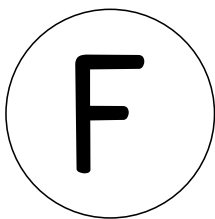
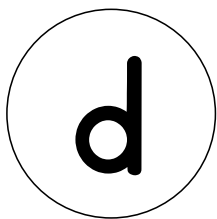
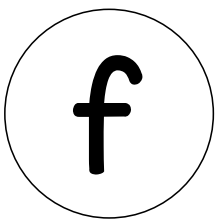

Trace the route from letter to letter.

F

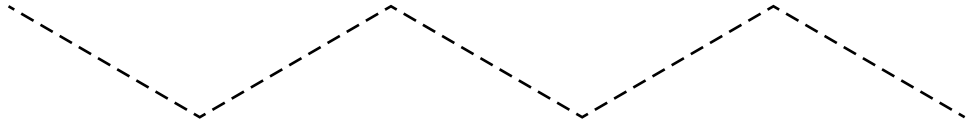

f

f

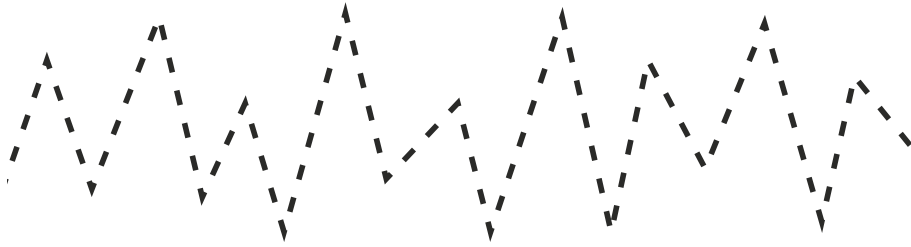

F

F

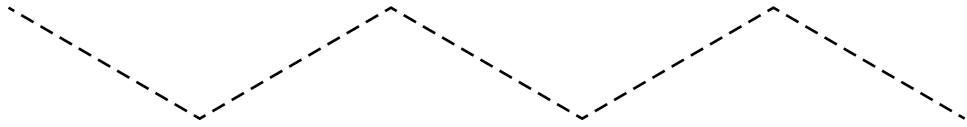

f

f

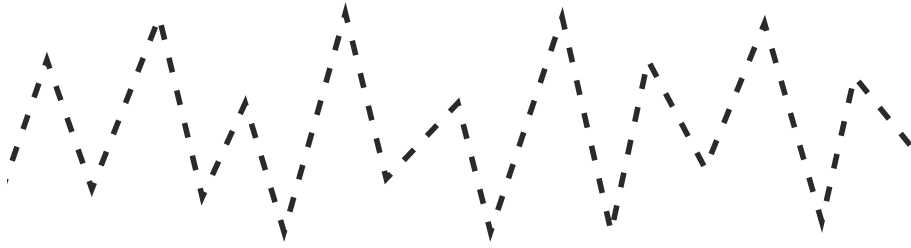

F

F

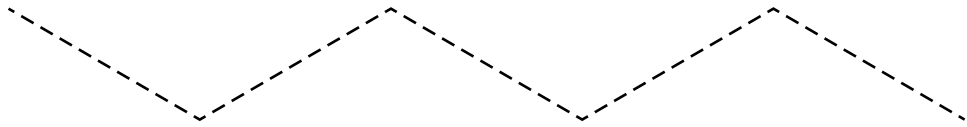

f

f

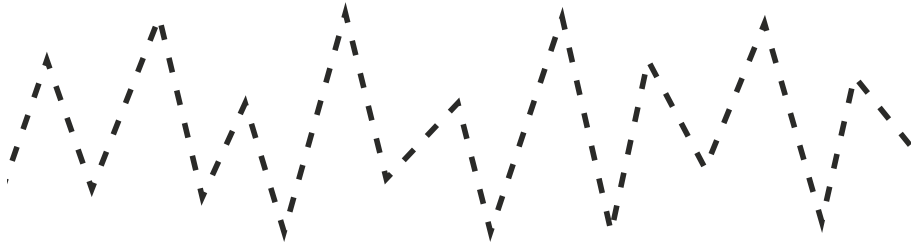

F

F

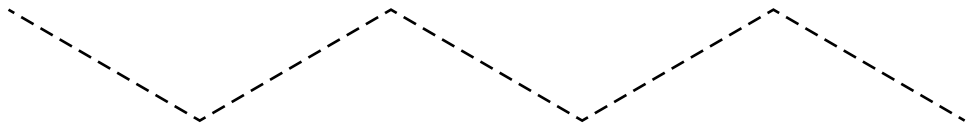

f

f

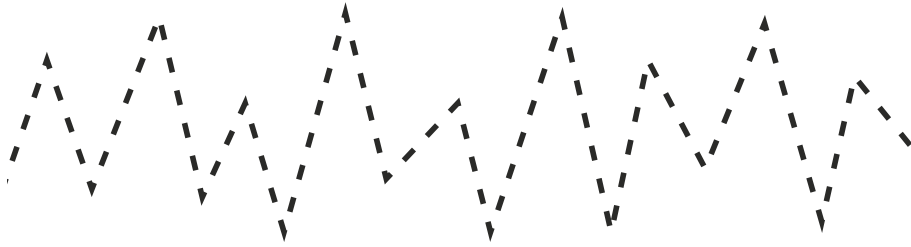

F

Letter F Uppercase Maze

F	f	f	f	f	f
F	F	F	f	f	f
f	f	F	F	f	f
f	f	f	F	F	f
f	f	f	f	F	f
f	f	f	f	F	F



Letter f Lowercase Maze

f	f	f	f	F	F
F	F	F	f	f	f
F	F	F	F	F	f
f	f	f	f	f	f
f	f	F	F	F	F
F	f	f	f	f	f

Letters Tracing Bundle

F	F	F	F
F	F	F	F
F	F	F	F
f	f	f	f
f	f	f	f
f	f	f	f

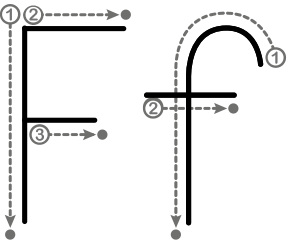
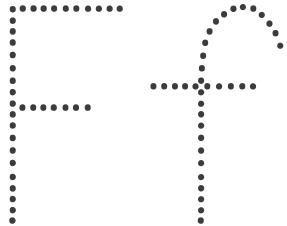
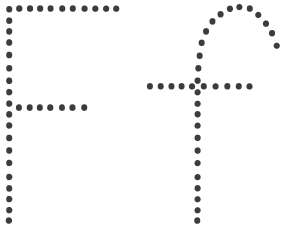
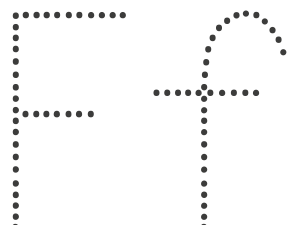
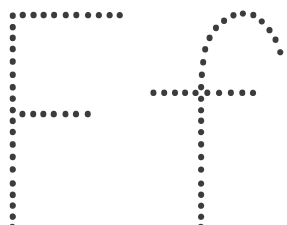
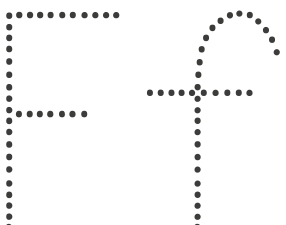
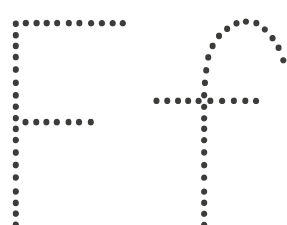
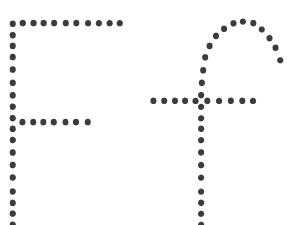
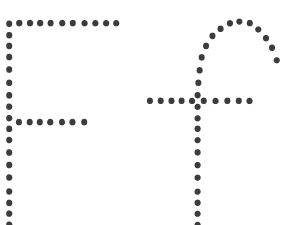
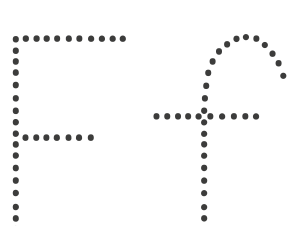
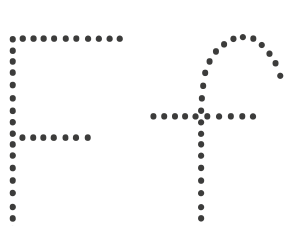
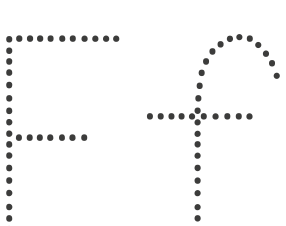
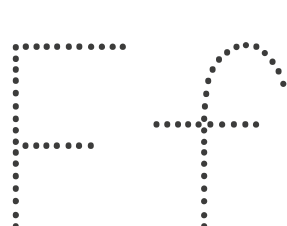
Letter F Tracing Guide

Ff Tracing Page

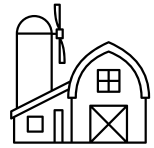
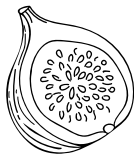

Ff Ff Ff Ff Ff Ff Ff Ff

Ff Ff Ff Ff Ff Ff Ff Ff

Ff Ff Ff Ff Ff Ff Ff Ff

Ff Ff Ff Ff Ff Ff Ff Ff

Ff Ff Ff Ff Ff Ff Ff Ff

Ff Ff Ff Ff Ff Ff Ff Ff

Ff Ff Ff Ff Ff Ff Ff Ff

Ff Ff Ff Ff Ff Ff Ff Ff

Ff Ff Ff Ff Ff Ff Ff Ff

Ff Ff Ff Ff Ff Ff Ff Ff

Flower

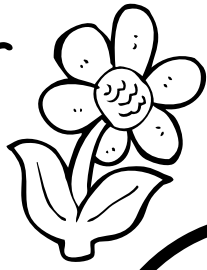

Fork

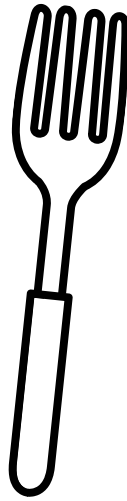

Frog

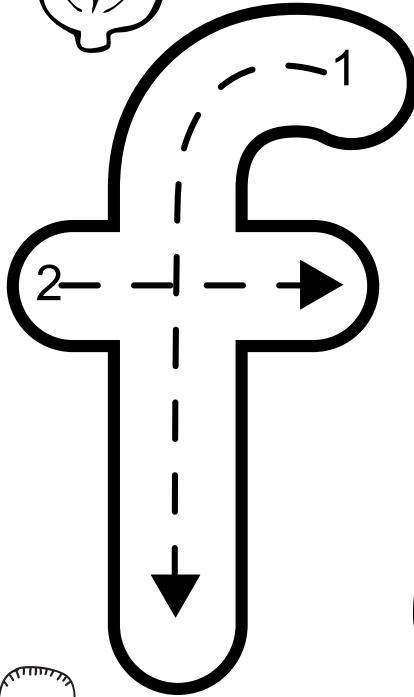
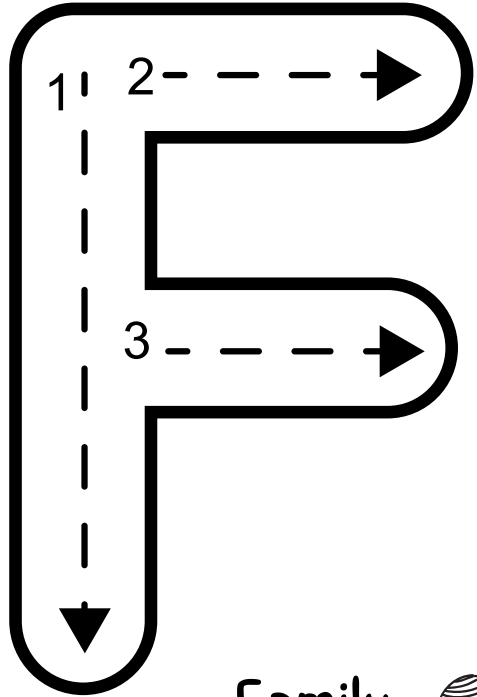
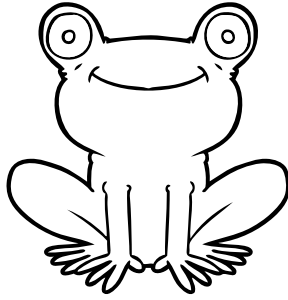

Fin

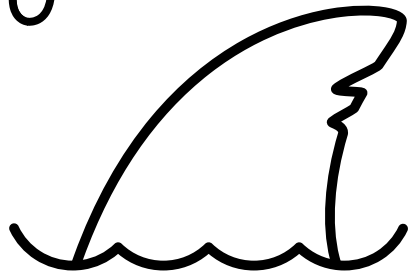

Family

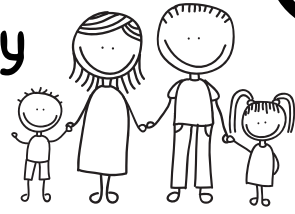

Four

Fan

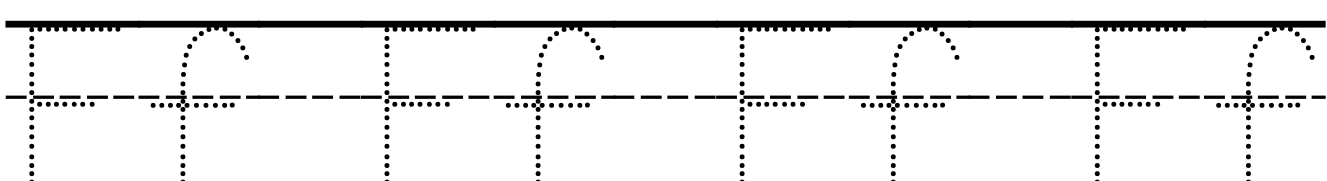
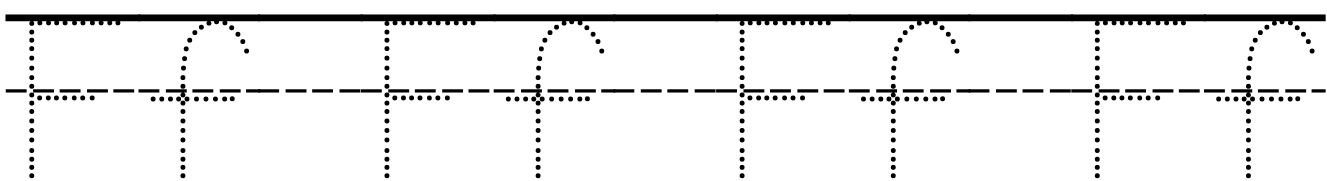
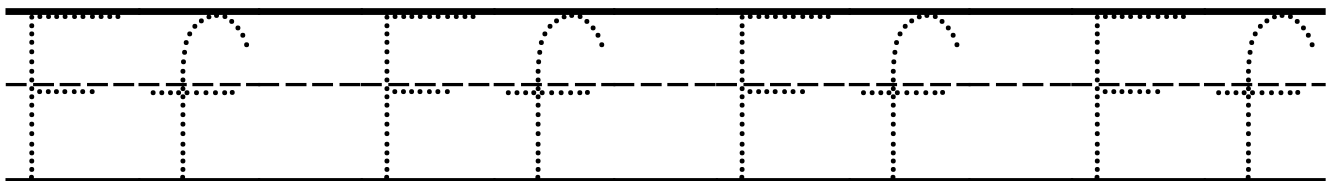
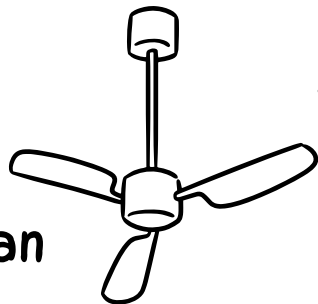

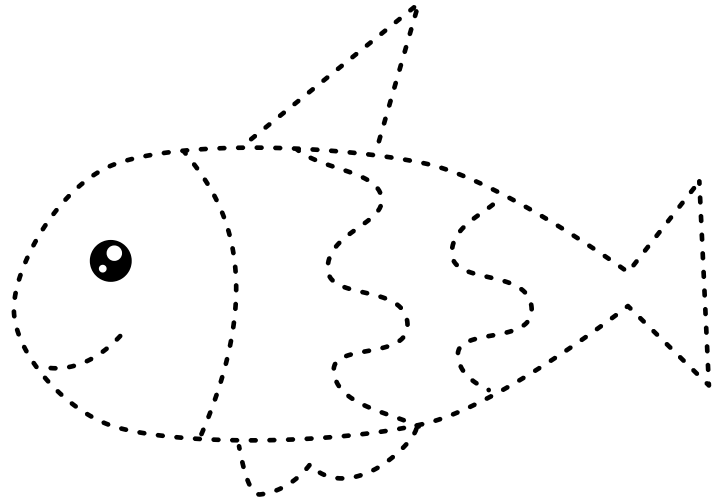
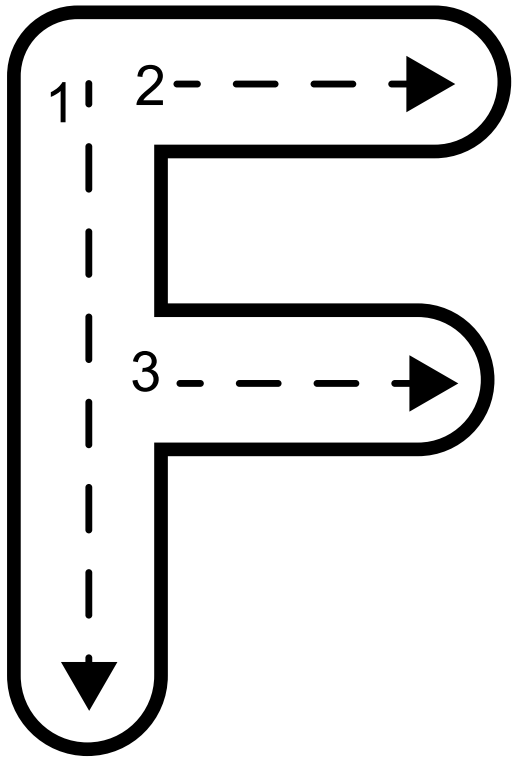

F is for Fish.

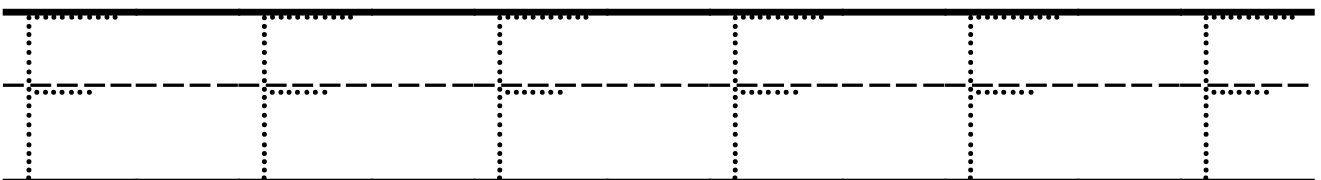
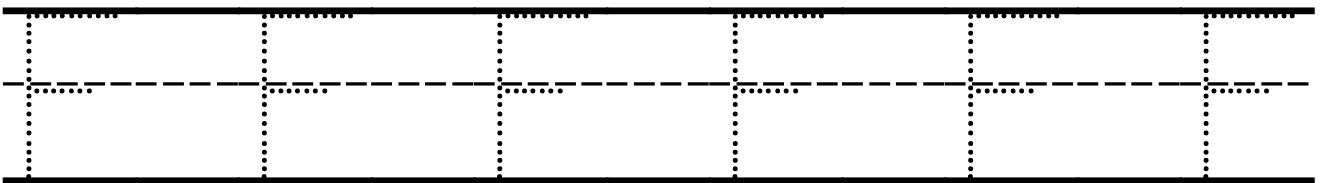
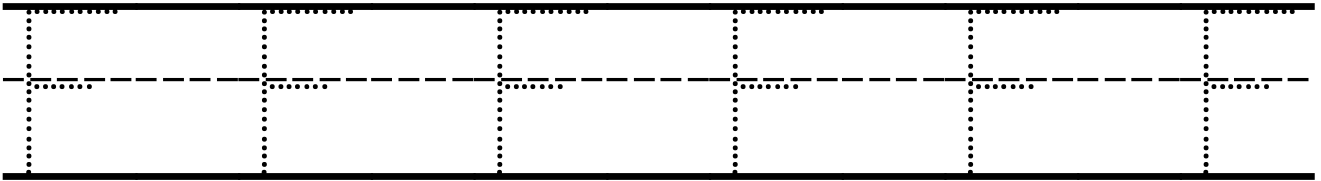

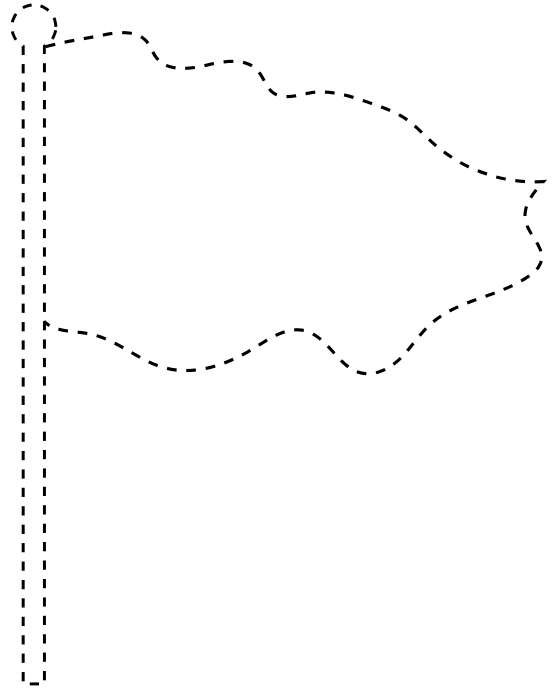
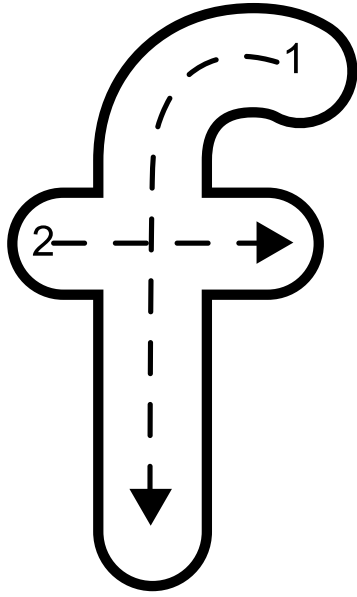

f is for flag.

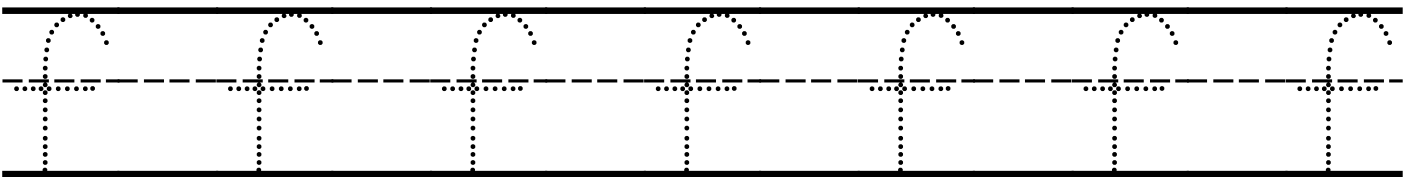
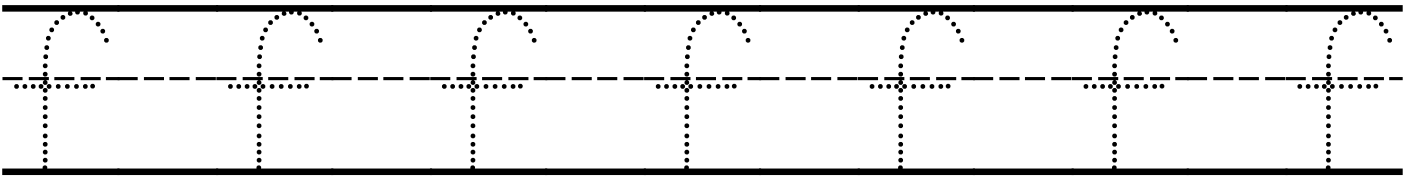
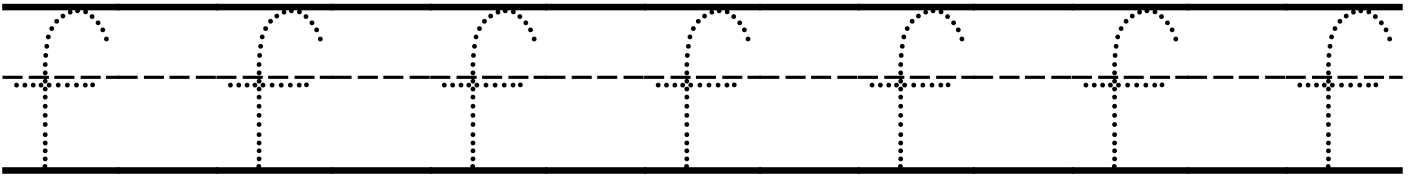

F

f

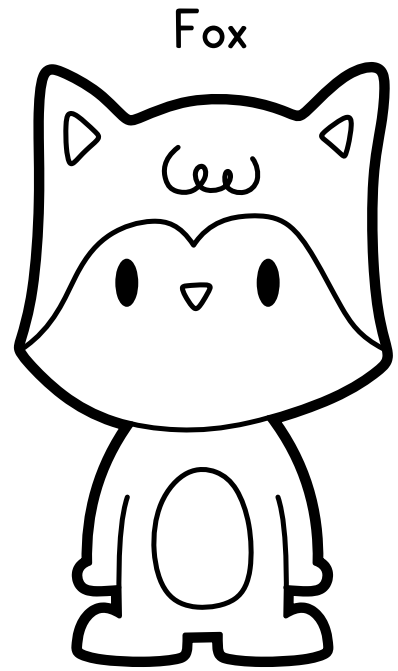

Write the letters.

F f				

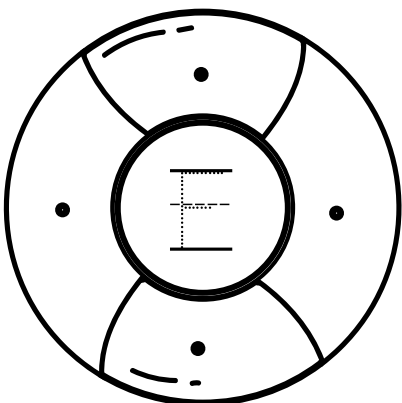
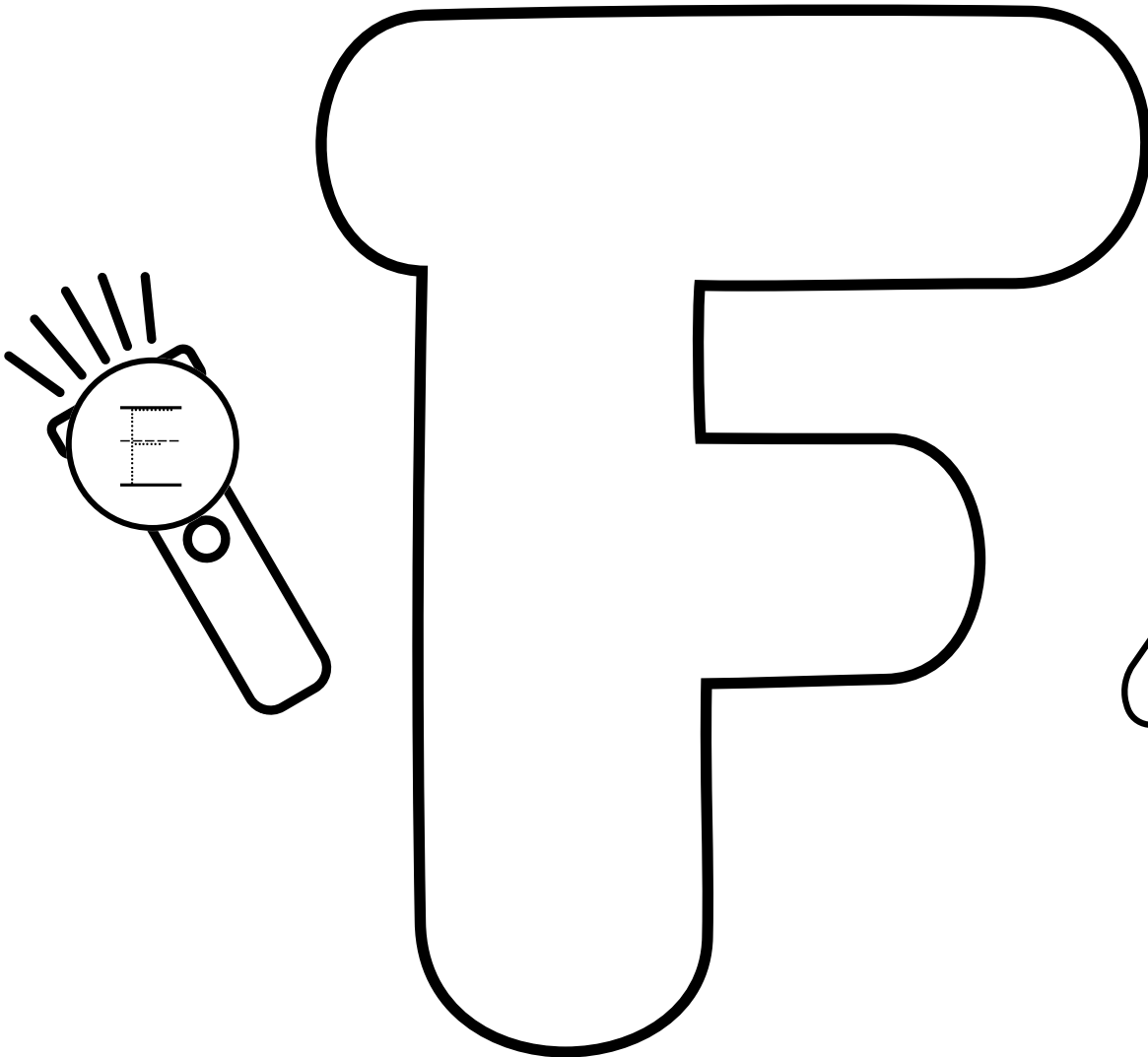
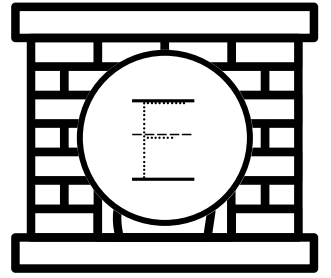
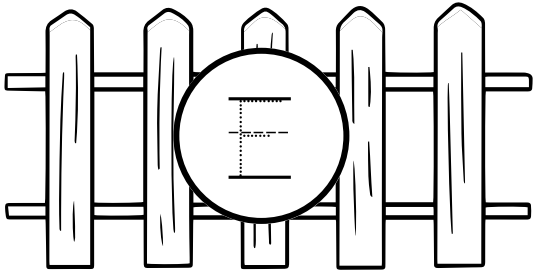

Trace and Color

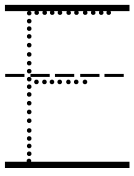

Purple

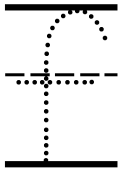

Green

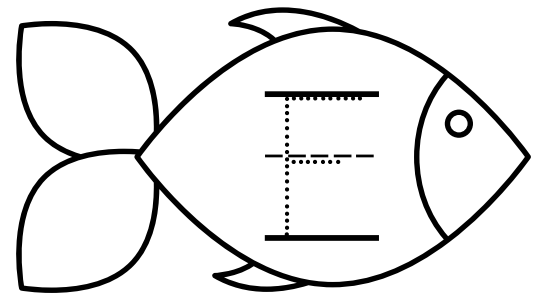
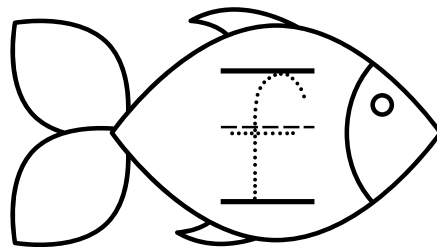
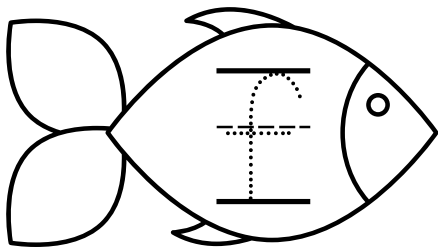
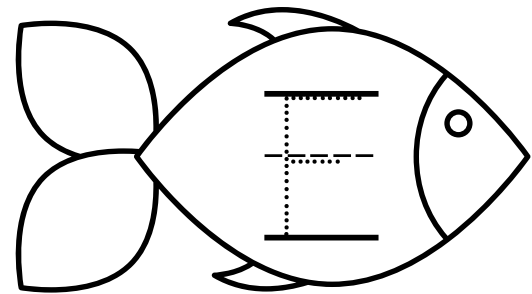
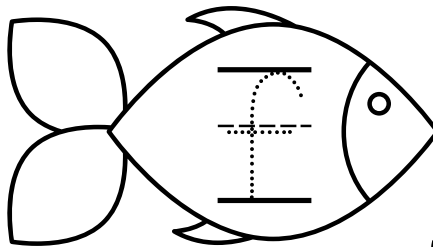
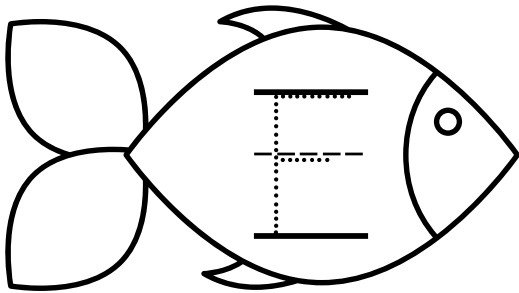
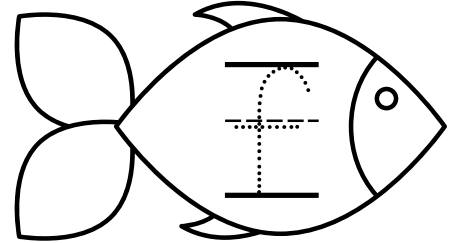
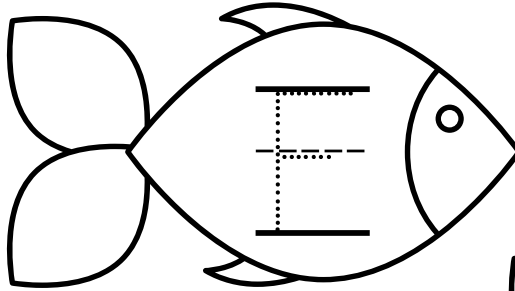
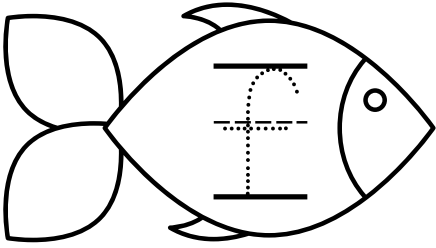
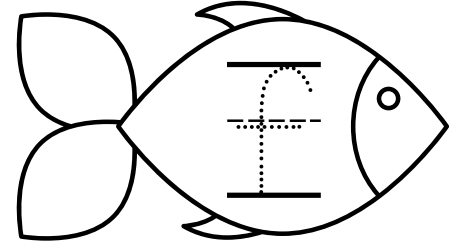
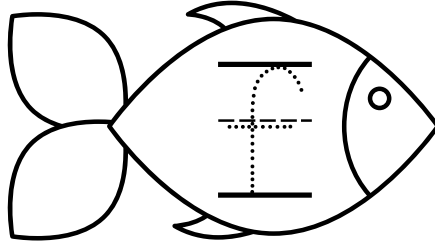
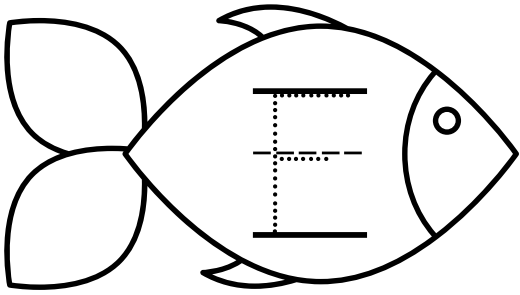
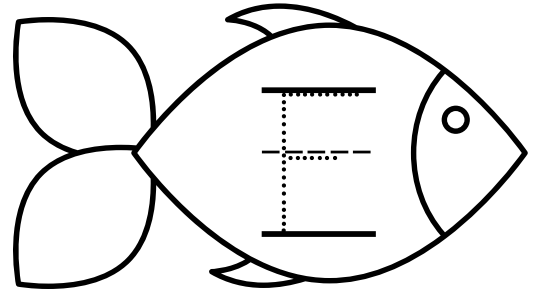
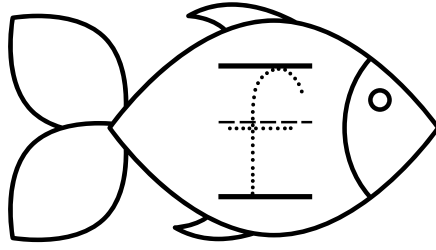

Letter F Tracing Templates

Tracing guide for uppercase F and lowercase f. The uppercase F shows three strokes: 1. a vertical line down, 2. a horizontal line across the top, and 3. a horizontal line across the middle. The lowercase f shows two strokes: 1. a curved line starting from the top right, going down and then curving to the left, and 2. a horizontal line across the middle. Illustrations of a fennel bulb and a slice of citrus are included.

Ff Ff Ff
Ff Ff Ff

Tracing guide for uppercase F and lowercase f. A solid uppercase F and a solid lowercase f are shown at the top. Below them is a large, dotted path for tracing, starting with a solid uppercase F and ending with a solid lowercase f.

A large dotted uppercase letter F for tracing.

A large dotted lowercase letter f for tracing.

Ff Tracing Page with Pictures

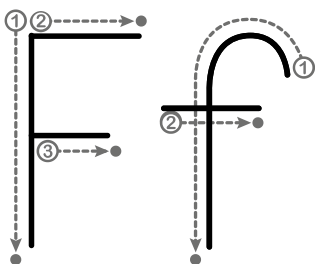
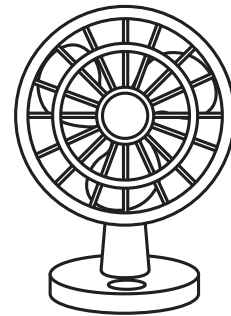
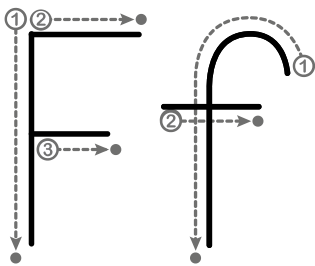
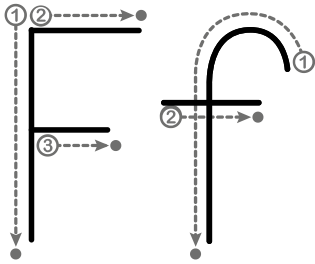
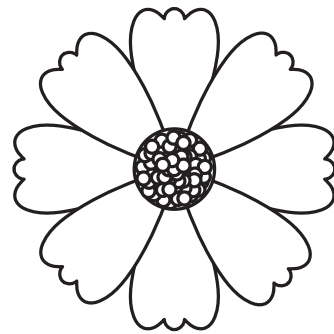
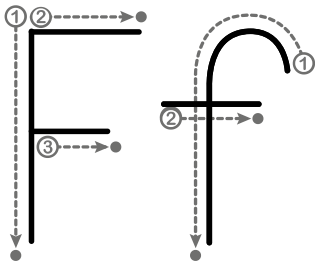
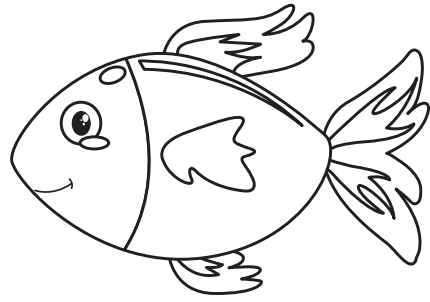
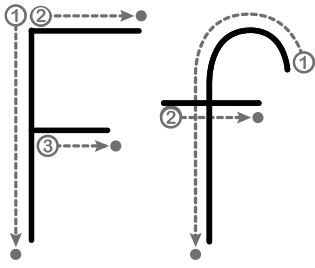

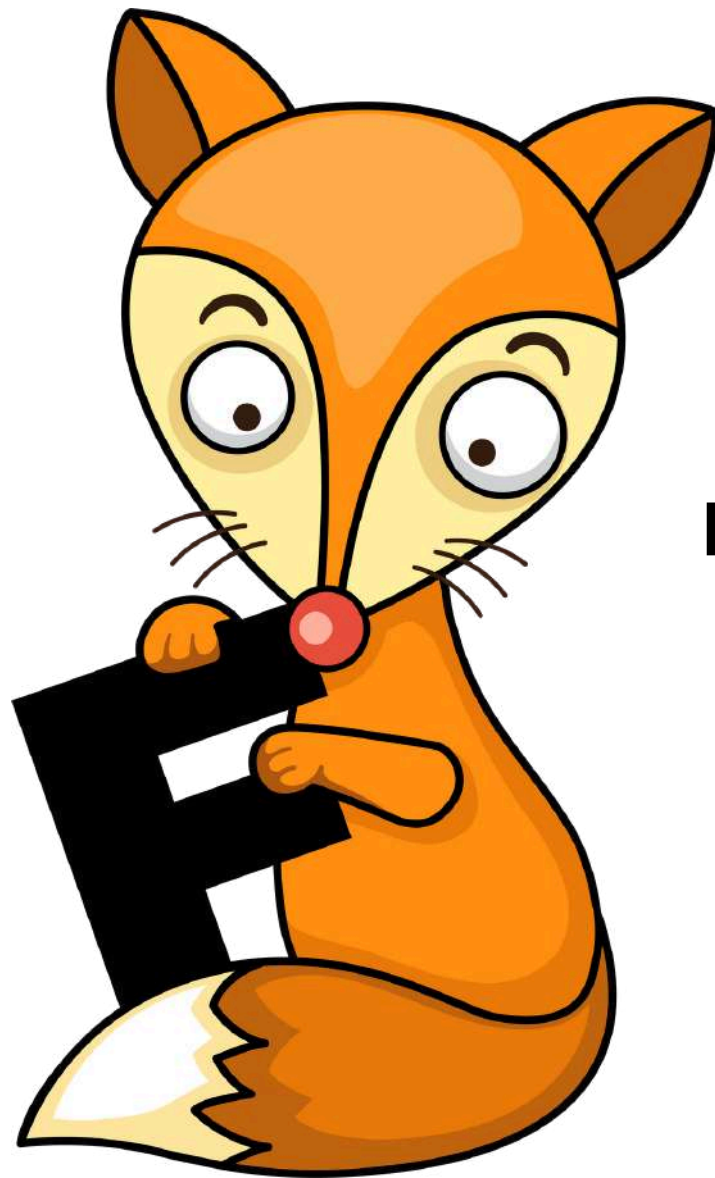

Fox

