

WRITING LETTERS

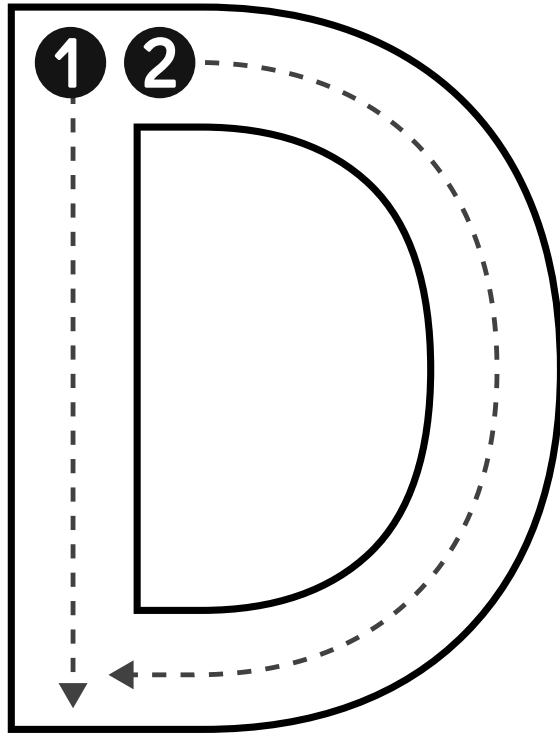

D D D D D

Handwriting practice lines consisting of two sets of three horizontal lines each. Each set includes a solid top line, a dashed middle line, and a solid bottom line.

WRITING LETTERS

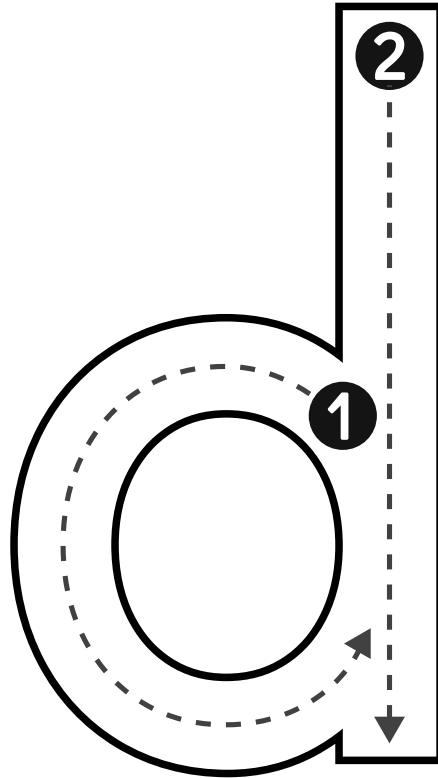

d d d d d

Handwriting practice lines consisting of two sets of four horizontal lines each. Each set includes a solid top line, a dashed middle line, and a solid bottom line.

Uppercase D Tracing Practice

D D D D D D D D D D D D D D D D

D D D D D D D D D D D D D D D D

D D D D D D D D D D D D D D D D

D D D D D D D D D D D D D D D D

D D D D D D D D D D D D D D D D

D D D D D D D D D D D D D D D D

D D D D D D D D D D D D D D D D

D D D D D D D D D D D D D D D D

D D D D D D D D D D D D D D D D

D D D D D D D D D D D D D D D D

D D D D D D D D D D D D D D D D

D D D D D D D D D D D D D D D D

D D D D D D D D D D D D D D D D

D D D D D D D D D D D D D D D D

D D D D D D D D D D D D D D D D

Lowercase d Tracing Practice

d

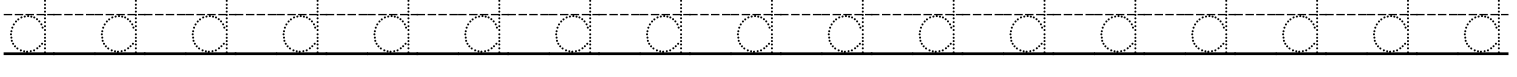
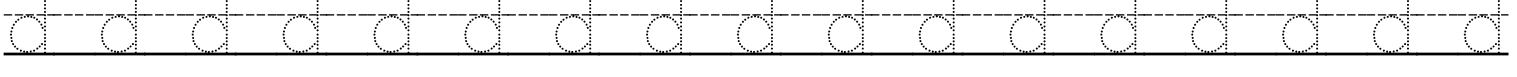
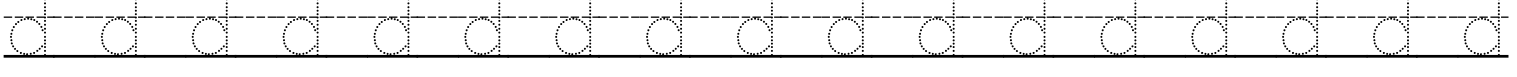
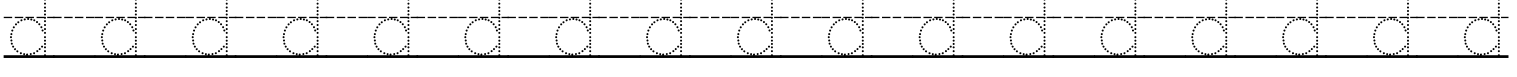
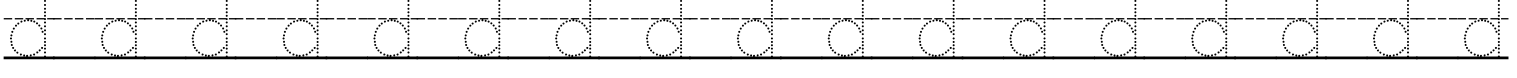
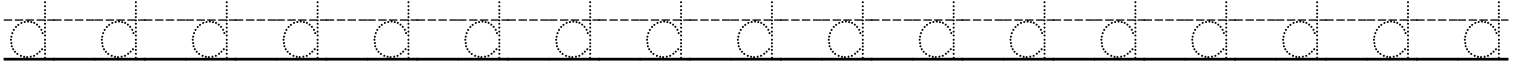
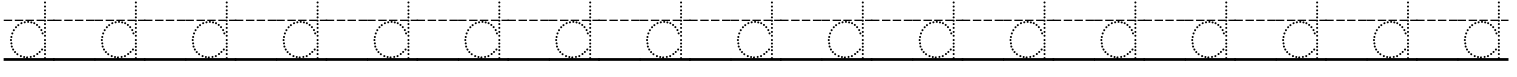
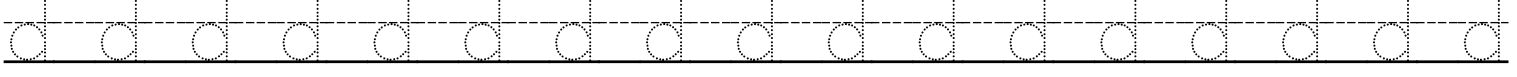
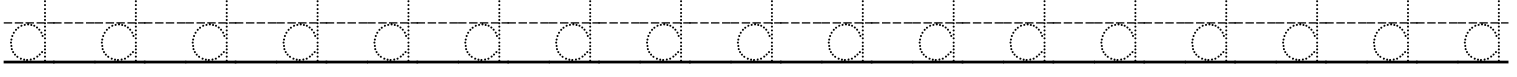
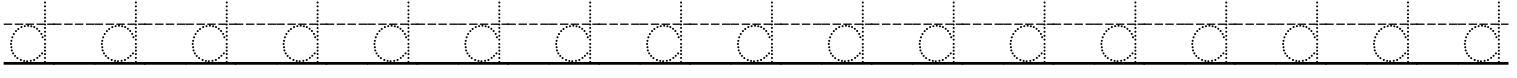
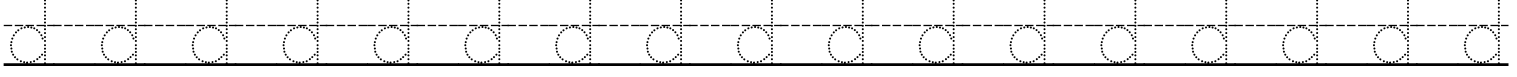
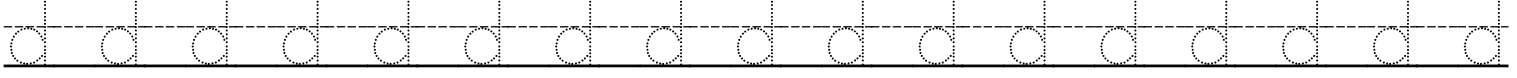
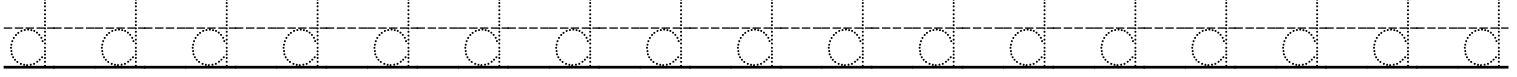
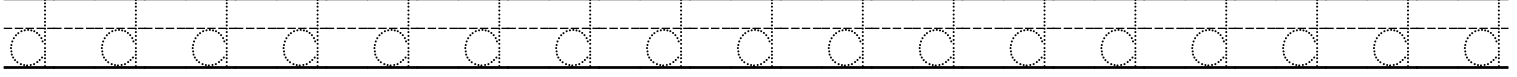
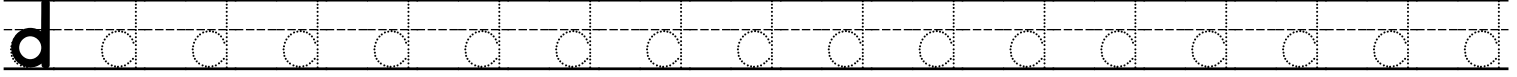

Dd

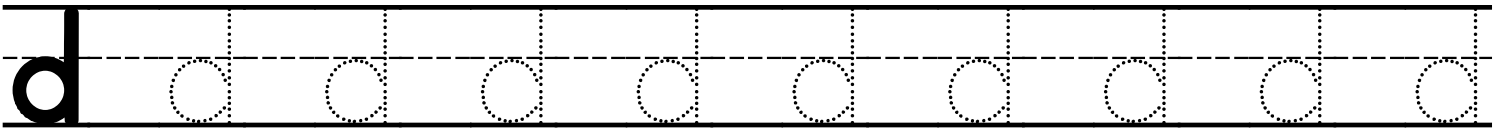
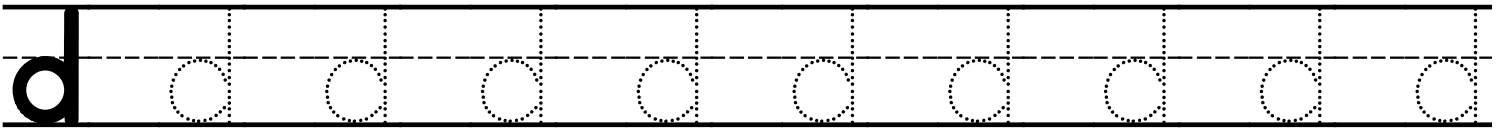
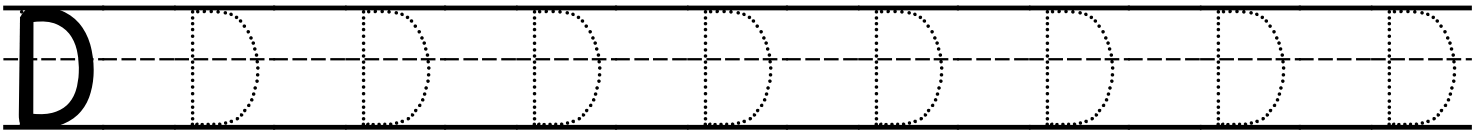
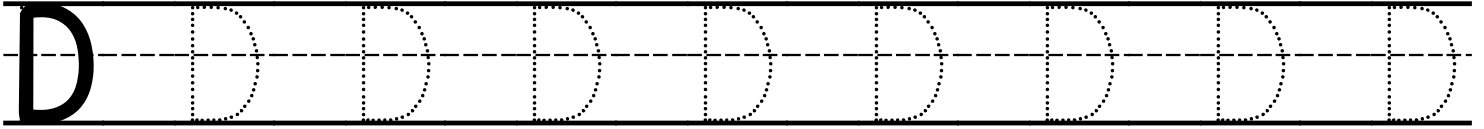
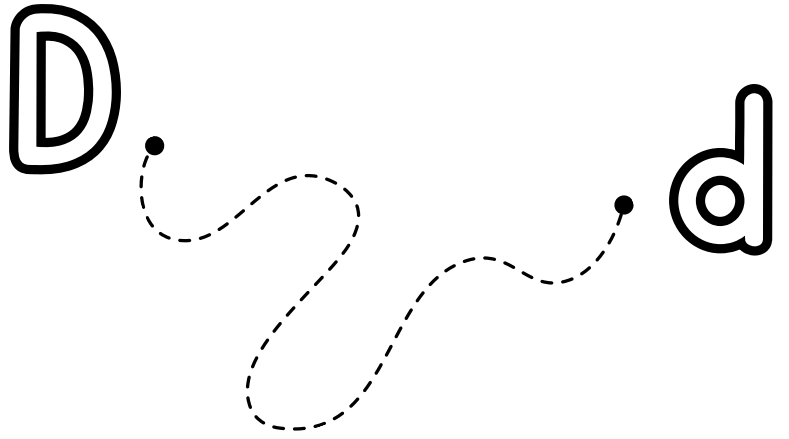

Find the letter Dd.

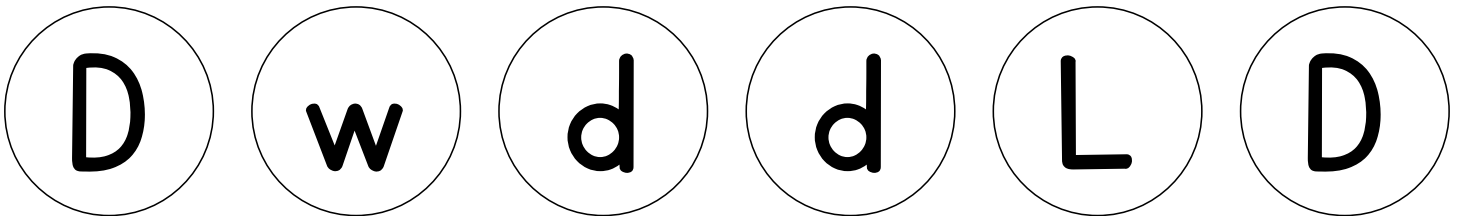
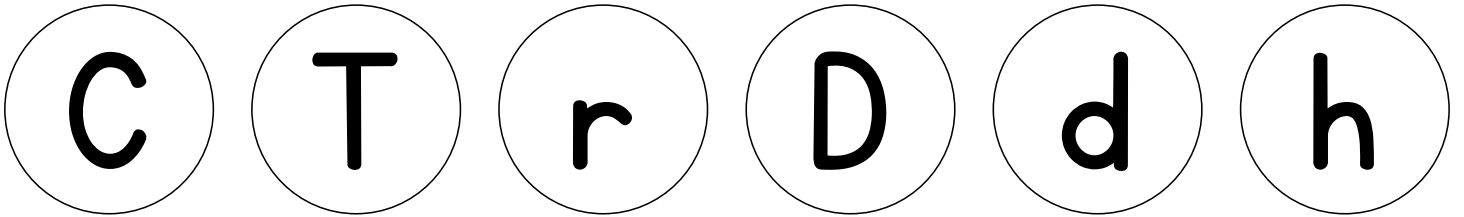
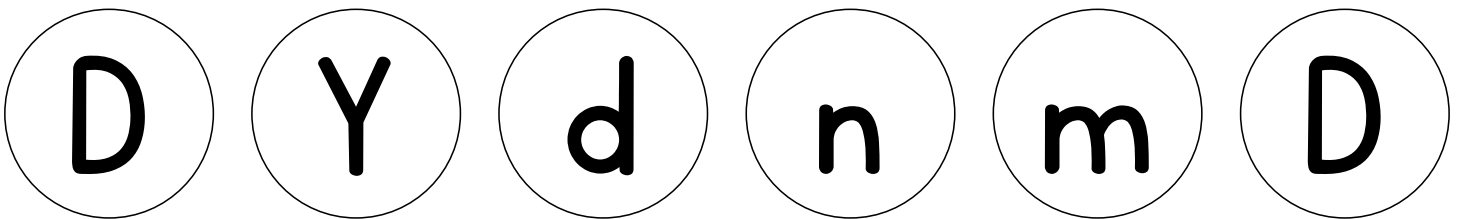

Trace the route from letter to letter.

D

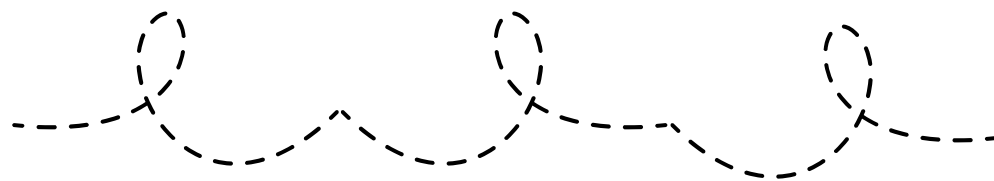

d

d

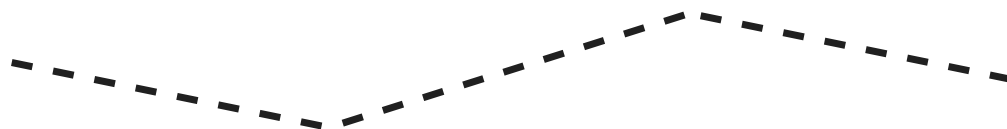

D

D

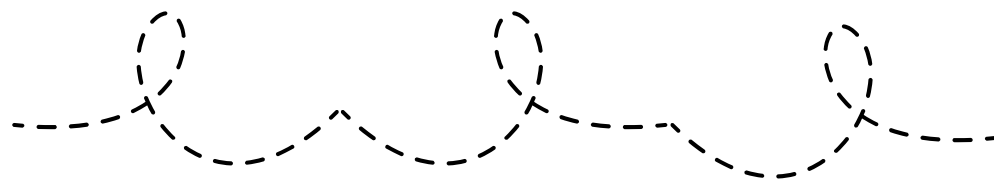

d

d

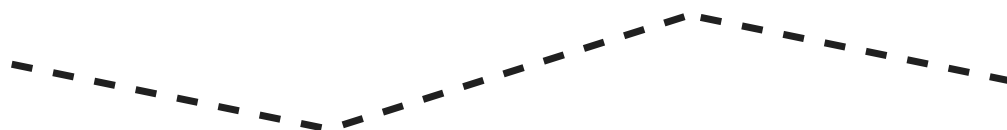

D

D

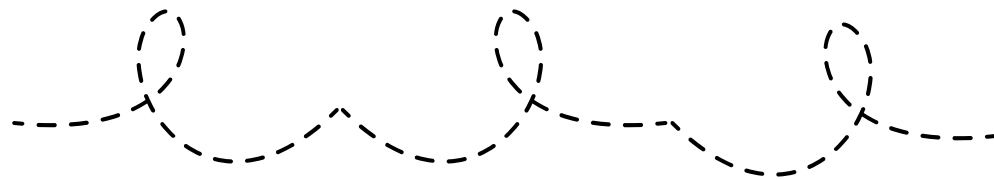

d

d

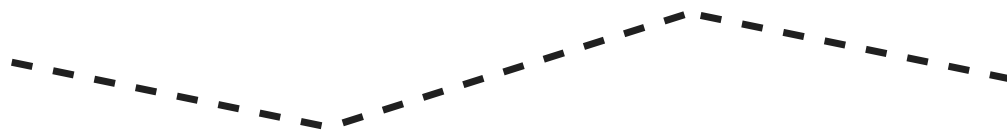

D

D

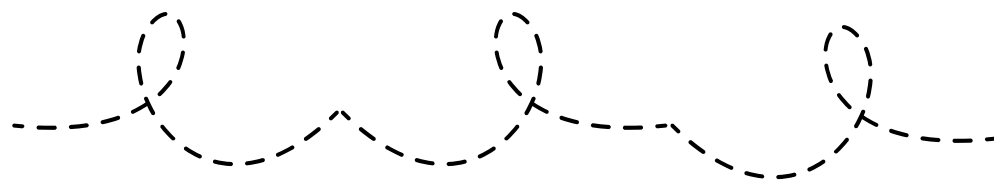

d

d

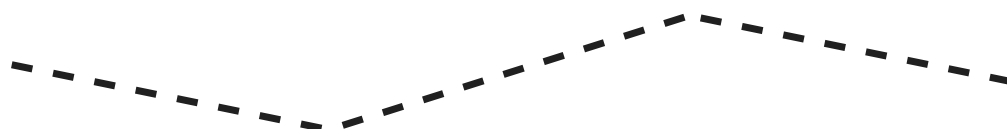

D

Letter D Uppercase Maze

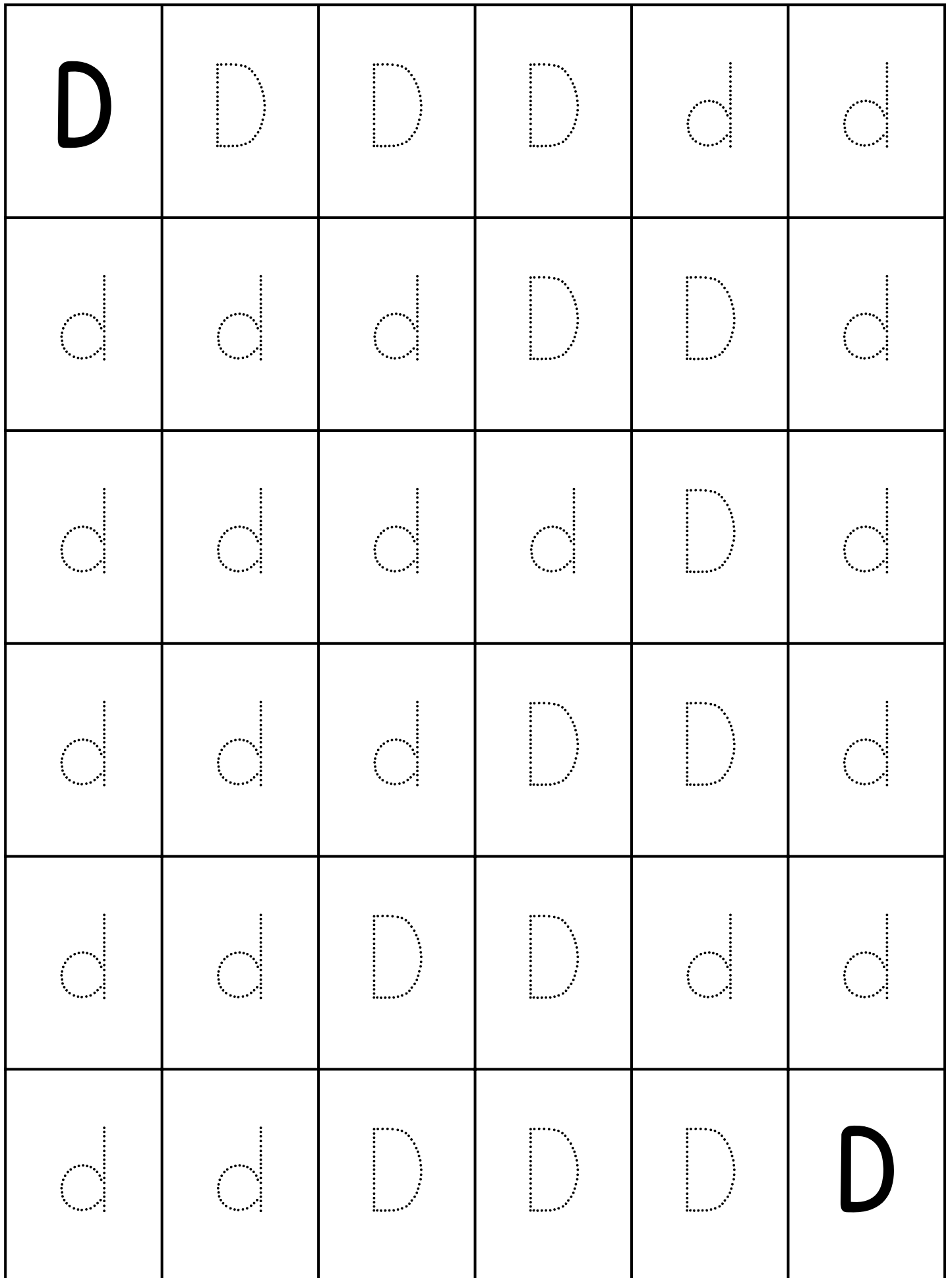

Letter d Lowercase Maze

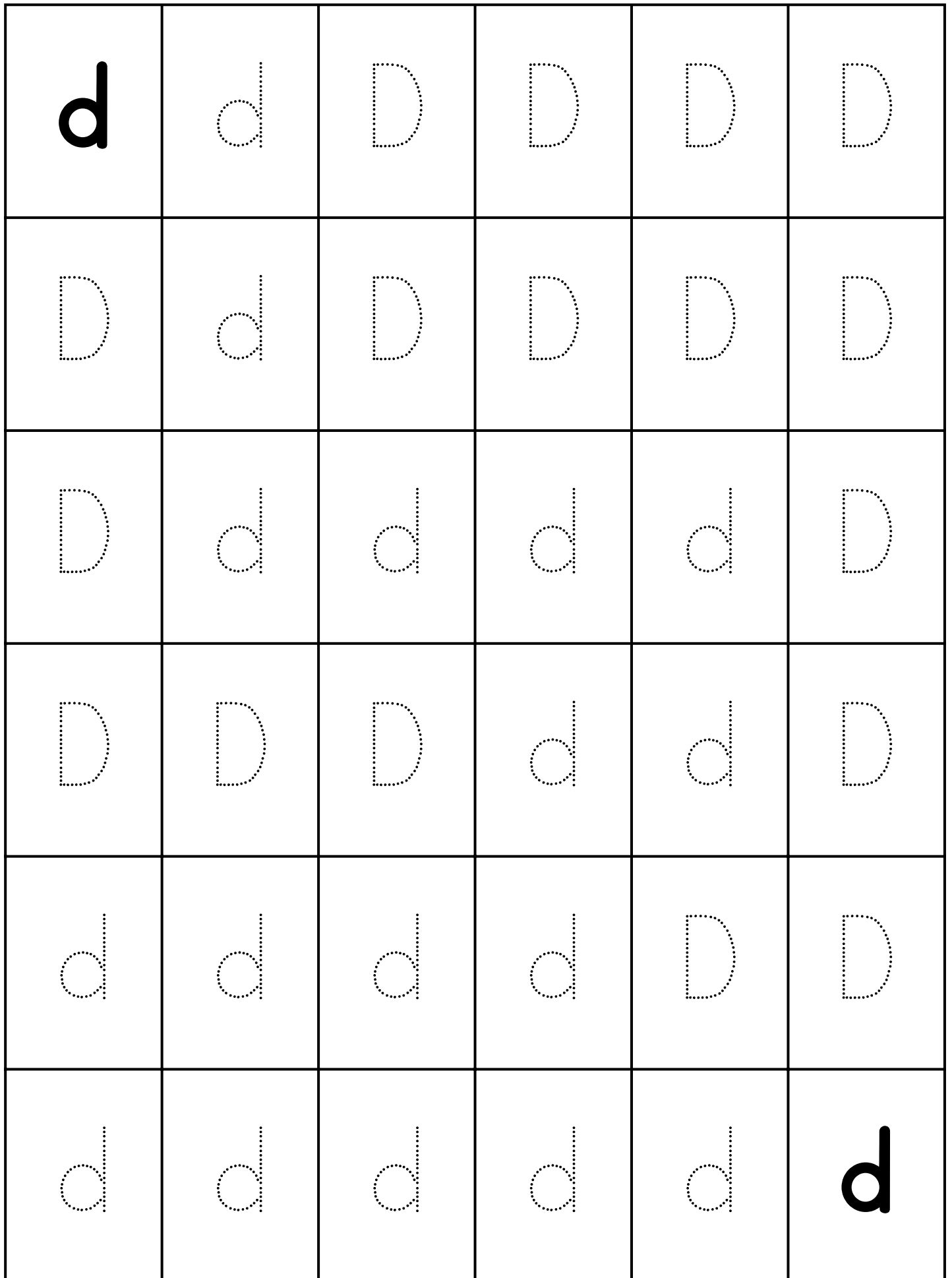

Letters Tracing Bundle

D

D

D

D

D

D

D

D

D

D

D

D

d

d

d

d

d

d

d

d

d

d

d

d

Letter D Tracing Guide

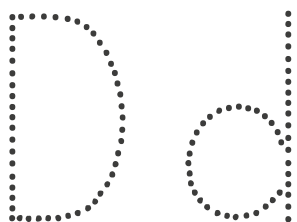
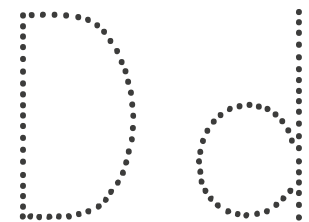
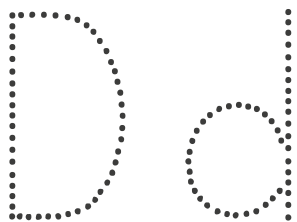
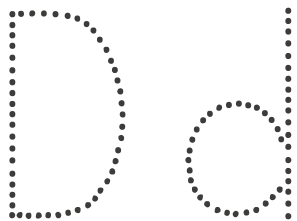
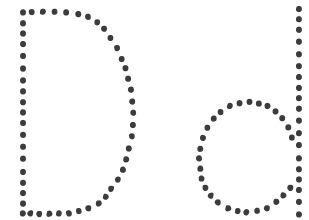
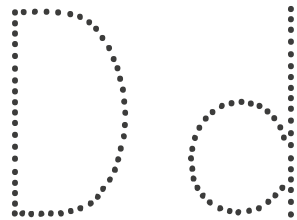
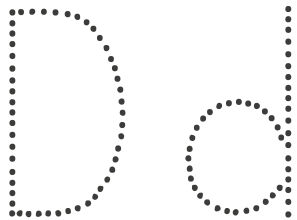
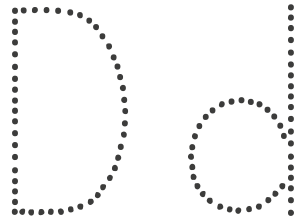
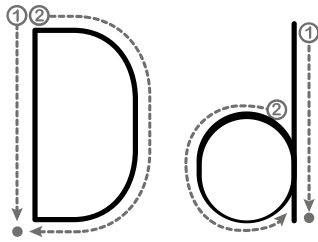

Dd Tracing Page

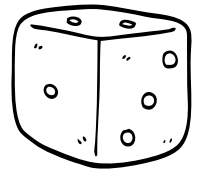
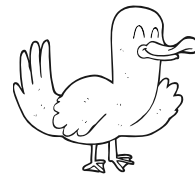

Dd Dd Dd Dd Dd Dd Dd

Dd Dd Dd Dd Dd Dd Dd

Dd Dd Dd Dd Dd Dd Dd

Dd Dd Dd Dd Dd Dd Dd

Dd Dd Dd Dd Dd Dd Dd

Dd Dd Dd Dd Dd Dd Dd

Dd Dd Dd Dd Dd Dd Dd

Dd Dd Dd Dd Dd Dd Dd

Dd Dd Dd Dd Dd Dd Dd

Dd Dd Dd Dd Dd Dd Dd

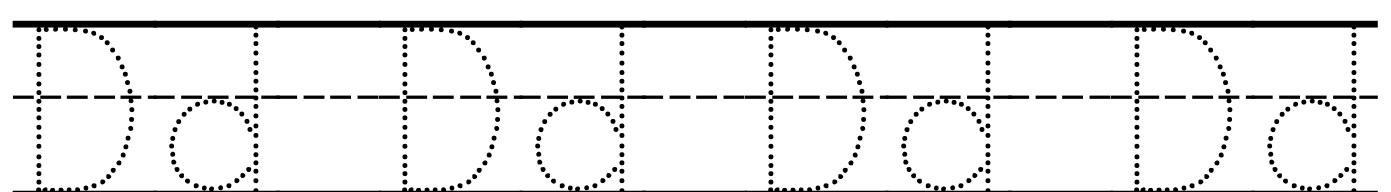
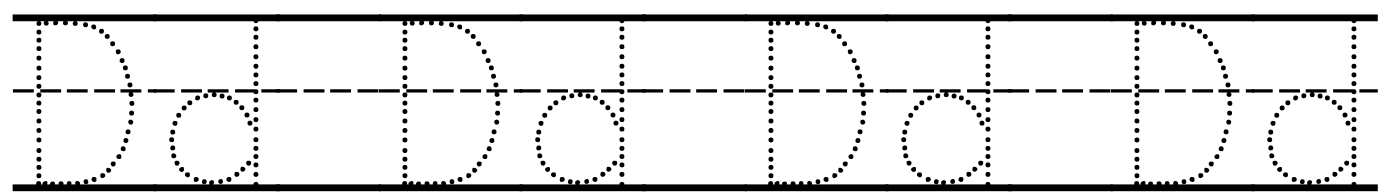
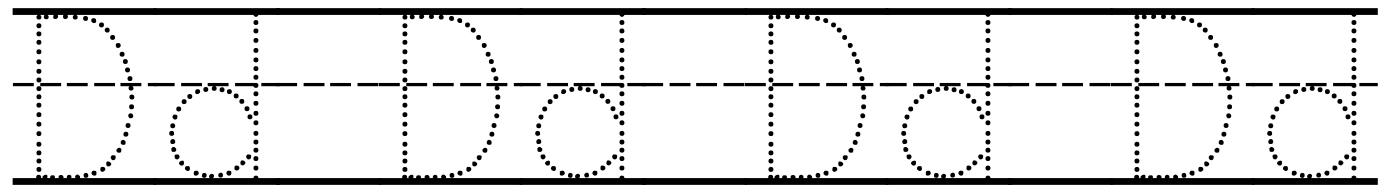
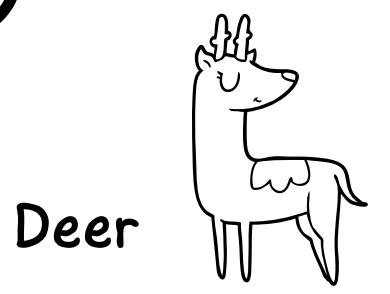
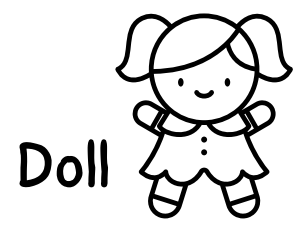
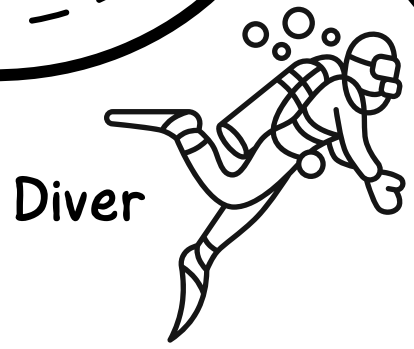
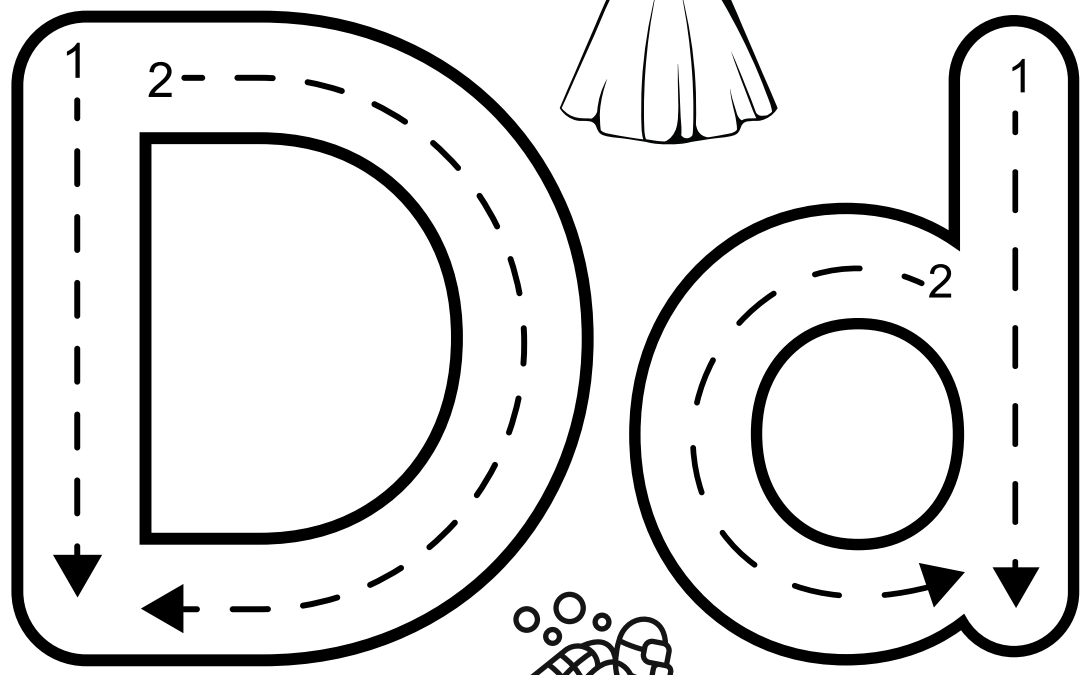

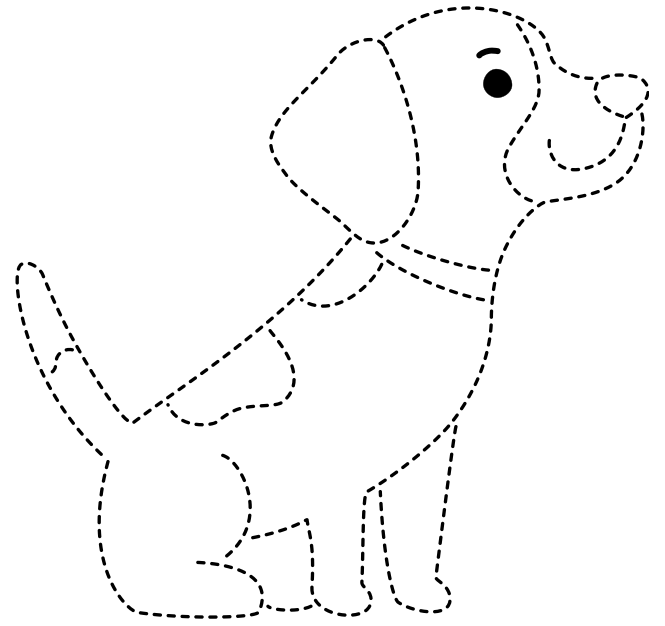
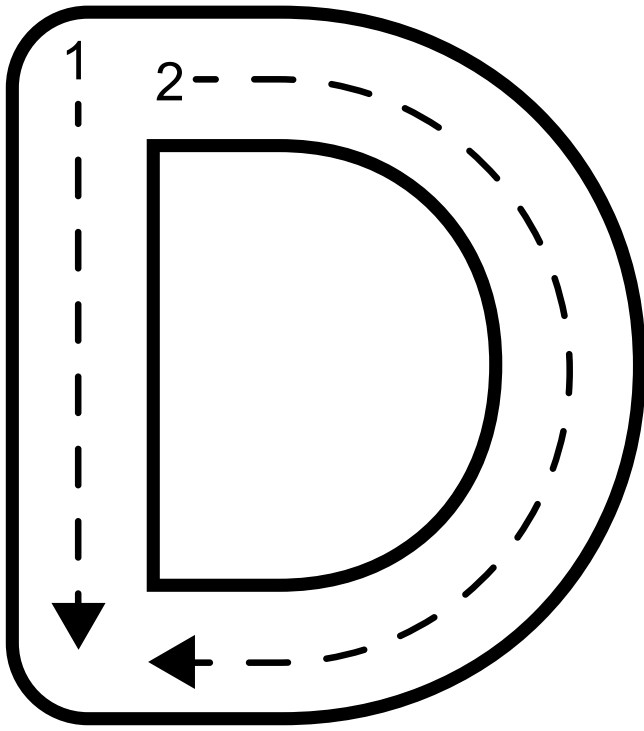

D is for Dog.

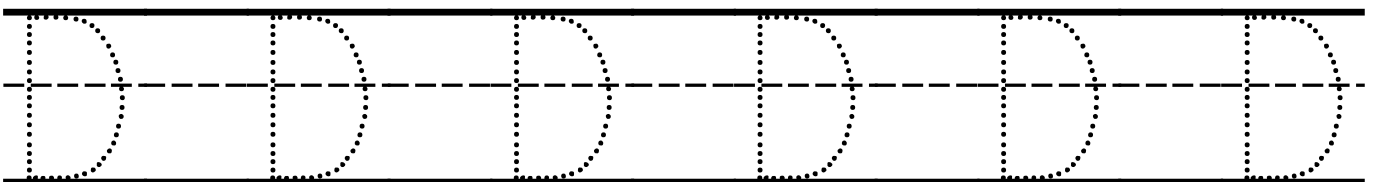
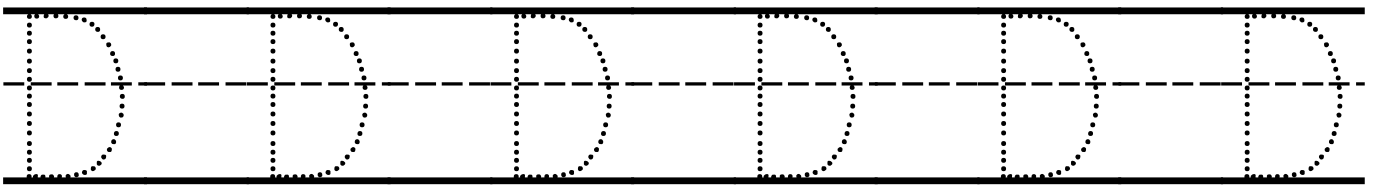
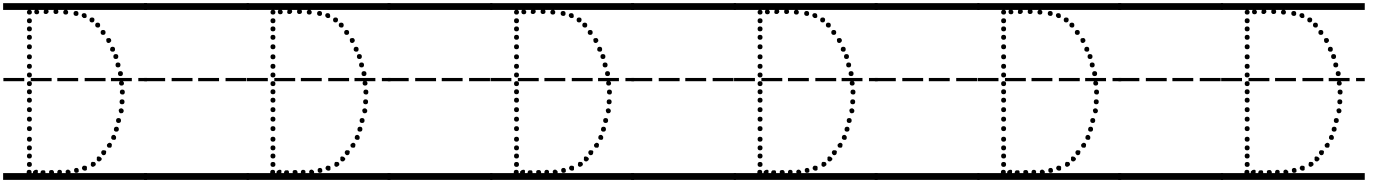

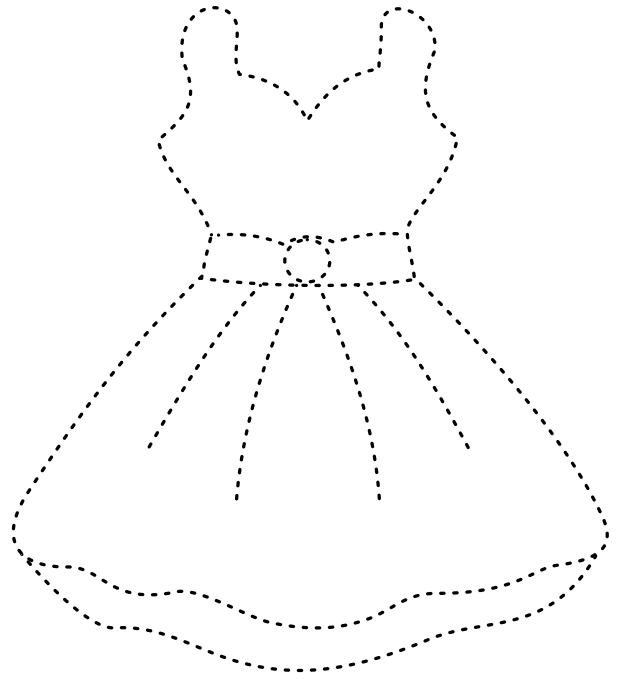
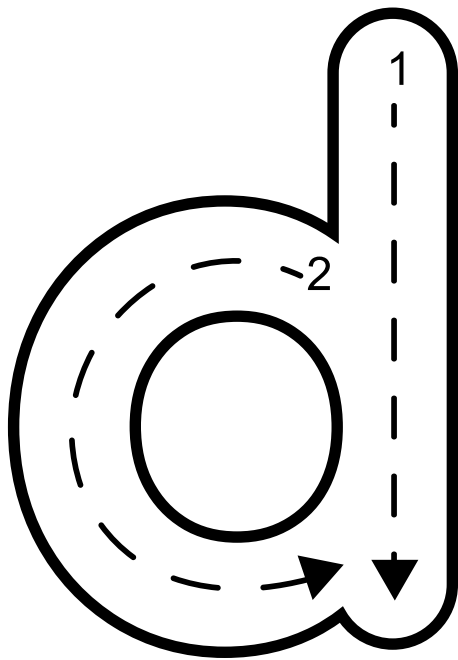

d is for dress.

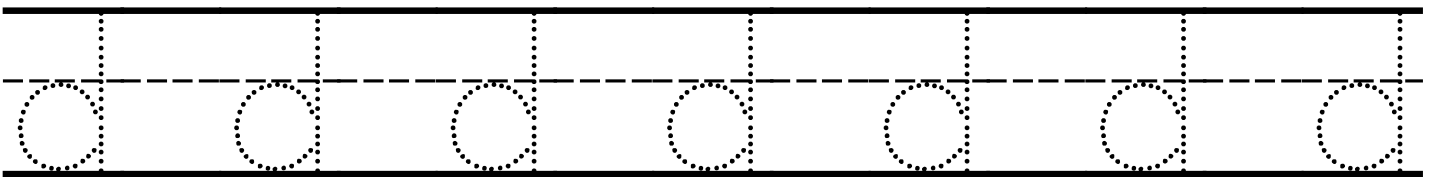
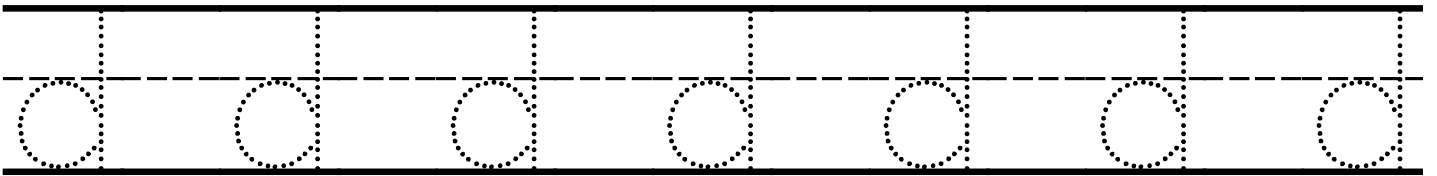
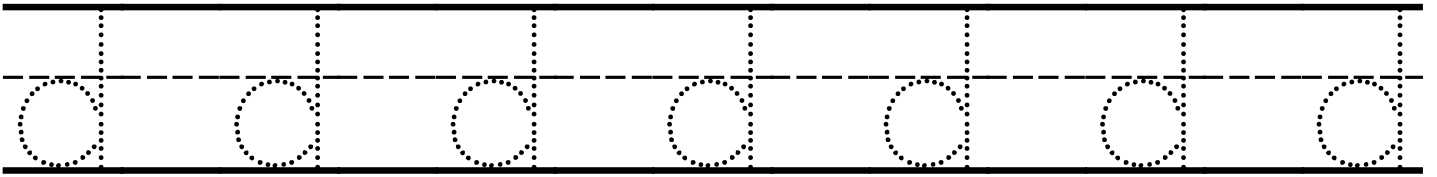

D d

Dog

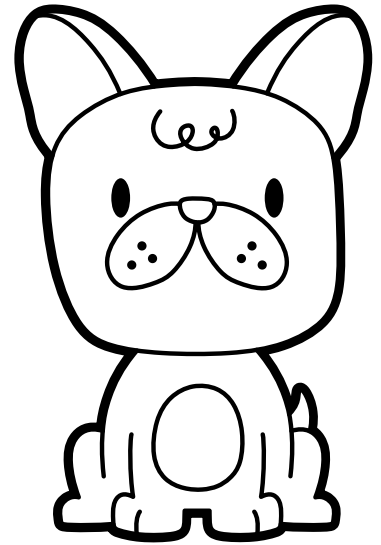

Write the letters.

D d				

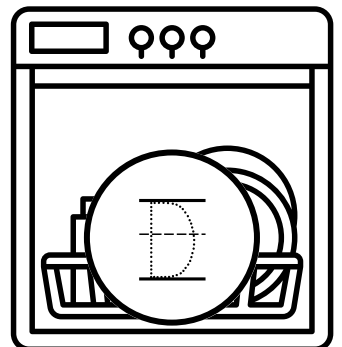
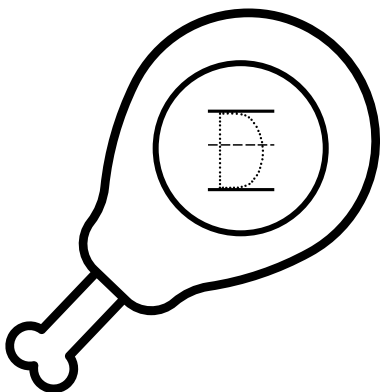
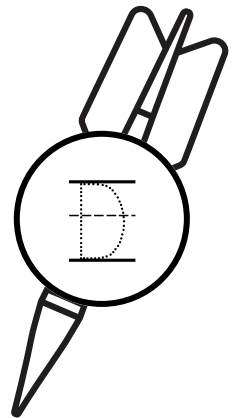
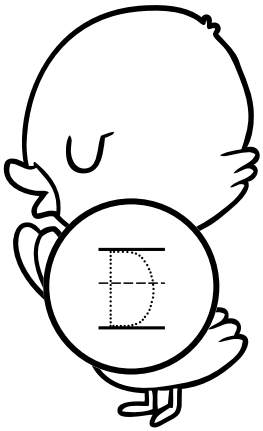
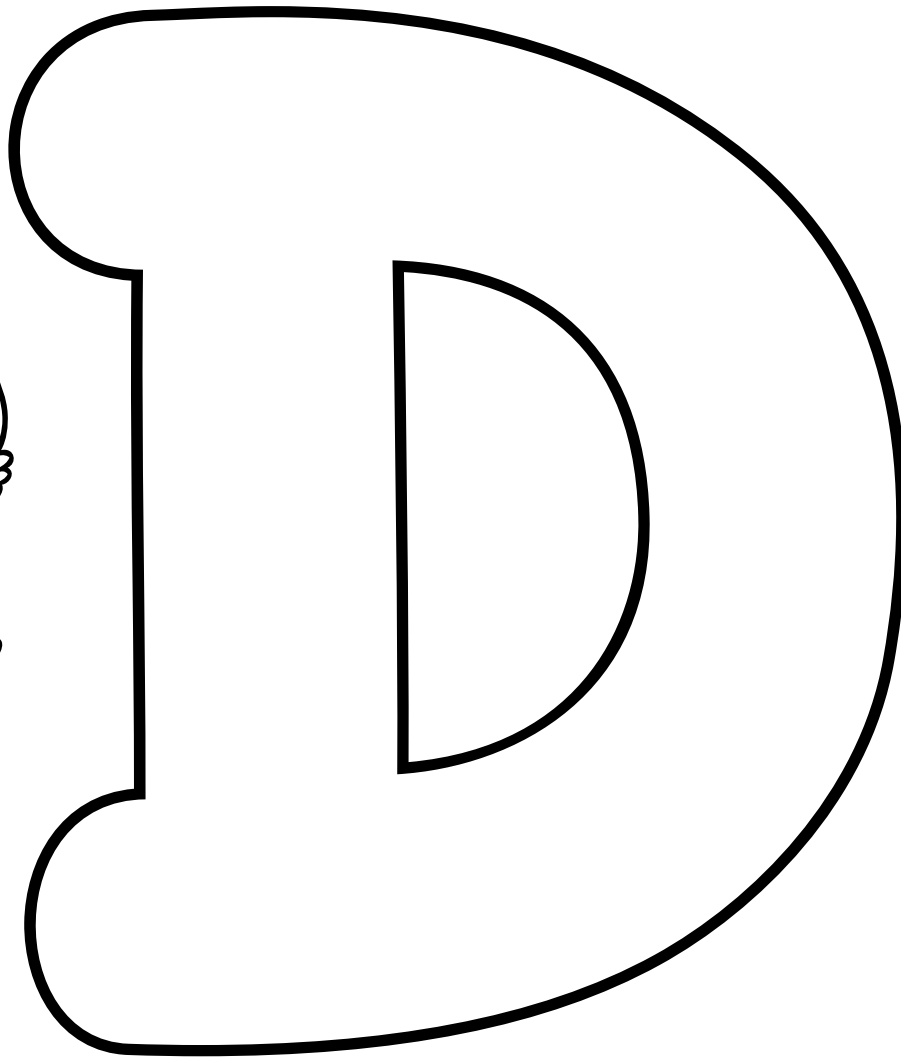
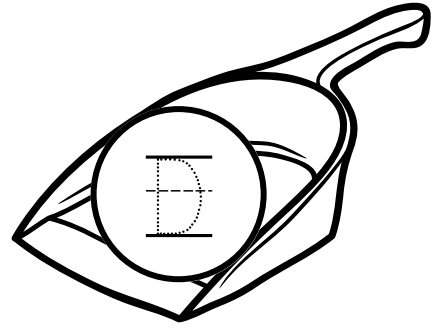
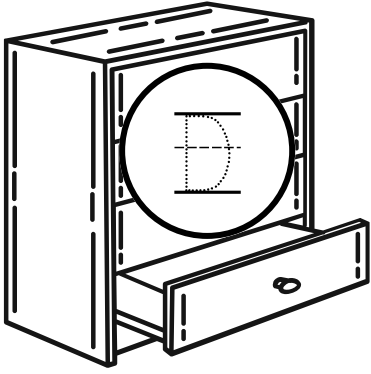

Trace and Color

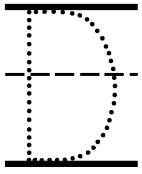

Green

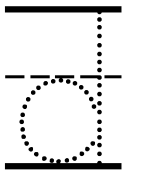

Red

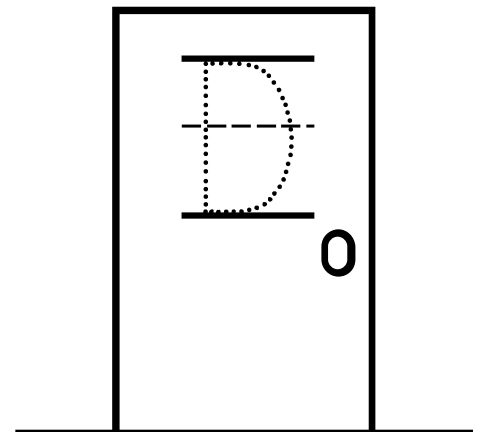
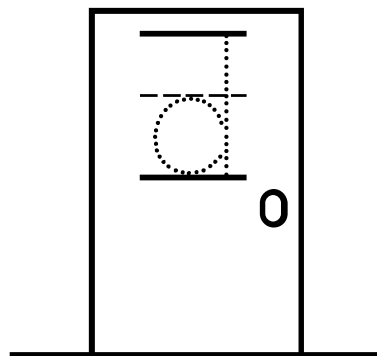
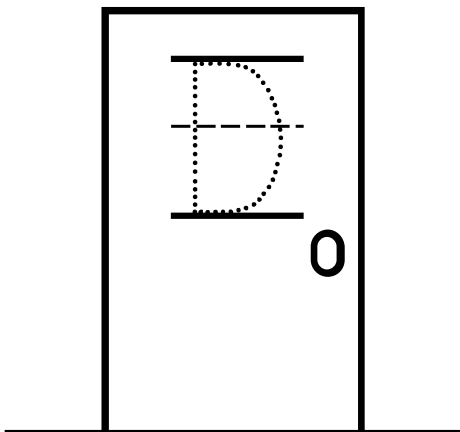
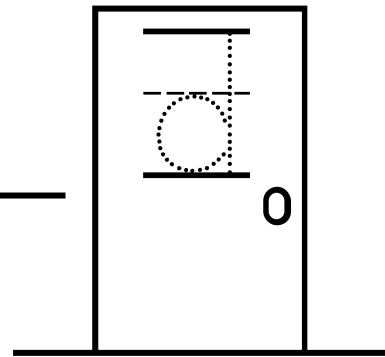
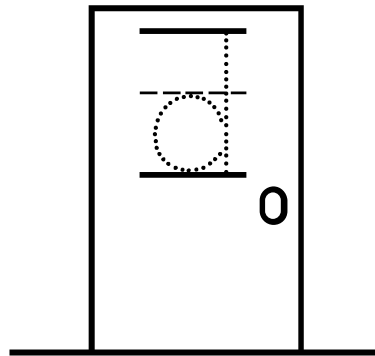
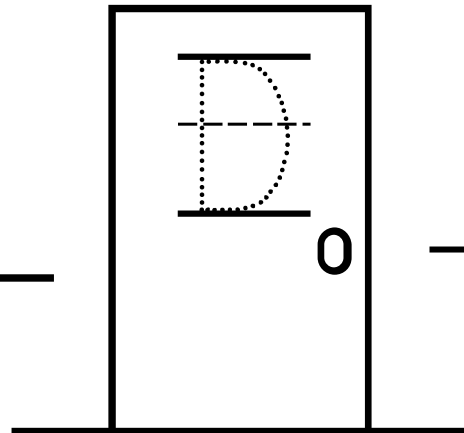
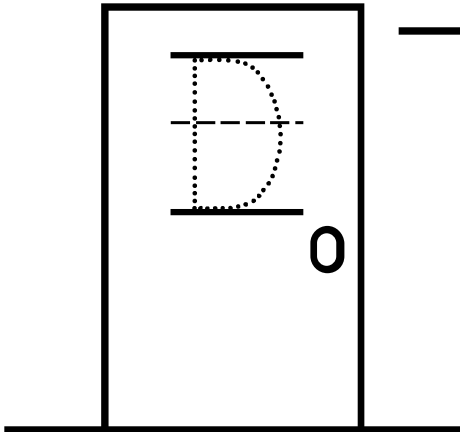
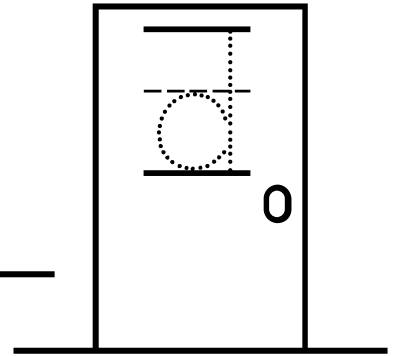
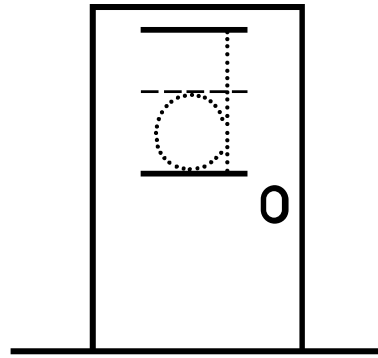
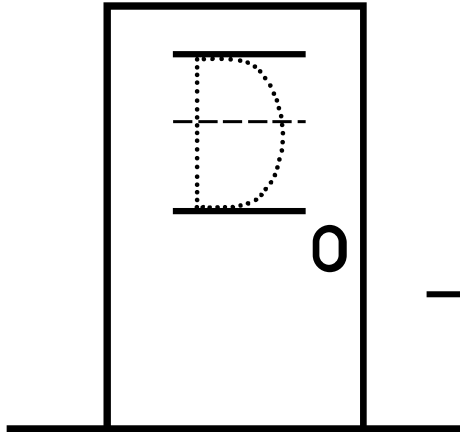
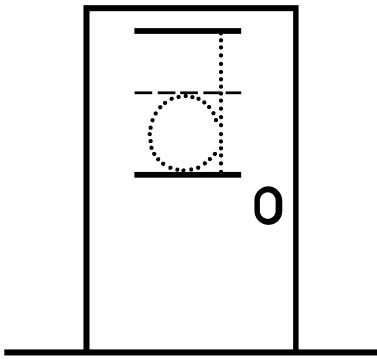
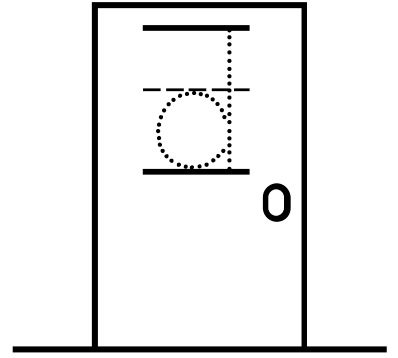
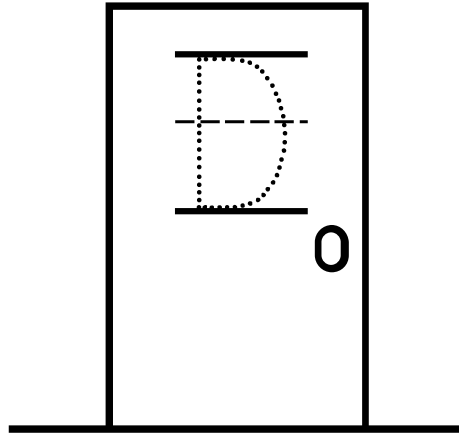

Letter D Tracing Templates

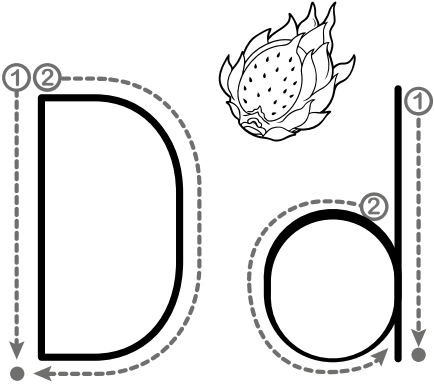

Tracing guide for uppercase D and lowercase d. The uppercase D shows stroke 1 as a vertical line down and stroke 2 as a curved line from top to bottom. The lowercase d shows stroke 1 as a vertical line down and stroke 2 as a counter-clockwise curve. A dragon fruit is illustrated above the lowercase d.

D d D d D d
D d D d D d

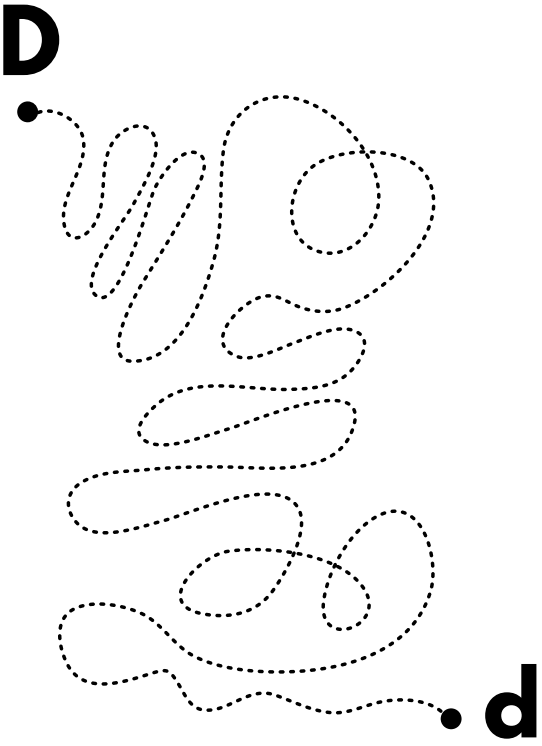

Tracing guide for uppercase D and lowercase d. The uppercase D is shown as a large dotted outline. The lowercase d is shown as a large dotted outline. A small solid lowercase d is shown at the bottom right.

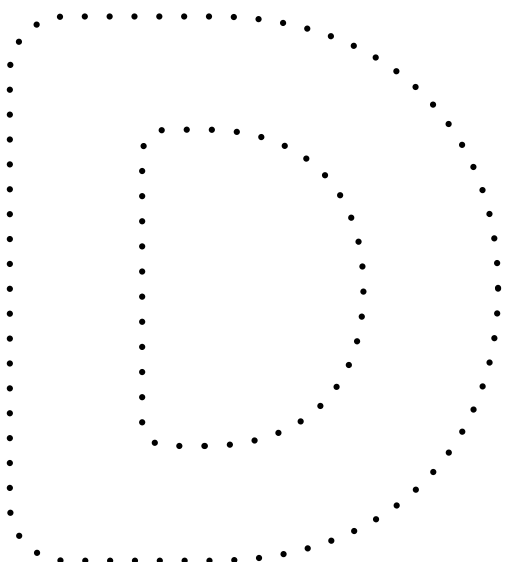

Large dotted outline of uppercase D for tracing.

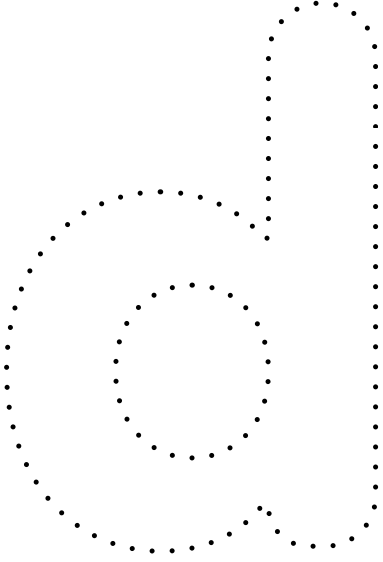

Large dotted outline of lowercase d for tracing.

Dd Tracing Page with Pictures

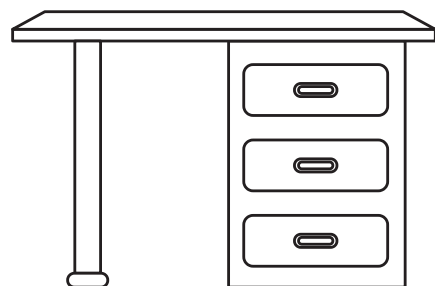
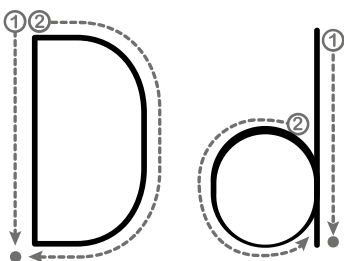
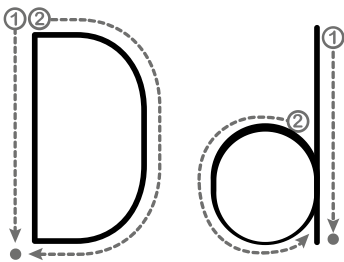
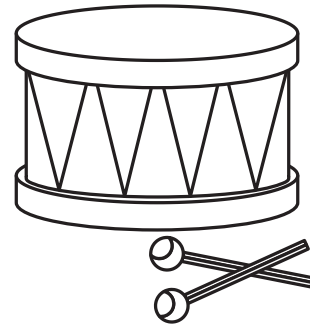
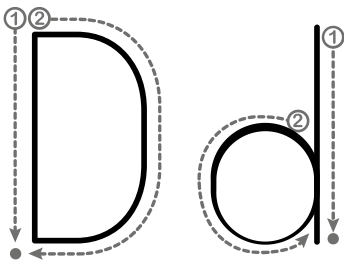
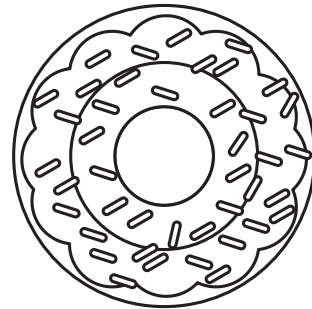
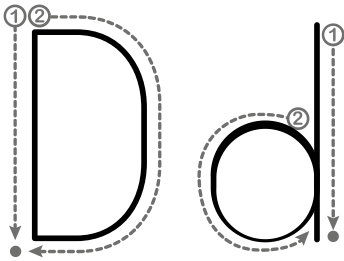
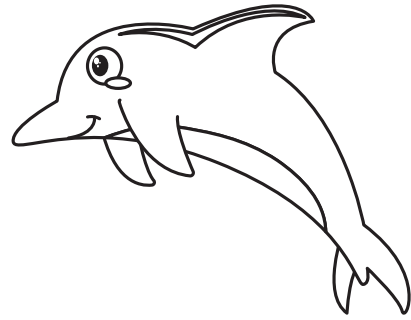
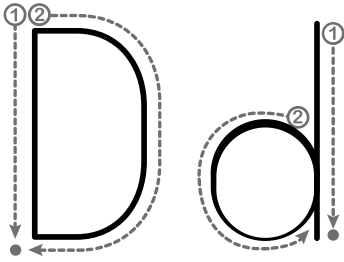

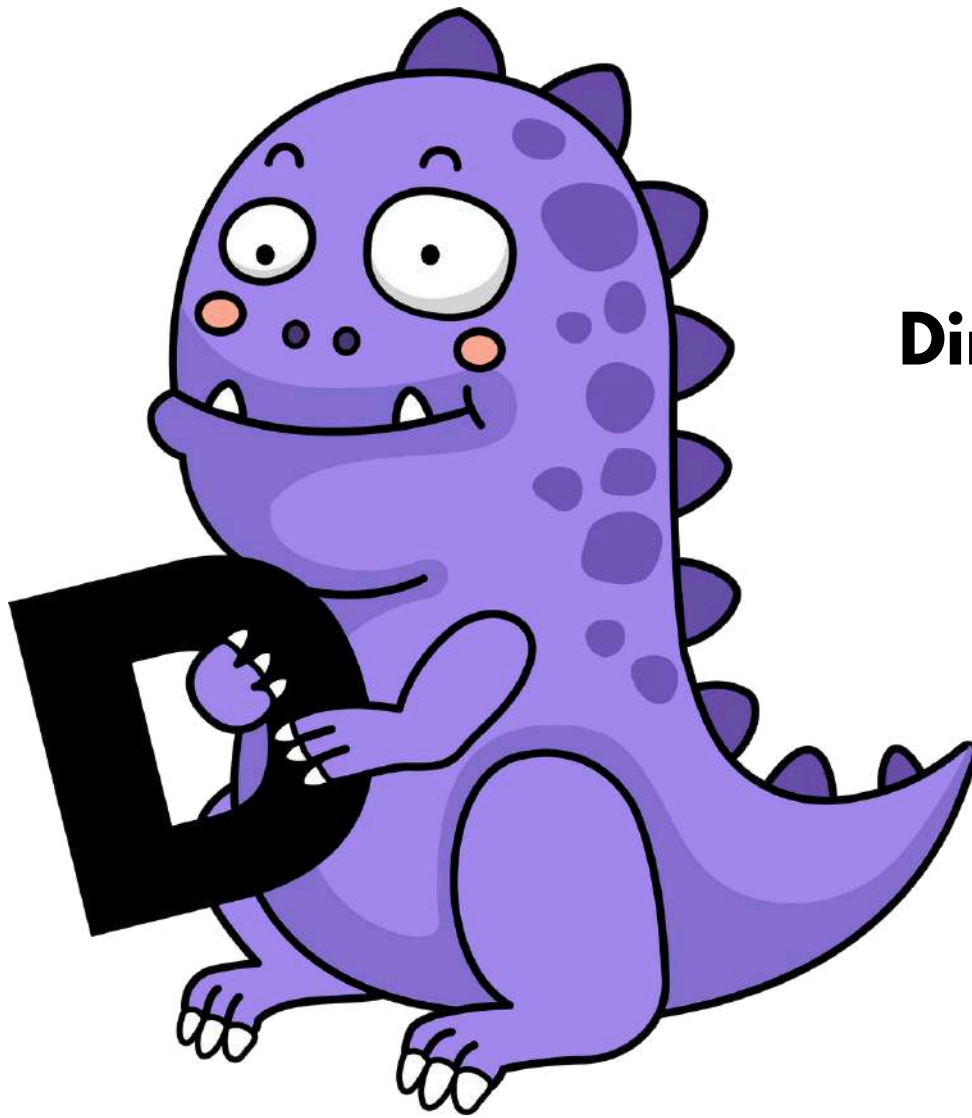

Dinosaur

