

Blue

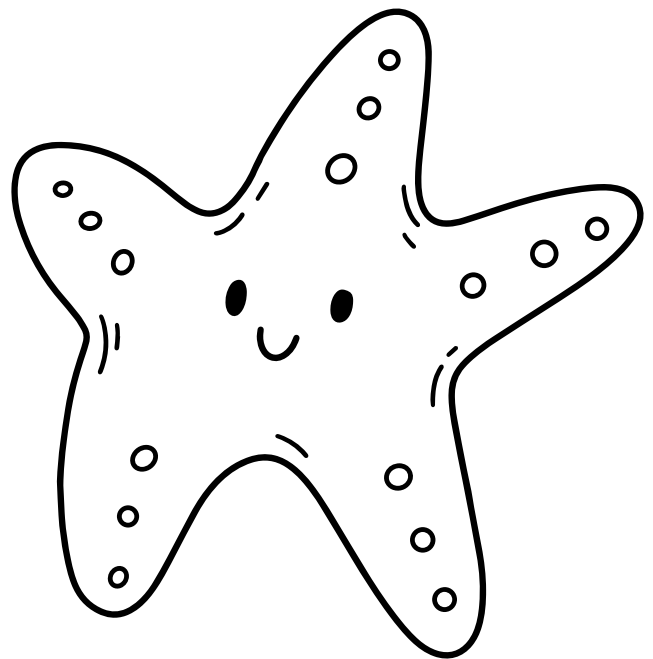

Blue

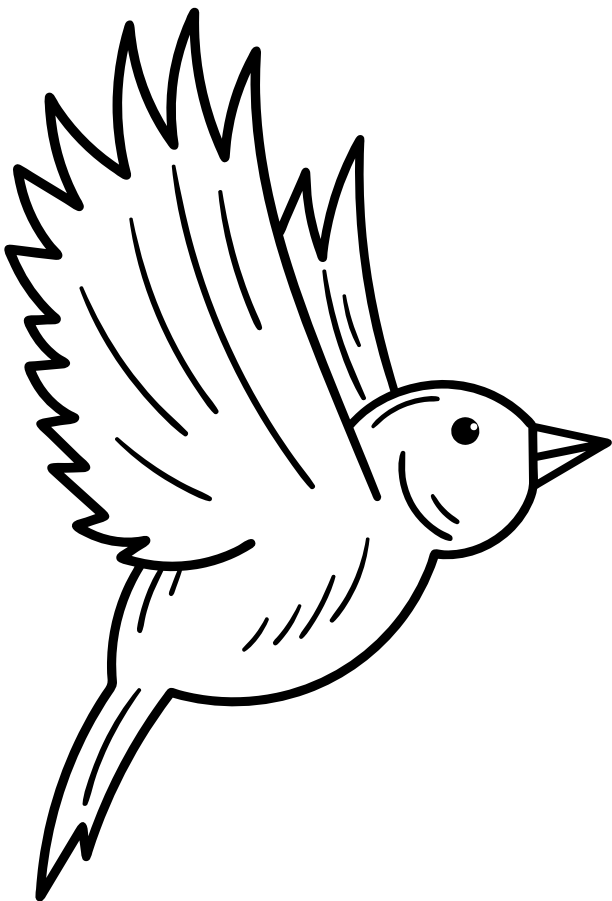
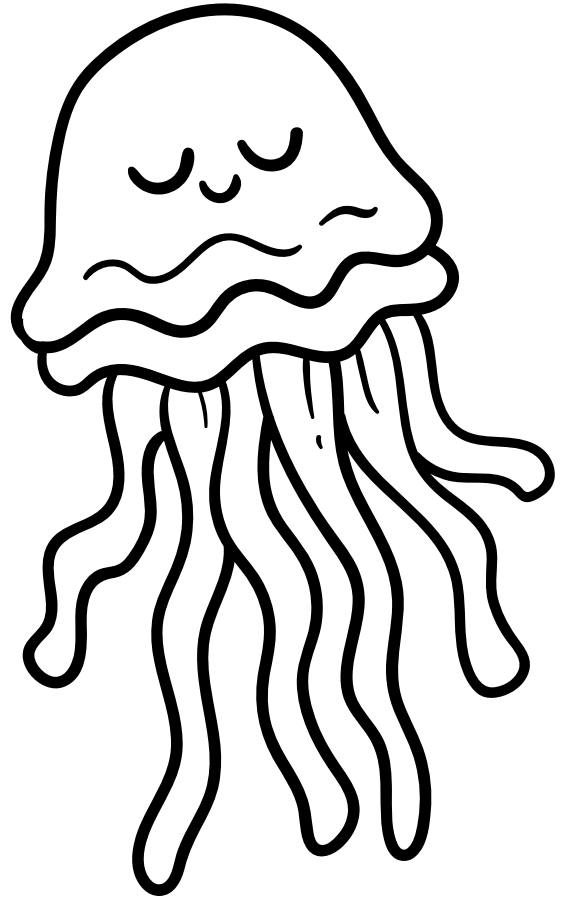
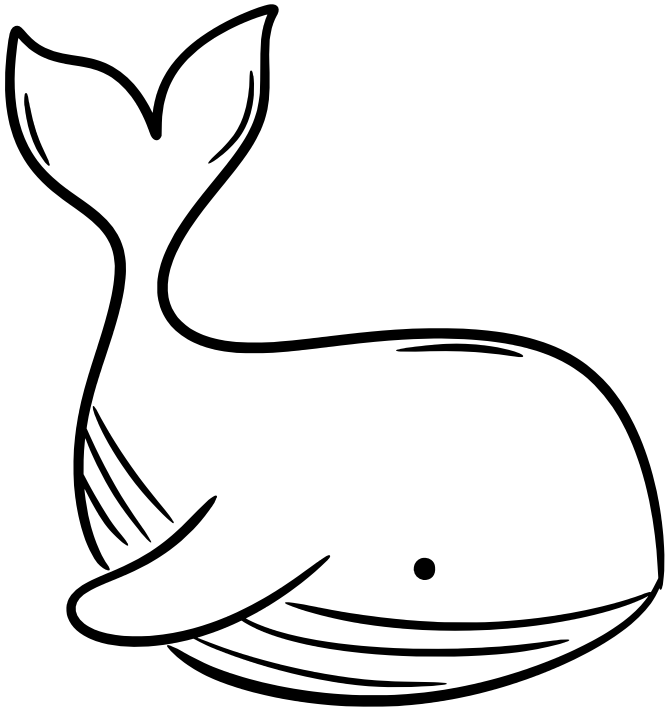
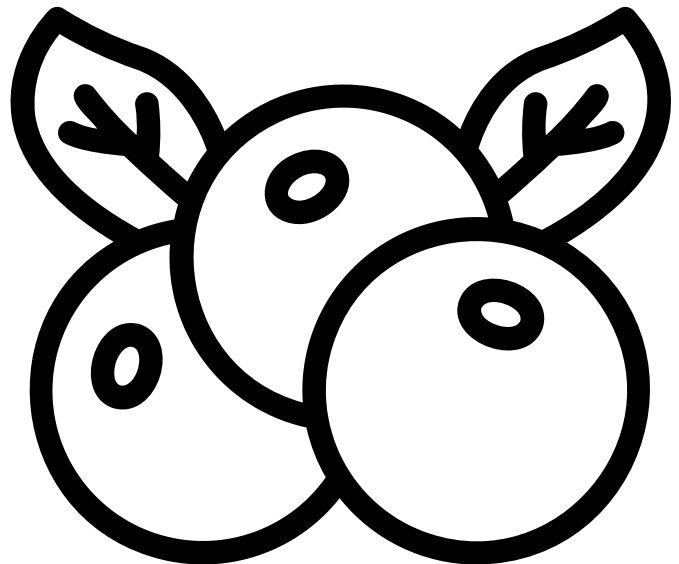
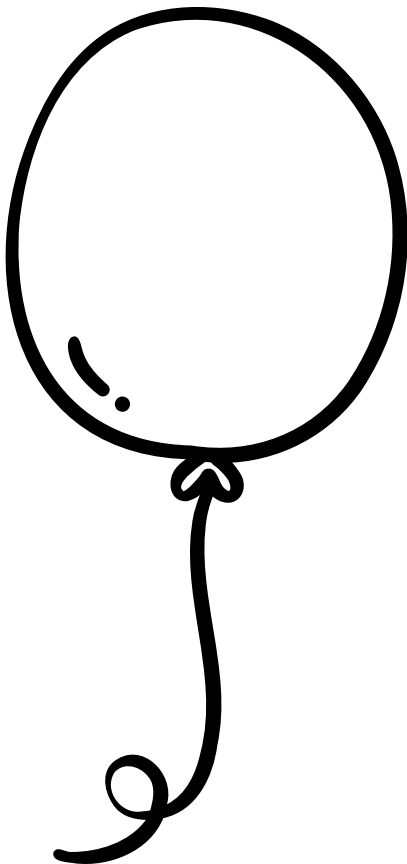
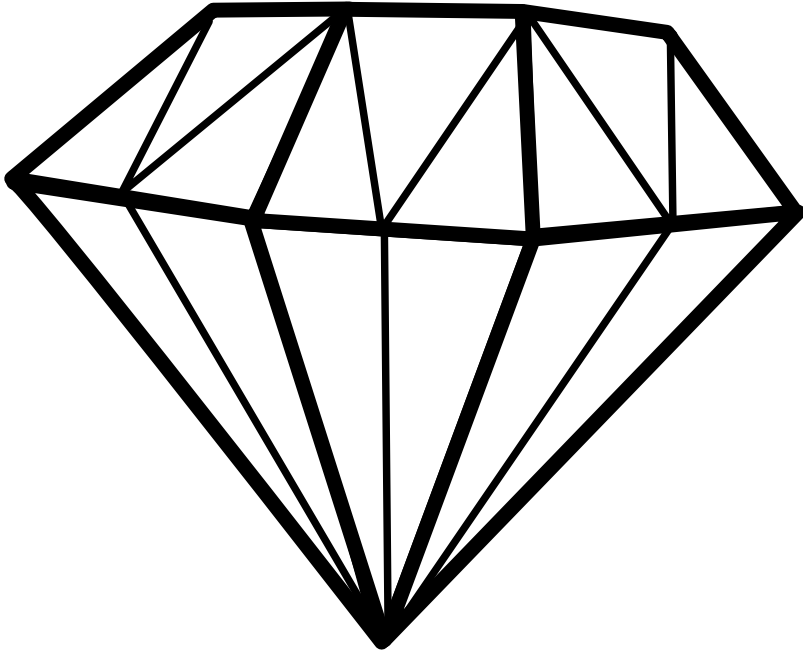

Learning Blue Color

blue notebook

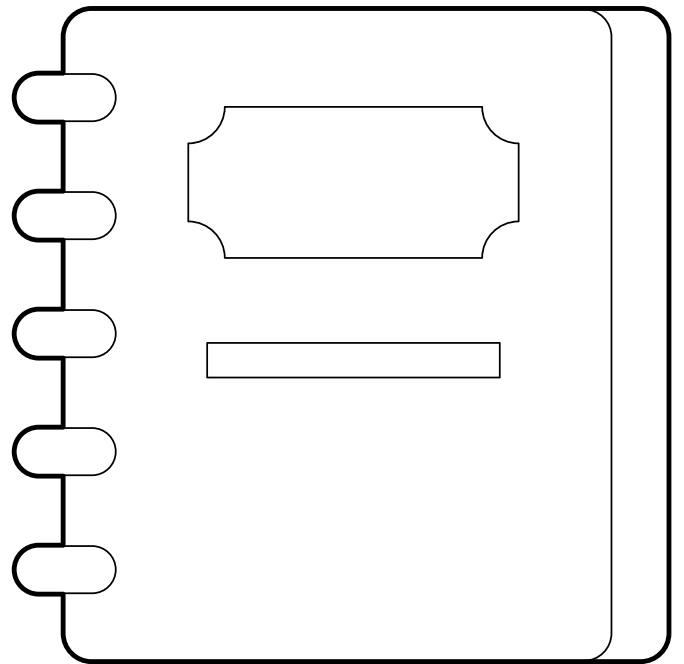
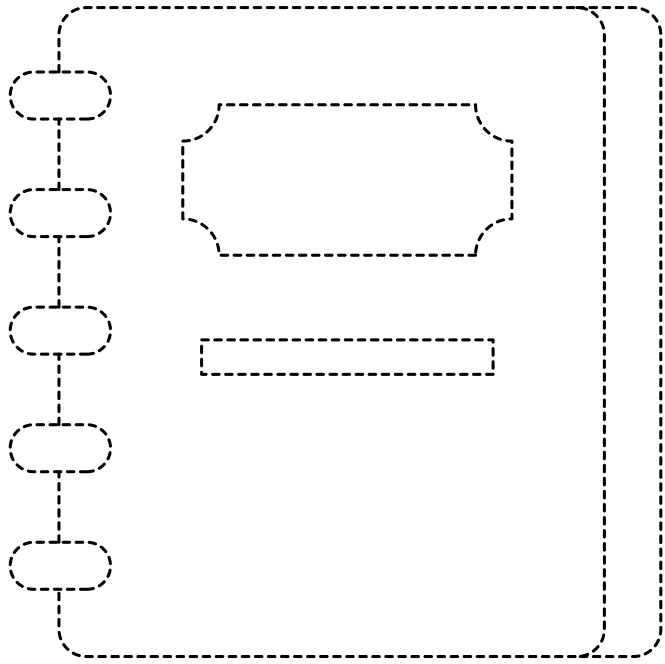

blue pencil

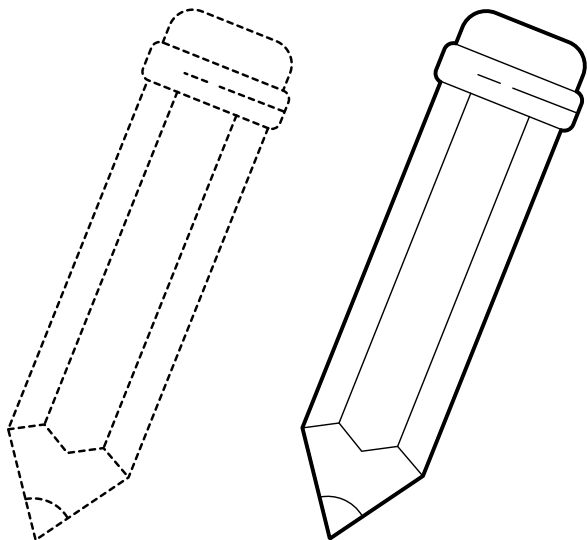

blue eraser

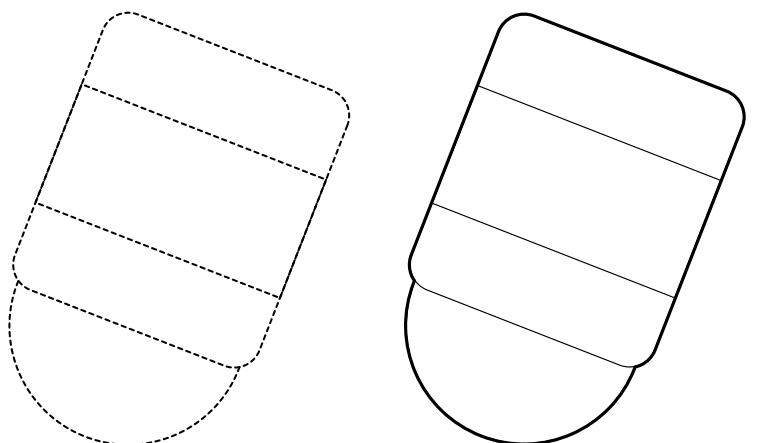

Learning Blue Color

blue pen

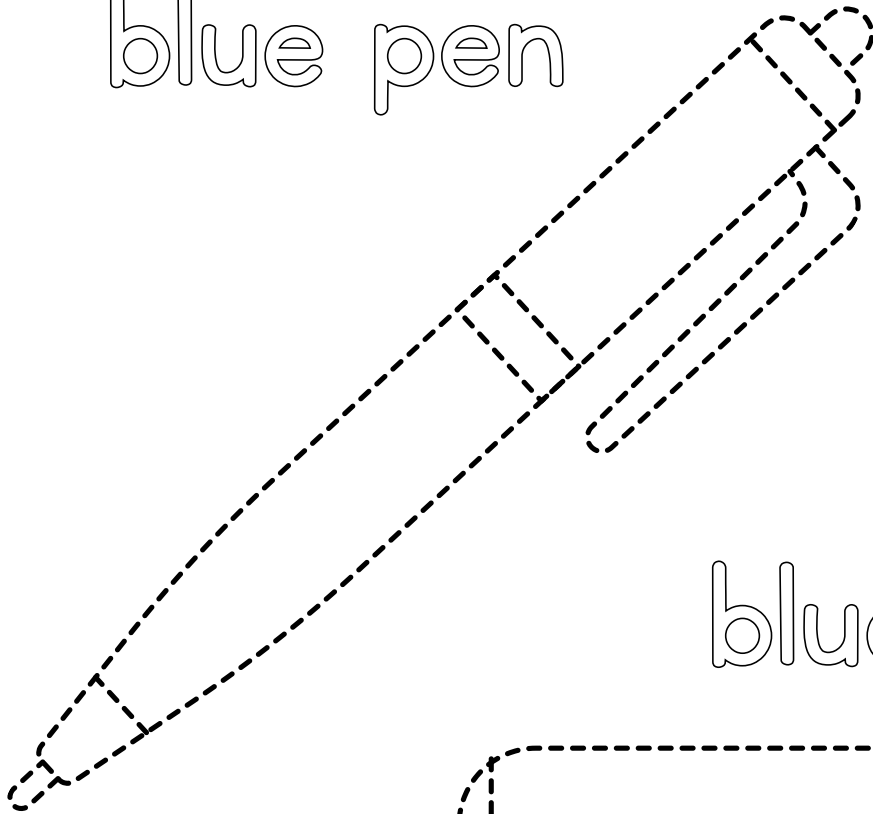

blue book

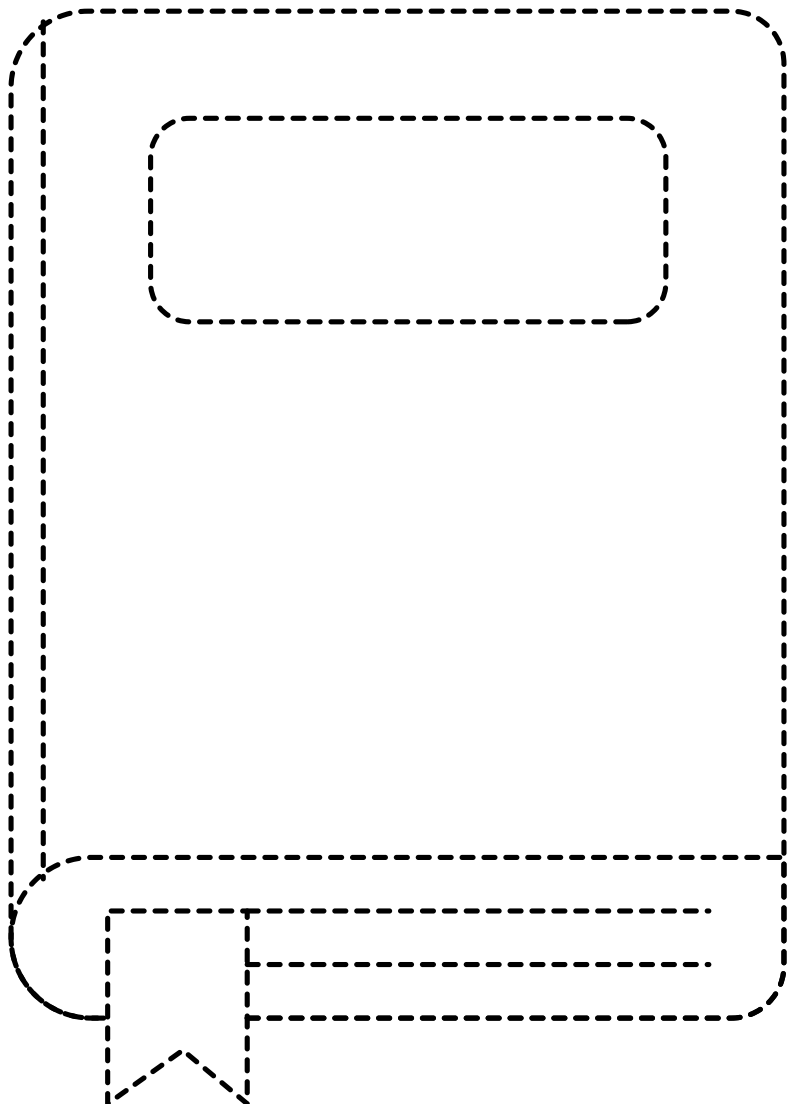

Learning Blue Color

Trace and color.

blue

rocket

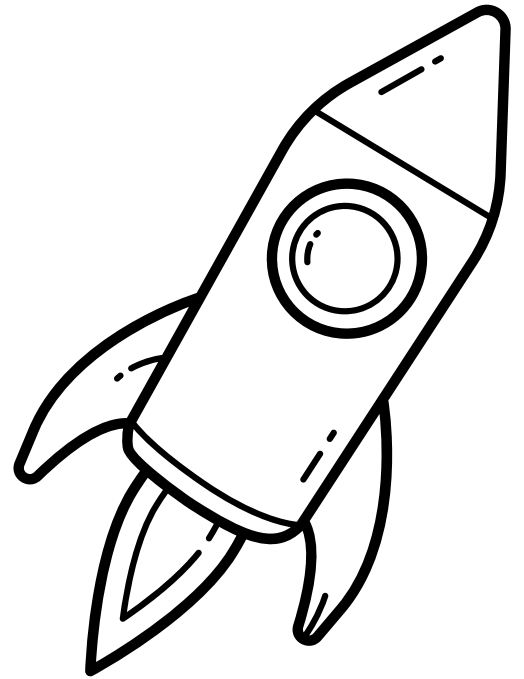

blue

astronaut

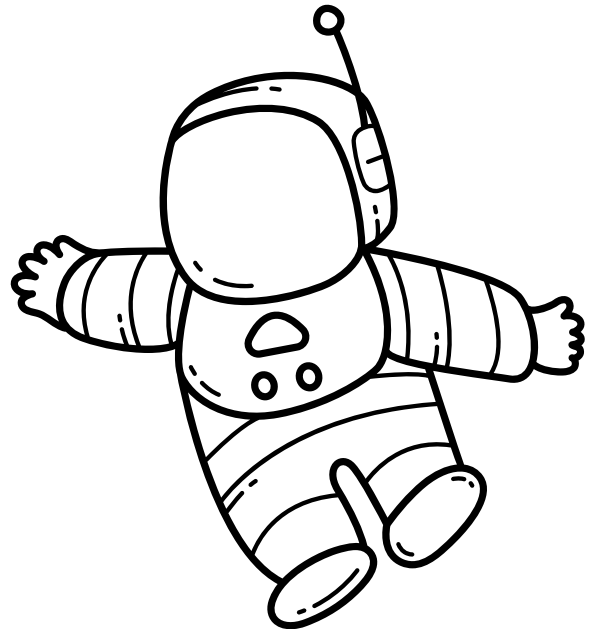

blue

robot

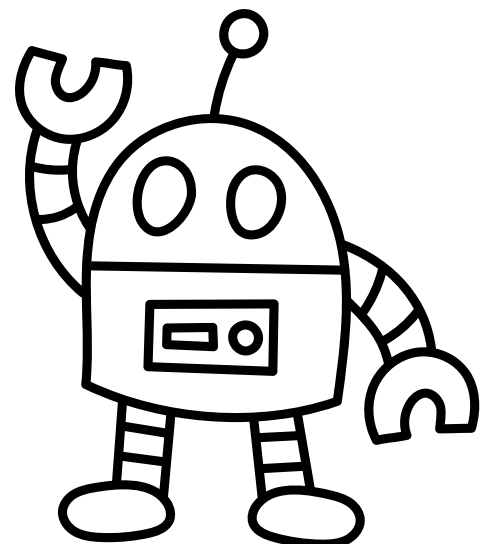

Learning Blue Color

whale

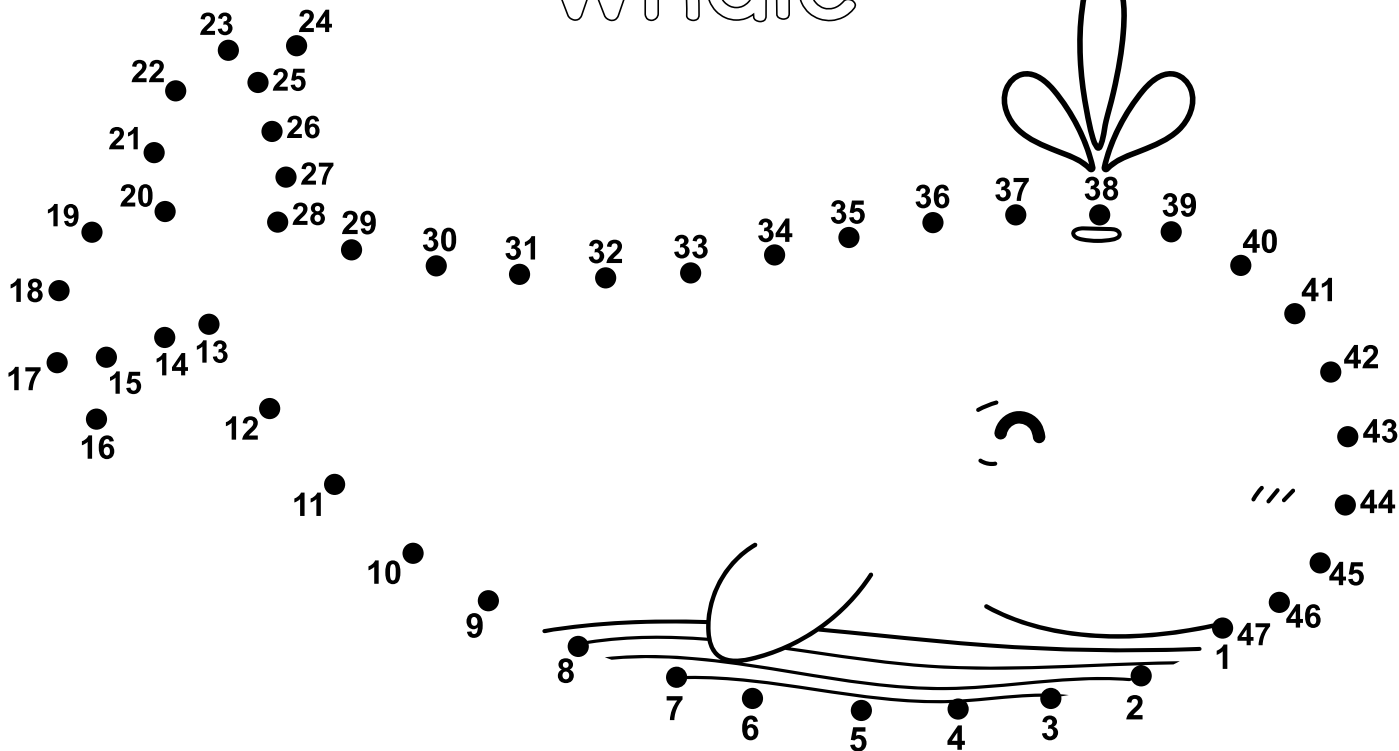

whale

whale

blue whale

blue whale

Learning Blue Color



bird

bird bird

bird bird

blue bird

blue bird

BLUE

Color the **greater** figure.

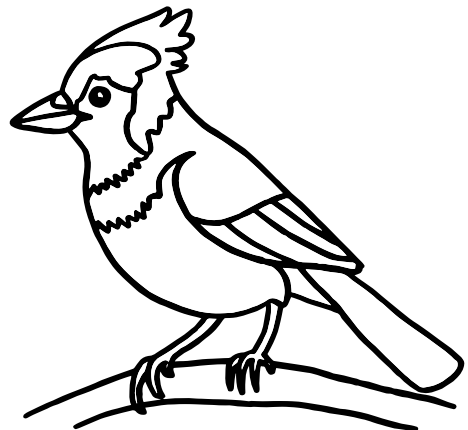
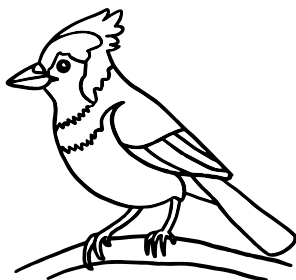
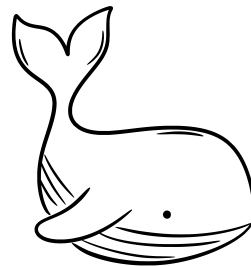
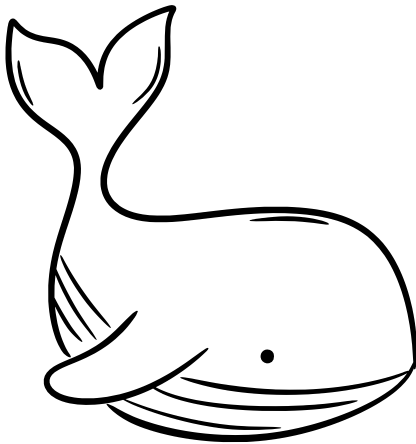
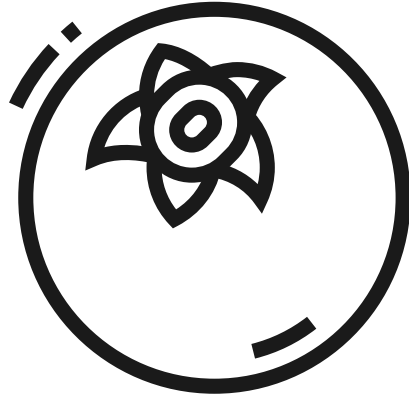
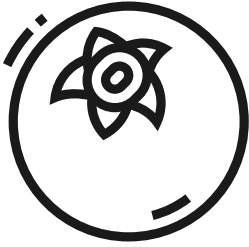

BLUE

Color the **smallest** figure.

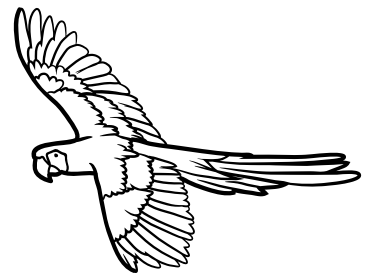
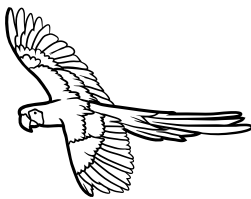
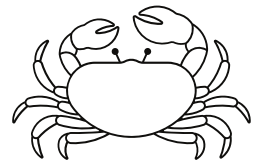
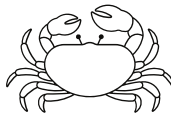
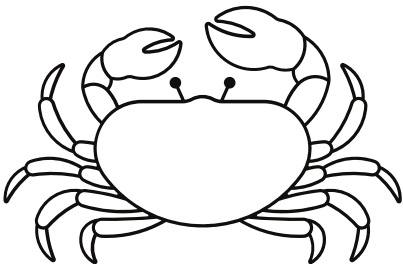
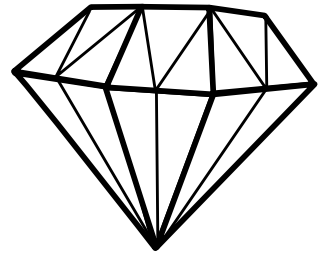
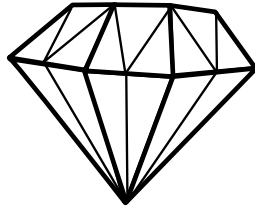
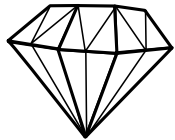

BLUE

Color the **odd** one out.

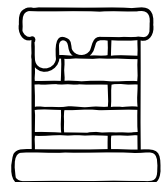
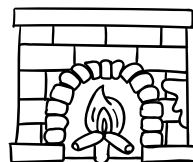
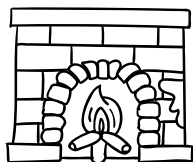
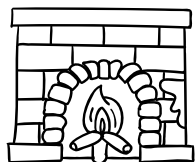
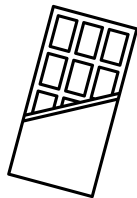
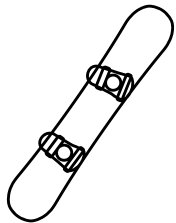

BLUE

What comes next?

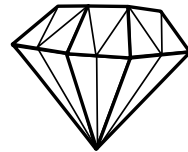
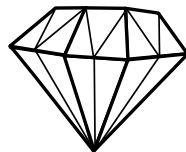
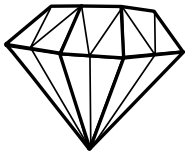
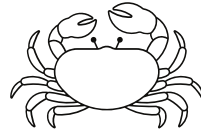
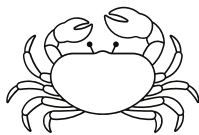
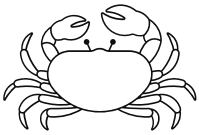
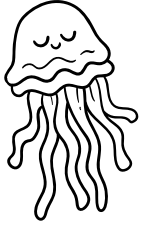
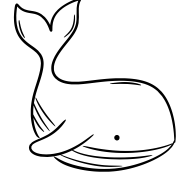
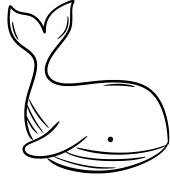
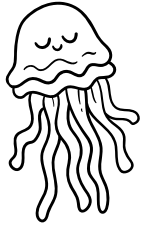
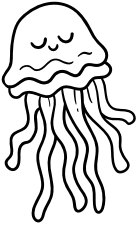

BLUE

Color the figures.

dolphin

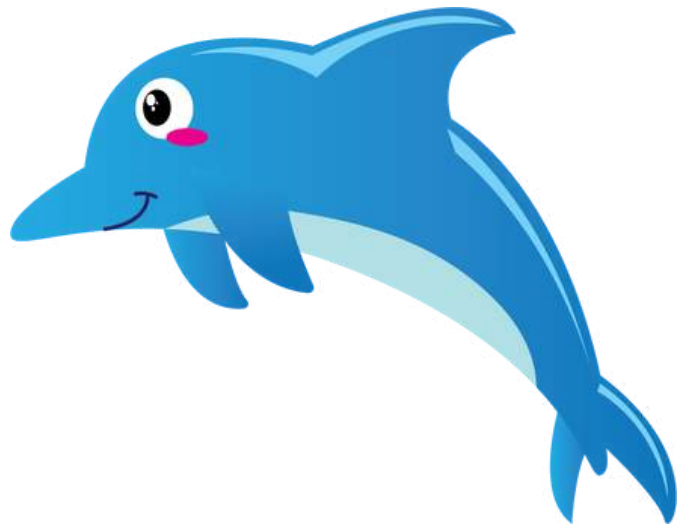
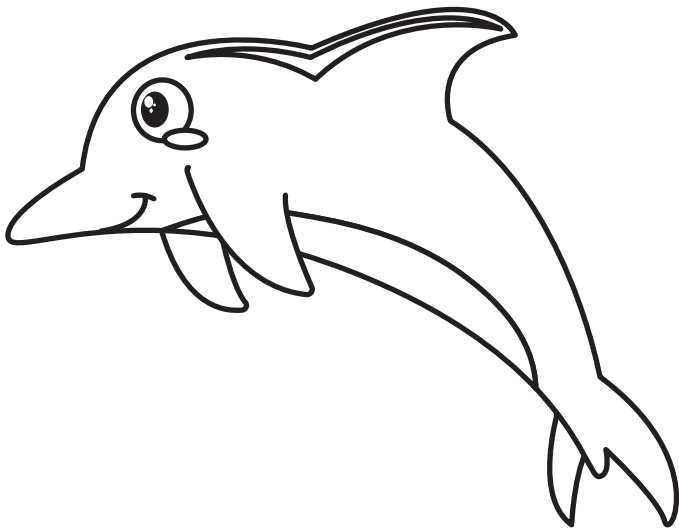

flower

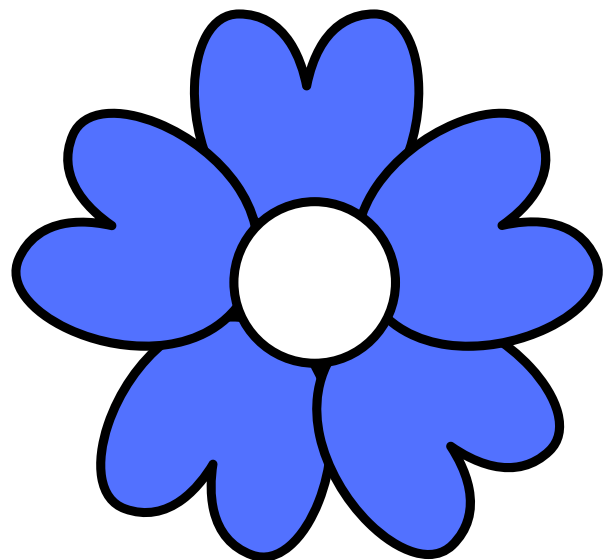
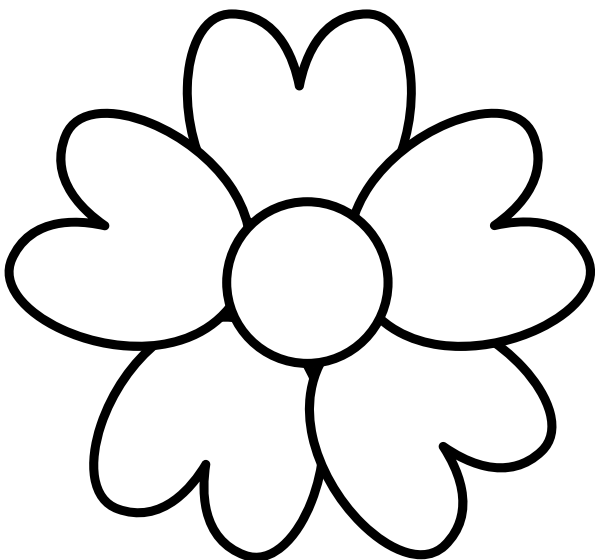

BLUE

Color and match.

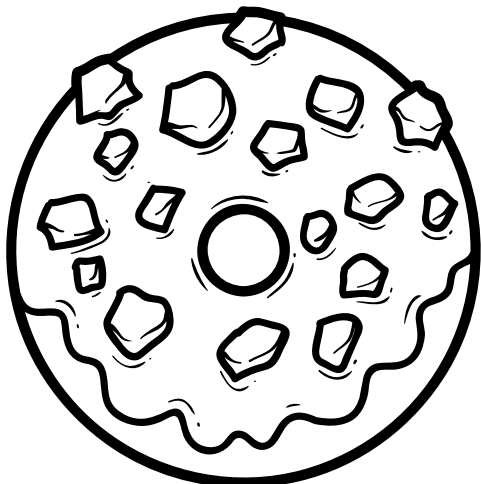
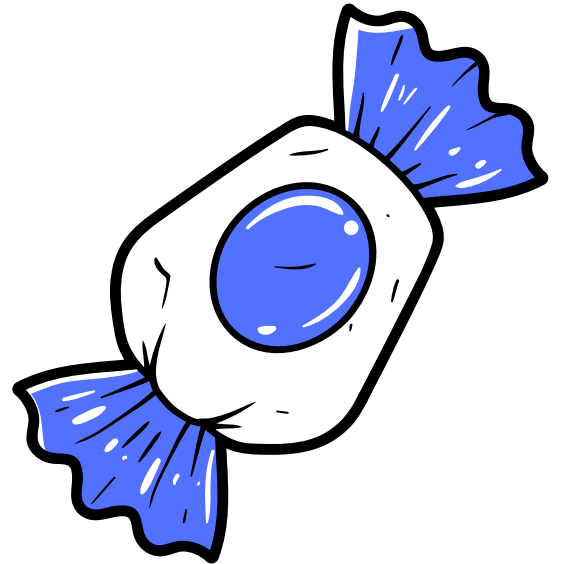
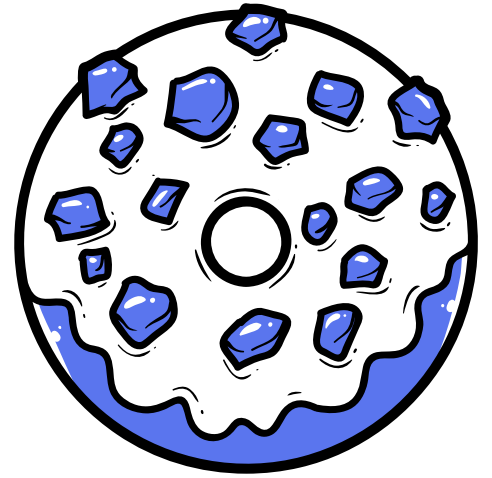
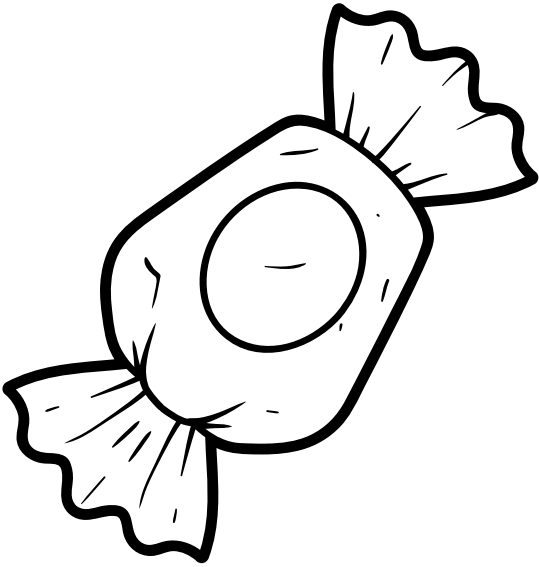

Blue

Blue

Blue

Blue

Blue

Blue

Blue

Circle the things that are blue.

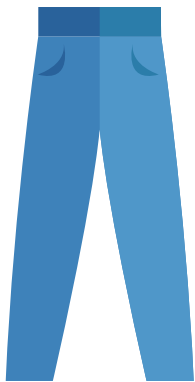
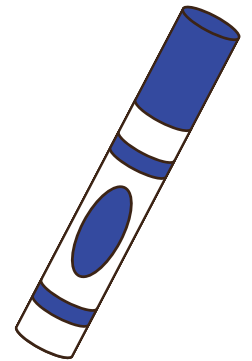
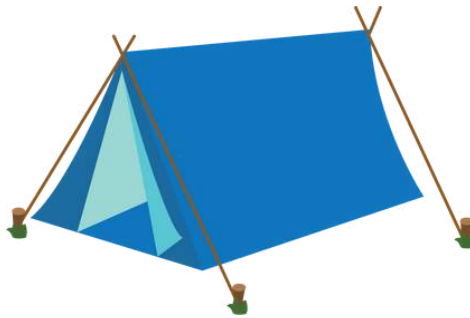

Find and color all the B's.

R

B

G

H

Z

G

B

V

B

N

S

R

B

E

C

B

H

B

A

N

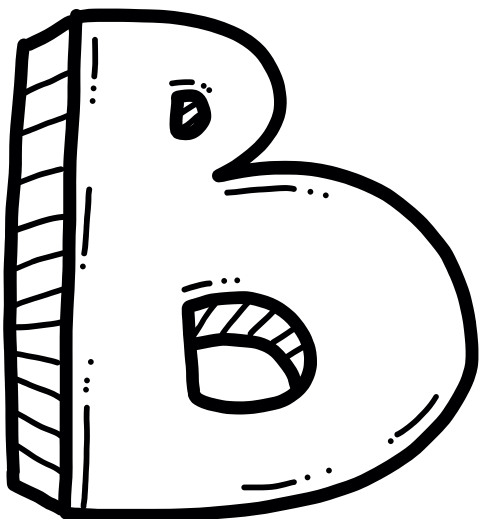

B is for Blue



Blue

Blue

Blue

Blue

Blue

Blue

Blue

blue

blue

blue

blue

blue

blue

blue

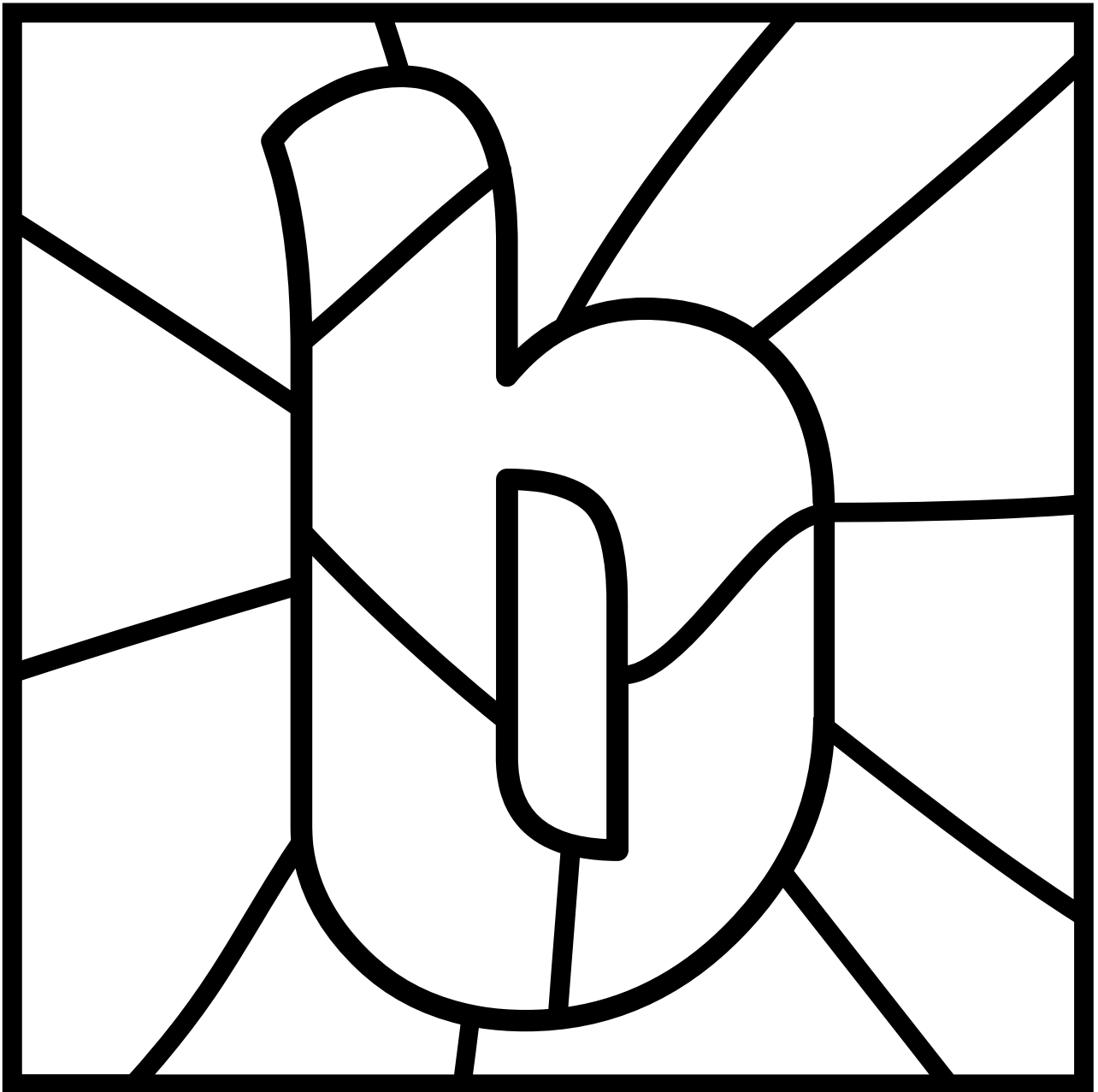

blue

blue

blue

blue

blue

blue

blue

blue

blue

blue

blue

blue

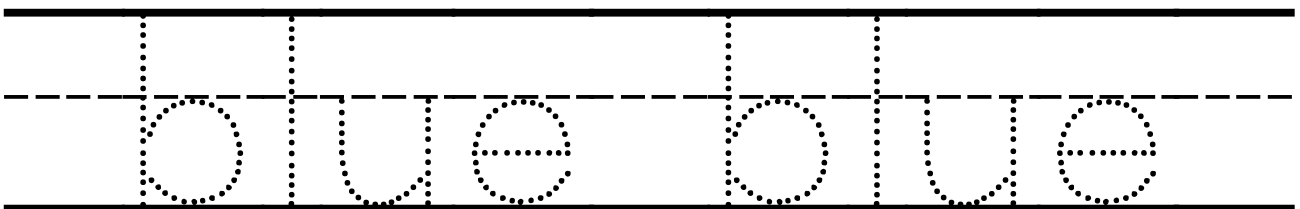
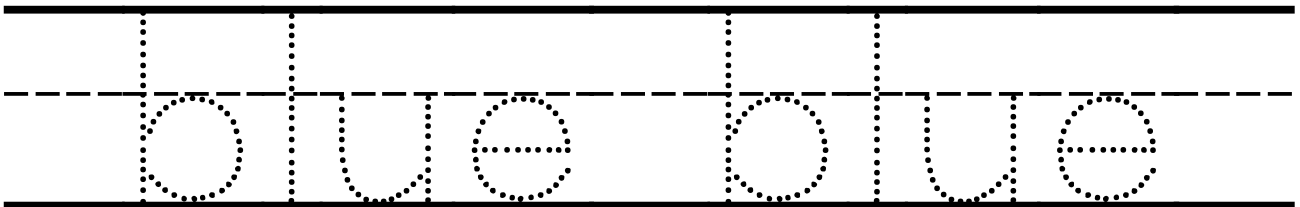
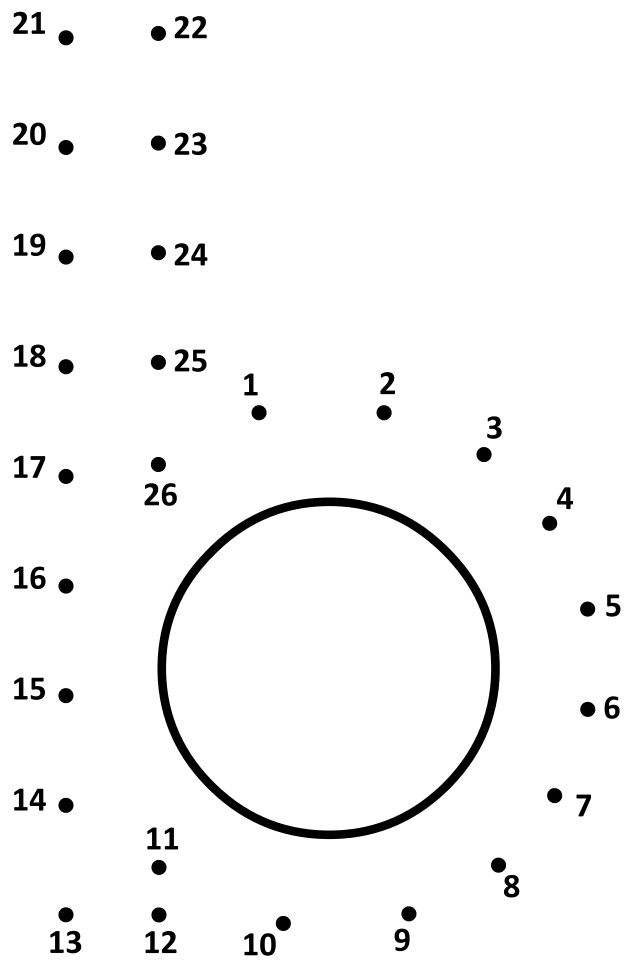

Can you spot the word "blue"?

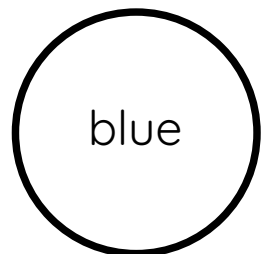
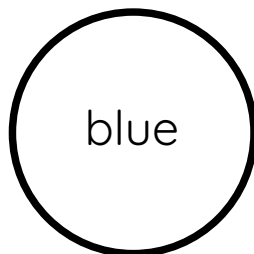
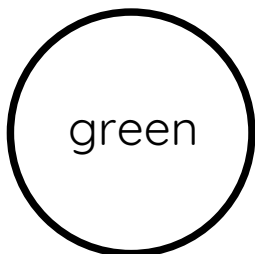
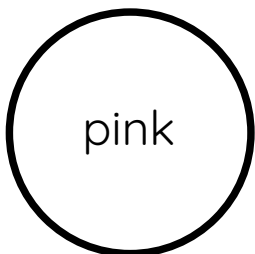
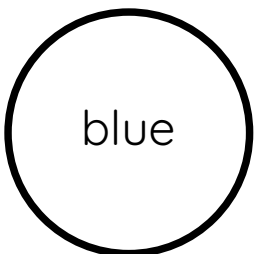

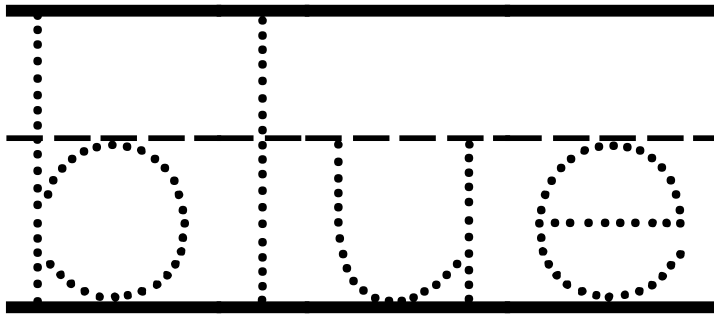

Trace and color.

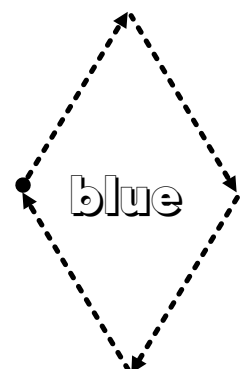
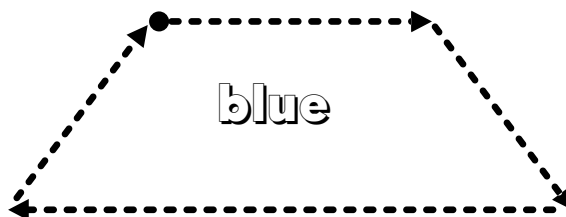
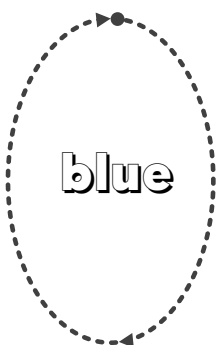
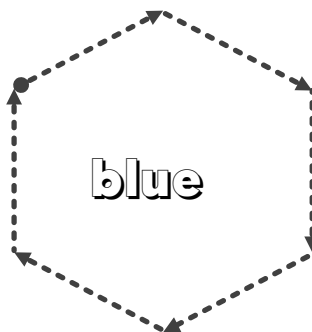
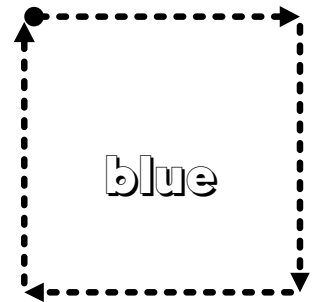
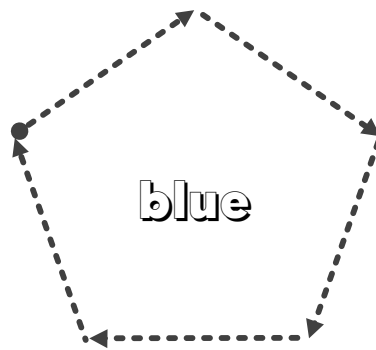
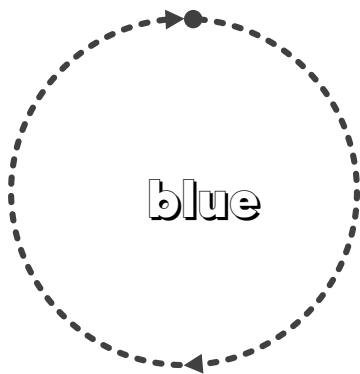
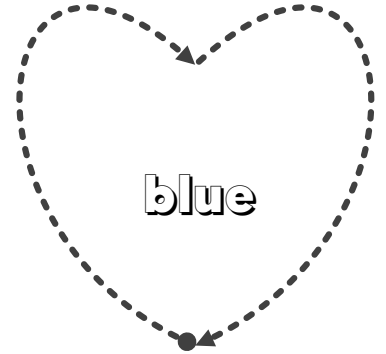
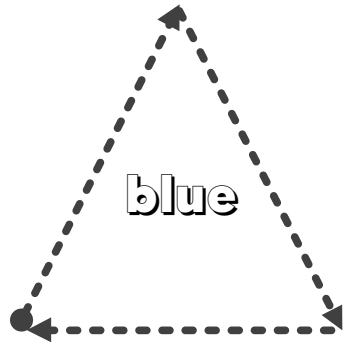
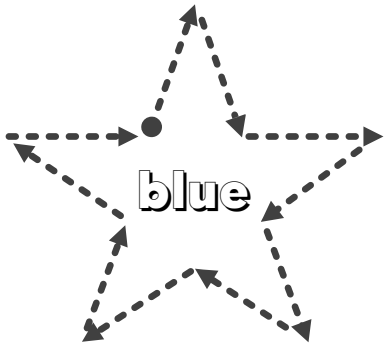

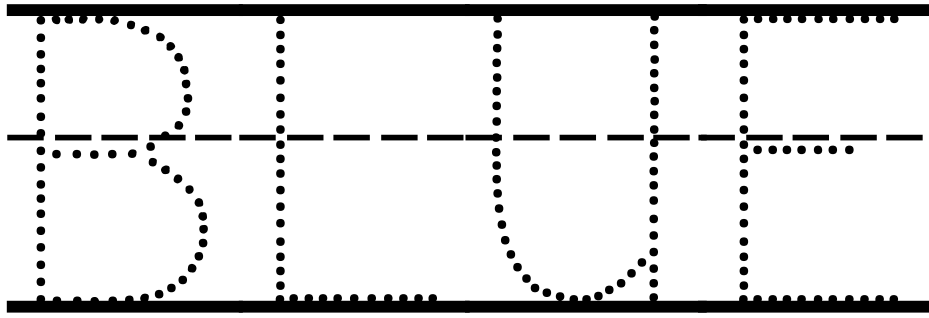

Color and cut.

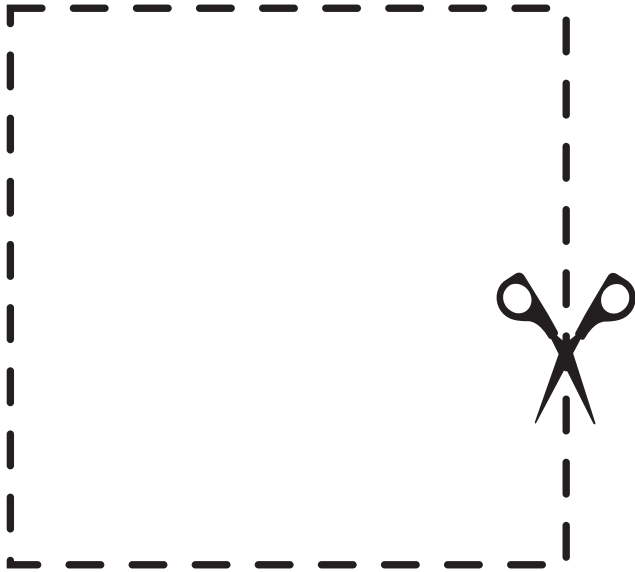

blue square

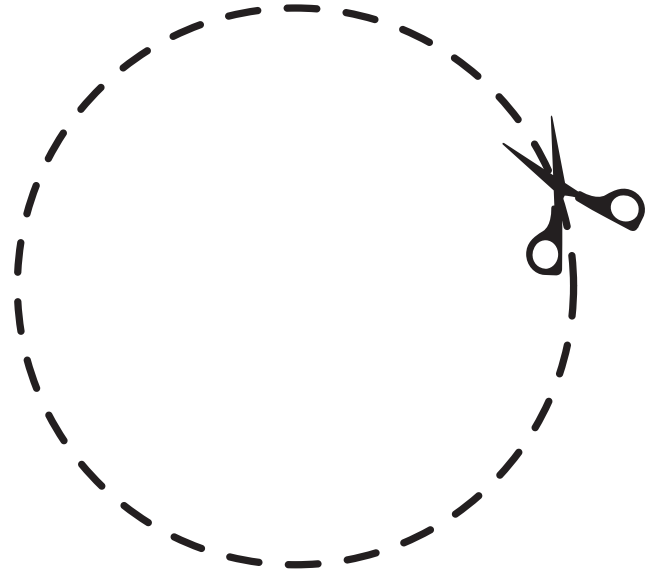

blue circle

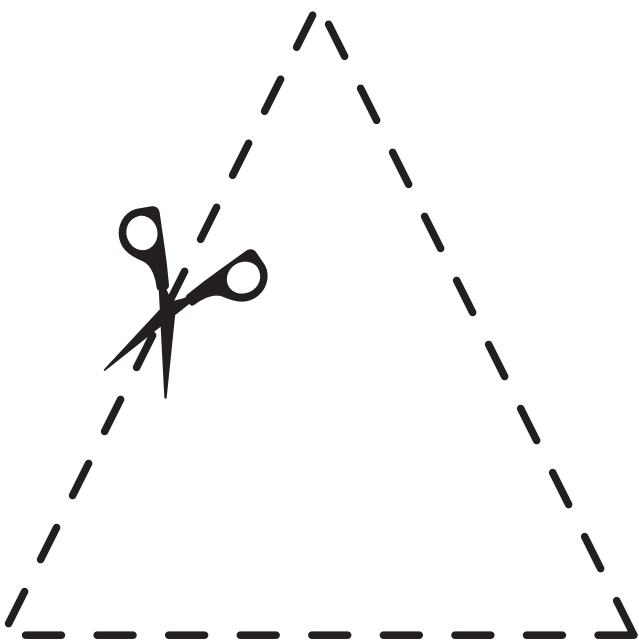

blue triangle

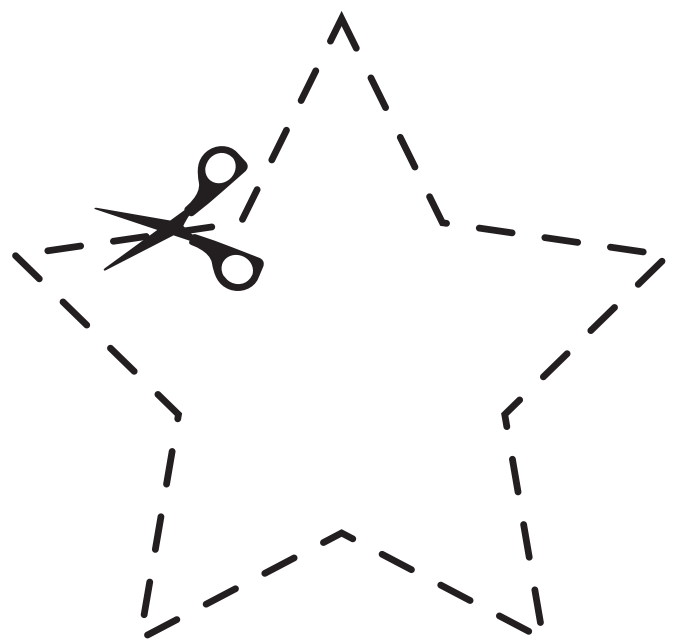

blue star

BLUE

Color the **odd** one out.

7
3
7

9
9
2

6
6
5

8
1
8

3
3
4

7
5
5

2
2
8

1
9
1

6
4
4

BLUE

Count and color.

2

blue
blue

blue
blue

blue
blue

4

blue
blue

blue
blue

blue
blue

1

blue
blue

blue
blue

blue
blue

3

blue
blue

blue
blue

blue
blue

5

blue
blue

blue
blue

blue
blue

BLUE

Color the **odd** one out.

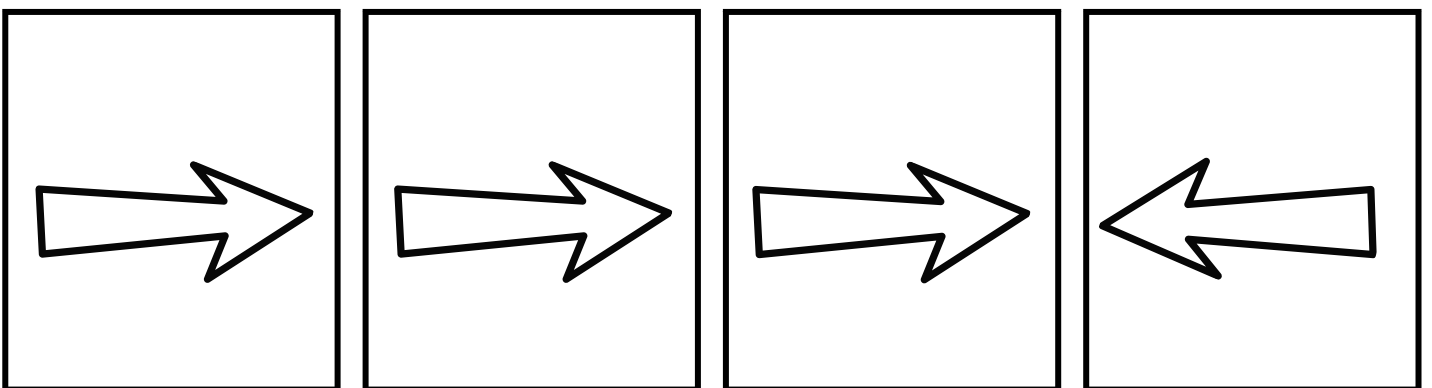
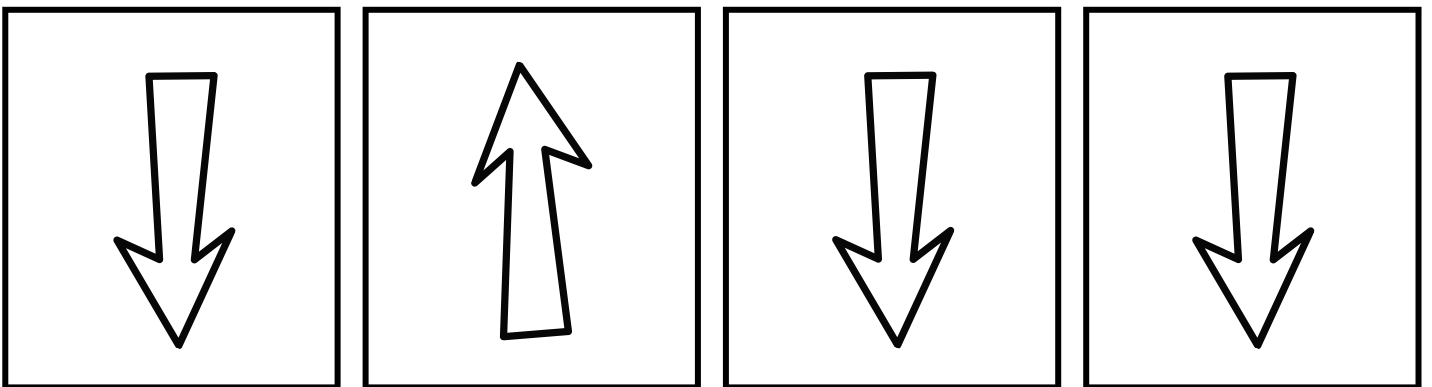
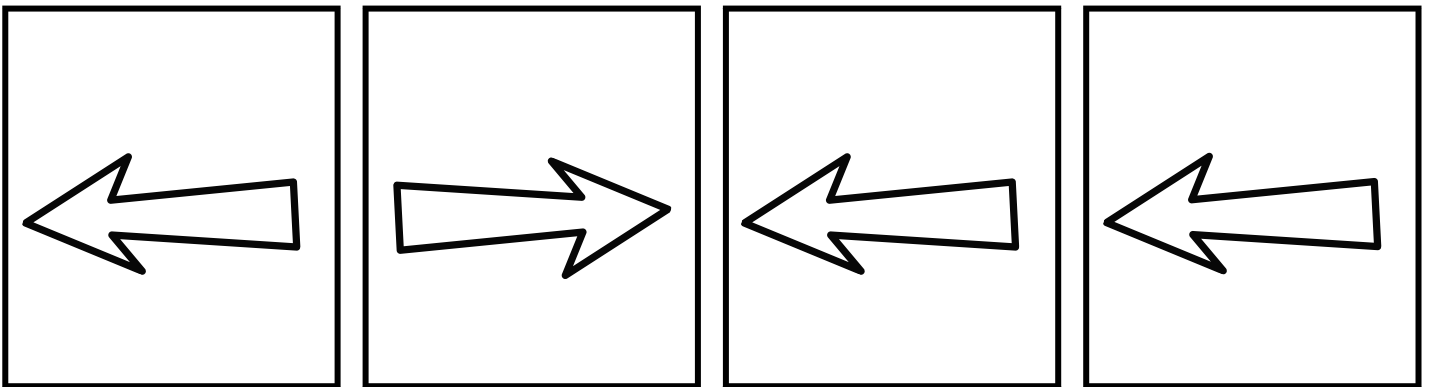
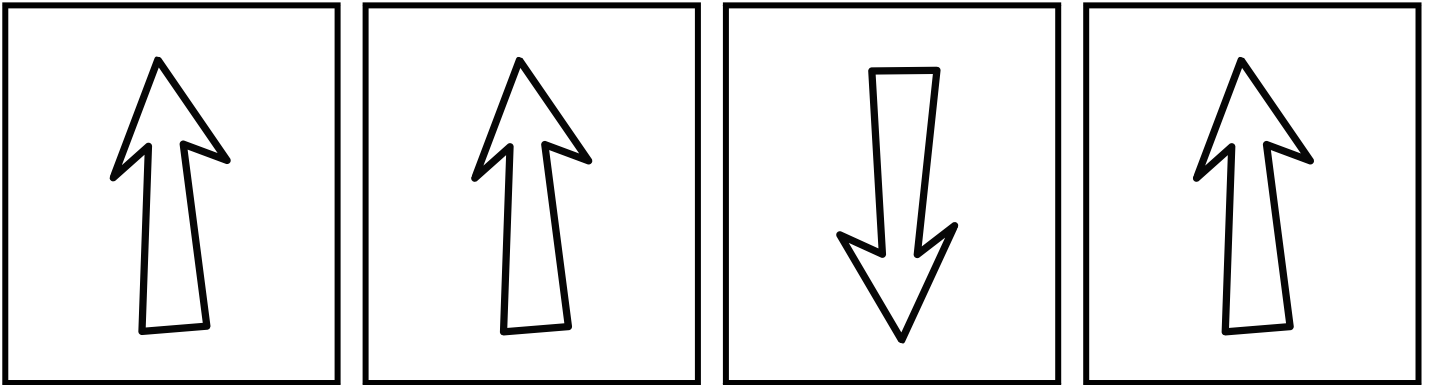

BLUE

Color the correct shape.

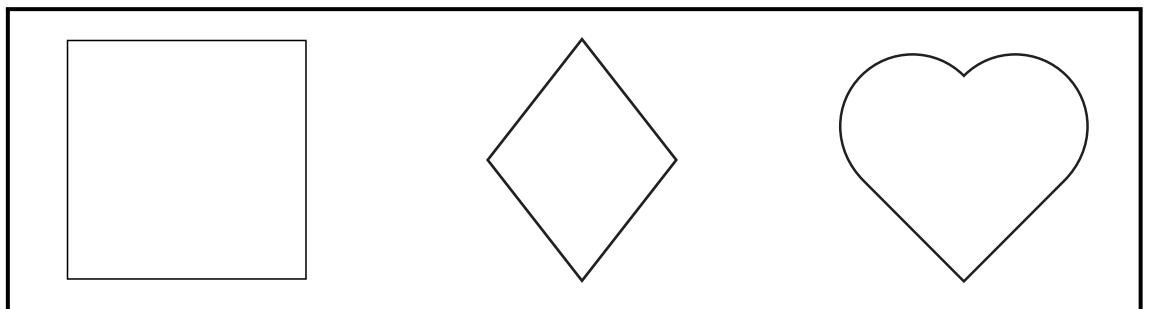
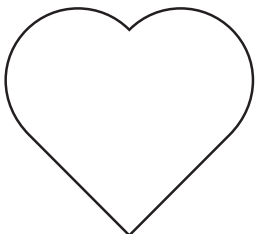
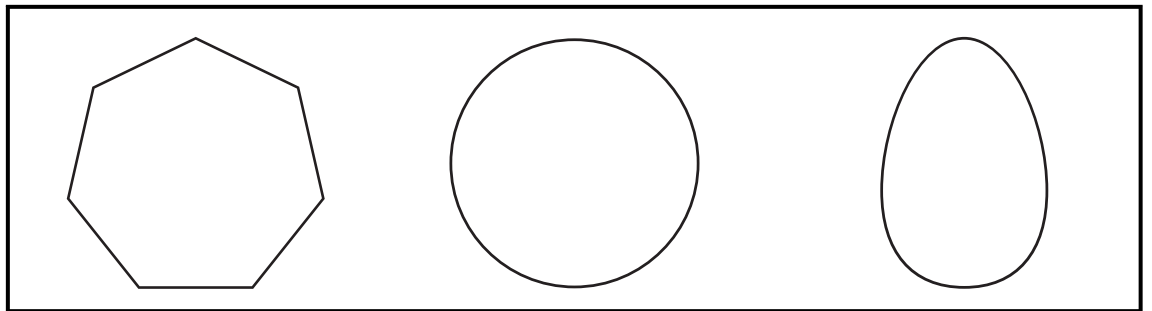
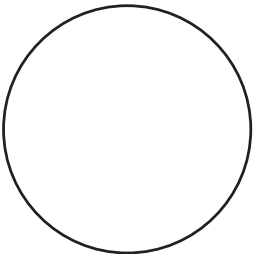
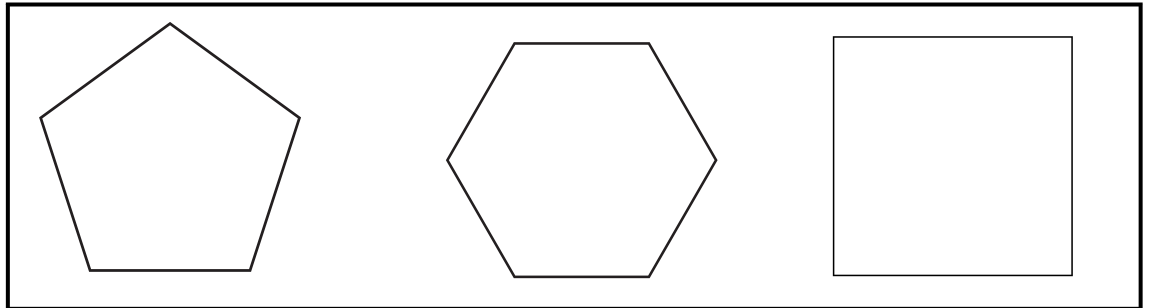
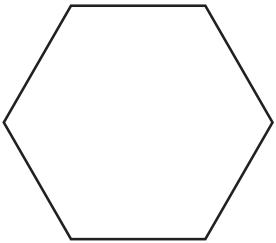
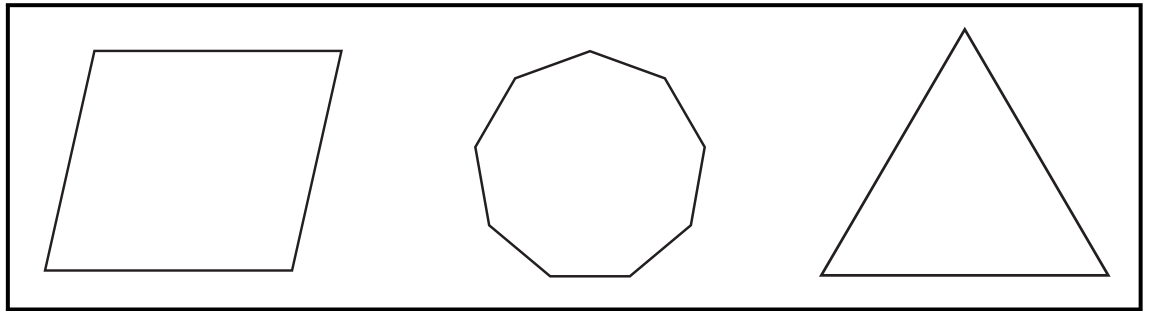
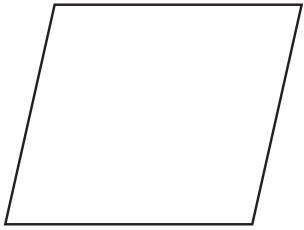
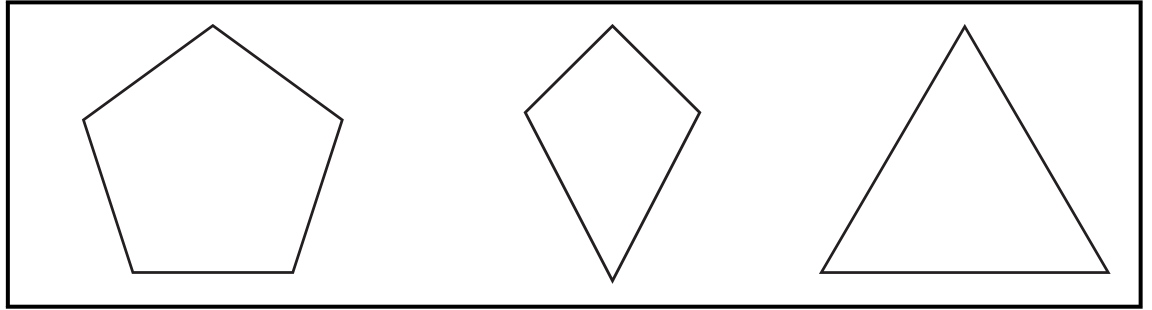
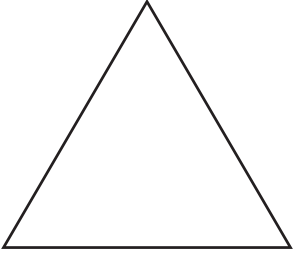

BLUE

Color the shapes.

first

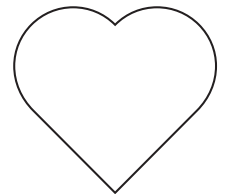
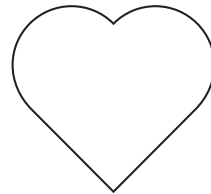
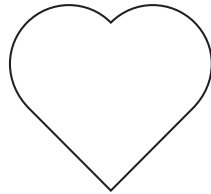
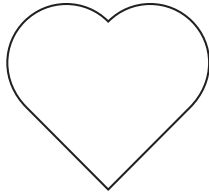

second

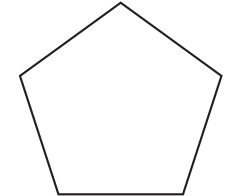
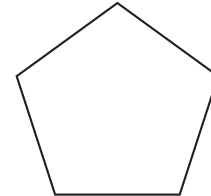
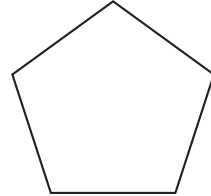
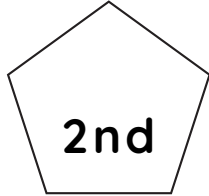
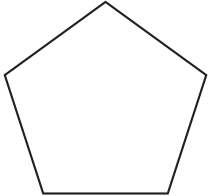

third

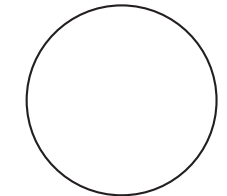
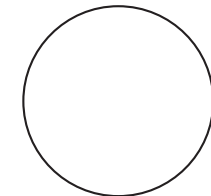
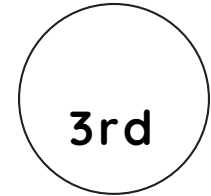
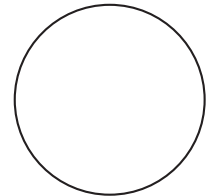
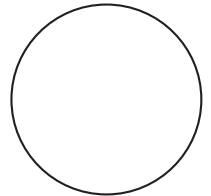

fourth

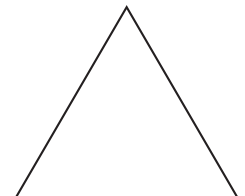
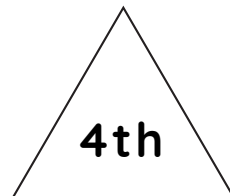
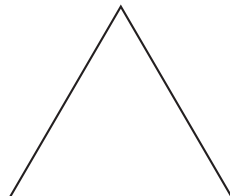
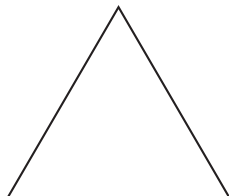
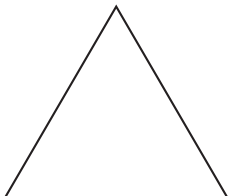

fifth

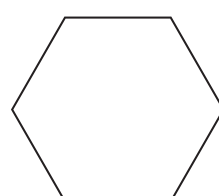
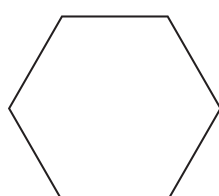
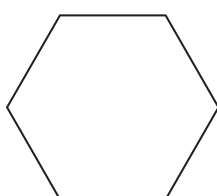
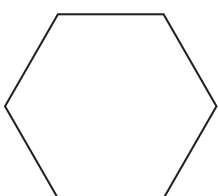

Learning Blue Color

Paint all the odd numbers blue.

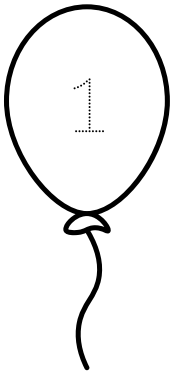

one

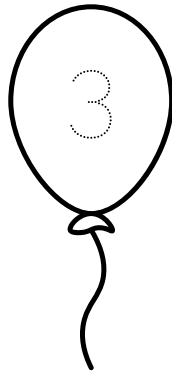
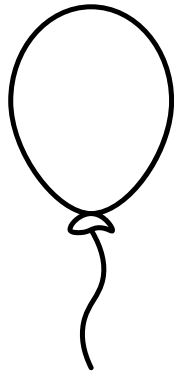

three

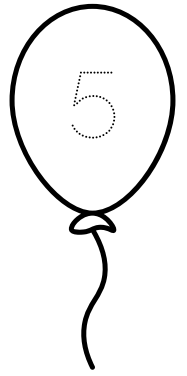
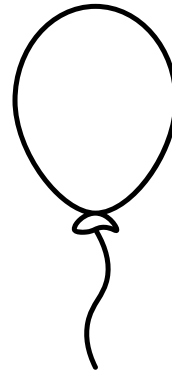

five

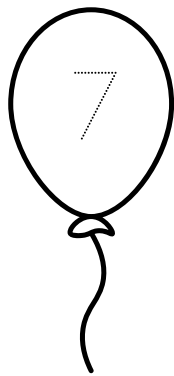
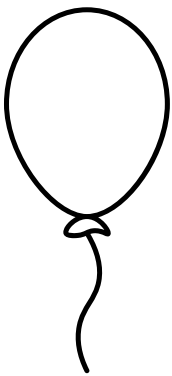

seven

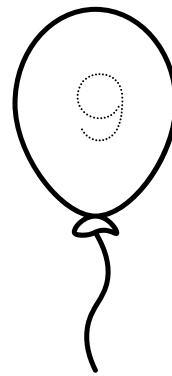
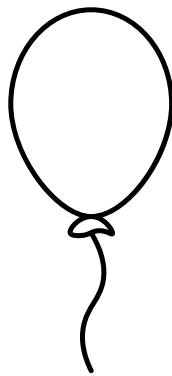

nine

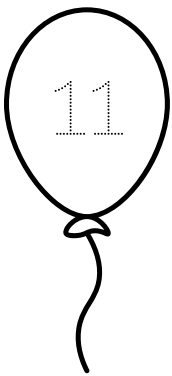
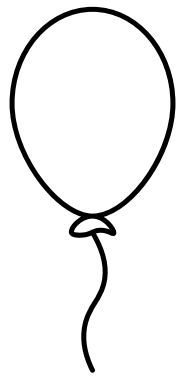

eleven

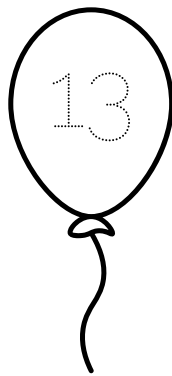
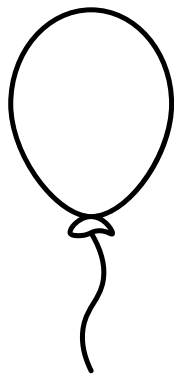

thirteen

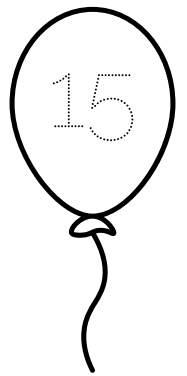
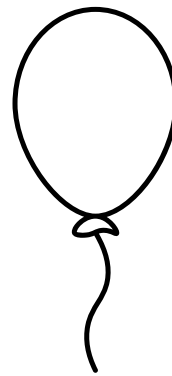

fifteen

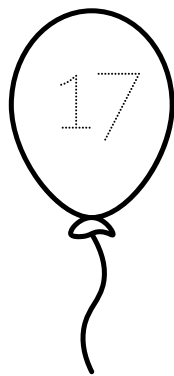
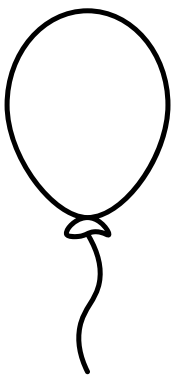

seventeen

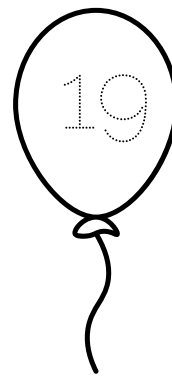
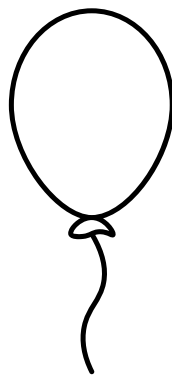

nineteen

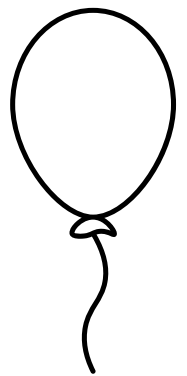

Learning Blue Color

Paint all the even numbers blue.

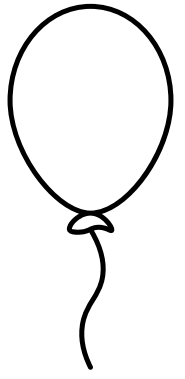
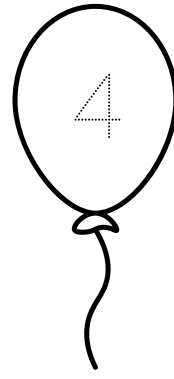
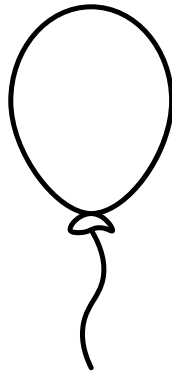
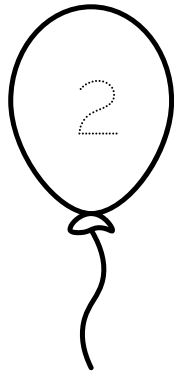
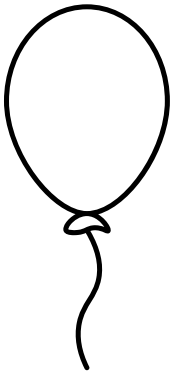

two

four

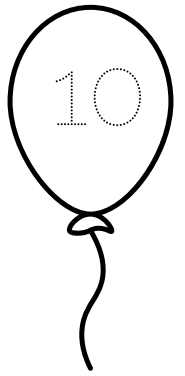
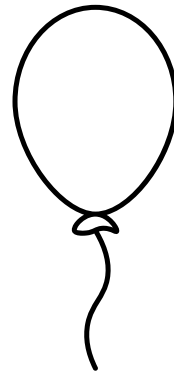
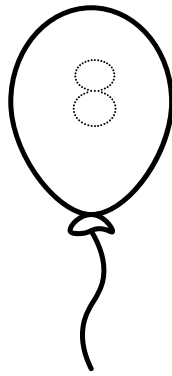
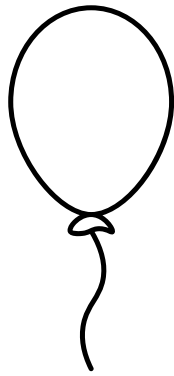
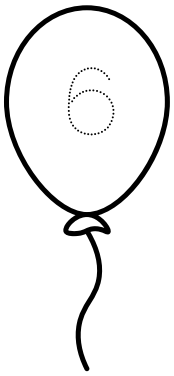

six

eight

ten

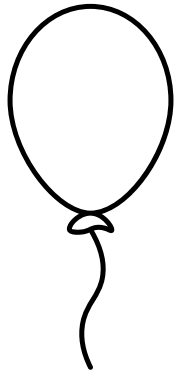
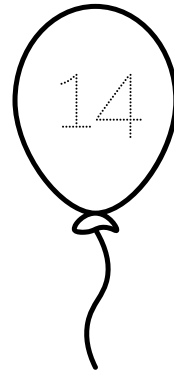
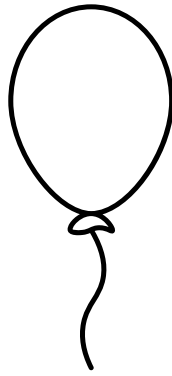
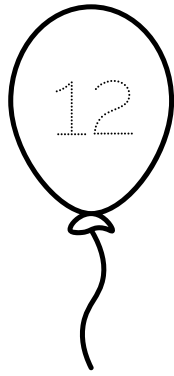
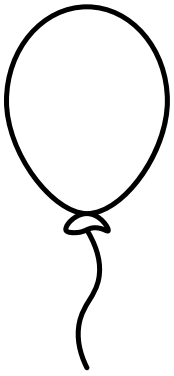

twelve

fourteen

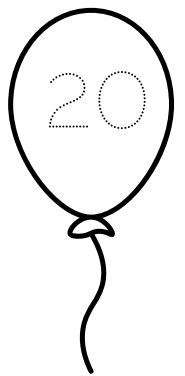
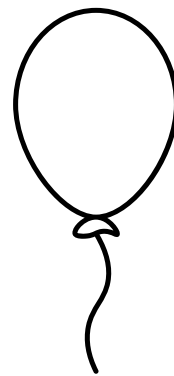
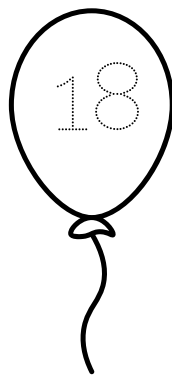
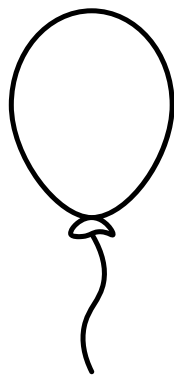
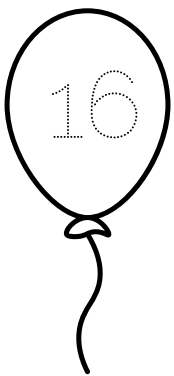

sixteen

eighteen

twenty